

Precision Strain Gages and Sensors

Databook

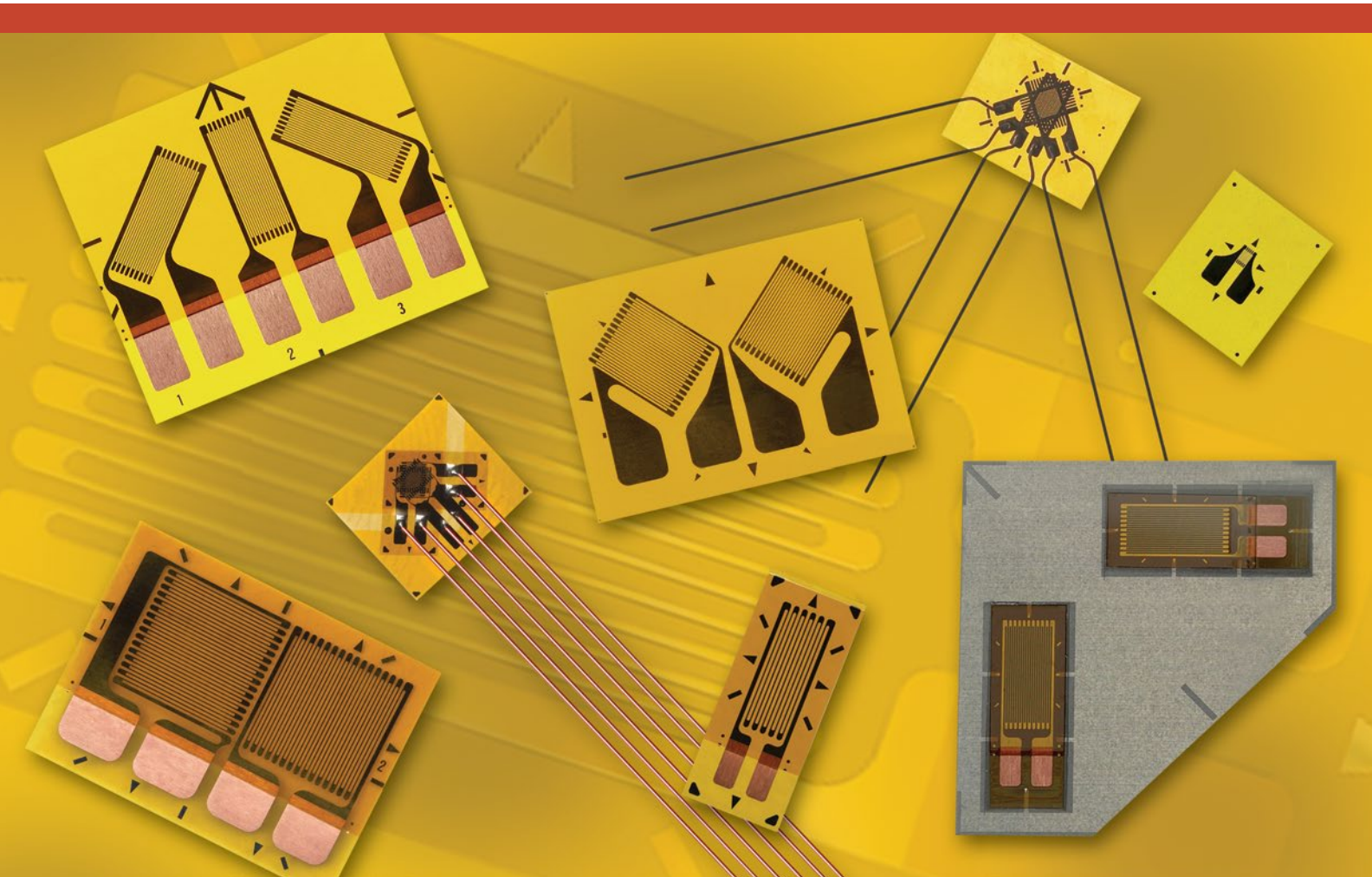

General Purpose
Special Purpose
Weldable
Temperature Sensors
Residual Stress

Precision Strain Gages and Sensors

Micro-Measurements

P.O. Box 27777

Raleigh, NC 27611

U.S.A.

PH: +1-919-365-3800

FAX: +1-919-365-3945

www.micro-measurements.com

Disclaimer

ALL PRODUCTS, PRODUCT SPECIFICATIONS AND DATA ARE SUBJECT TO CHANGE WITHOUT NOTICE.

Vishay Precision Group, Inc., its affiliates, agents, and employees, and all persons acting on its or their behalf (collectively, "VPG"), disclaim any and all liability for any errors, inaccuracies or incompleteness contained herein or in any other disclosure relating to any product.

The product specifications do not expand or otherwise modify VPG's terms and conditions of purchase, including but not limited to, the warranty expressed therein.

VPG makes no warranty, representation or guarantee other than as set forth in the terms and conditions of purchase. **To the maximum extent permitted by applicable law, VPG disclaims (i) any and all liability arising out of the application or use of any product, (ii) any and all liability, including without limitation special, consequential or incidental damages, and (iii) any and all implied warranties, including warranties of fitness for particular purpose, non-infringement and merchantability.**

Information provided in datasheets and/or specifications may vary from actual results in different applications and performance may vary over time. Statements regarding the suitability of products for certain types of applications are based on VPG's knowledge of typical requirements that are often placed on VPG products. It is the customer's responsibility to validate that a particular product with the properties described in the product specification is suitable for use in a particular application. You should ensure you have the current version of the relevant information by contacting VPG prior to performing installation or use of the product, such as on our website at vpgsensors.com.

No license, express, implied, or otherwise, to any intellectual property rights is granted by this document, or by any conduct of VPG.

The products shown herein are not designed for use in life-saving or life-sustaining applications unless otherwise expressly indicated. Customers using or selling VPG products not expressly indicated for use in such applications do so entirely at their own risk and agree to fully indemnify VPG for any damages arising or resulting from such use or sale. Please contact authorized VPG personnel to obtain written terms and conditions regarding products designed for such applications.

Product names and markings noted herein may be trademarks of their respective owners.

PRECISION STRAIN GAGES

General Information	6
Designation System	8
Gage Series Selection Chart	9
Selection Criteria	11
Strain Gage Dimensions	13

LINEAR PATTERNS (GENERAL-USE)

015DJ	16
015LW	17
015UW	18
031CE	19
031CF	20
031DE	21
031EC	22
032UW	23
060PB	24
062AK	25
062AP	26
062AQ	27
062DN	28
062ED	29
062EN	30
062LW	31
062UW	32
125AC	33
125AD	34
125BB	35
125BT	36
125BZ	37
125LW	38
125PC	39
125UN	40
125UW	41
187UW	42
250AE	43
250BF	44
250BG	45
250BK	46
250LW	47
250PD	48
250UN	49
250UW	50
375UW	51
500BH	52
500UW	53
10CBE	54
20CBW	55
20CLW	56
Other Linear Patterns	57

TEE ROSETTES (GENERAL-USE)

050TG	66
062LT	67
062TJ	68
062TT	69
062TZ	70
062UT	71
062WT	72
120WT	73
125LT	74
125TG	75
125TM	76
125UT	77
125WT	78

250TM.....	79
250UT	80
Other Tee Rosette Patterns	81
RECTANGULAR ROSETTES (GENERAL-USE)	
031RB	86
031WW	87
G1350	88
060WR	89
062LR	90
062UR.....	91
062WW	92
120WR	93
125LR	94
125RA.....	95
125UR.....	96
125WW	97
250LR	98
250UR.....	99
250WW	100
Other Rectangular Rosette Patterns	101
DELTA ROSETTES (GENERAL-USE)	
Other Delta Rosette Patterns.....	104
SHEAR/TORQUE ROSETTES (GENERAL-USE)	
062DY	106
062LV	107
062TH	108
062TV.....	109
062UV	110
125TK	111
187UV	112
250US.....	113
Other Shear/Torque Patterns.....	114
SR-4® STRAIN GAGES	
FAE Series	118
SPECIAL USE SENSORS	
Residual Stress Patterns	120
Magnetic Field Patterns.....	121
Standard Weldable Patterns.....	122
Sealed Weldable Patterns	124
High-Temperature Weldable Patterns.....	126
High-Temperature Patterns	128
Shear Modulus Testing Patterns.....	132
Concrete Embedment Gages	133
Temperature Sensors and LST Networks.....	134
Manganin Patterns	137
Crack Detection Patterns	139
Crack Propagation Patterns	141
Linear Displacement Sensors.....	143
Cable-Extension Displacement Sensors	145
STRAIN GAGE ACCESSORIES AND INSTRUMENTS	
Strain Gage Installation	148
Instrument Selection.....	151
TECHNICAL DATA FOR GENERAL-USE STRAIN GAGES	
Gage Series—Stress Analysis Gages.....	154
Optional Features—Stress Analysis Gages.....	162



General Information	6
Designation System	8
Selection Chart	9
Selection Criteria	11
Strain Gage Dimensions	13

Precision Strain Gages

Stress Analysis Strain Gages

HOW TO USE THE LISTINGS

General-use Micro-Measurements strain gages are listed in groups according to grid geometry:

- Linear patterns
- Tee rosettes
- Rectangular rosettes
- Delta rosettes
- Shear/torque patterns

For each of these grid geometries, those patterns most commonly used by our customers are listed first with complete specifications. Additional listings with partial specifications follow for the less commonly used patterns. In both listings, the gage patterns appear in alpha-numeric order, increasing from the shortest grid lengths to the longest.

Some seldom, if ever, ordered patterns listed in previous versions of this databook have been omitted. We will, of course, continue to make these patterns available upon request for customers presently using them. For details, contact the Applications Engineering Department at the Micro-Measurements sales office nearest you.

Separate listings are provided for special-use strain gages and sensors:

- Residual stress
- Magnetic fields
- Weldable gages
- High temperature gages
- Manganin pressure gages
- Shear modulus gages
- Embedment gages
- Temperature sensors
- Crack detection sensors
- Crack propagation sensors
- Displacement sensors

ADVANCED SENSORS GAGES

Customers whose application requires gages for the manufacture of precision commercial transducers are strongly encouraged to contact our Applications Engineering Department. They can provide assistance in the selection of the proper Advanced Sensor for your particular application.

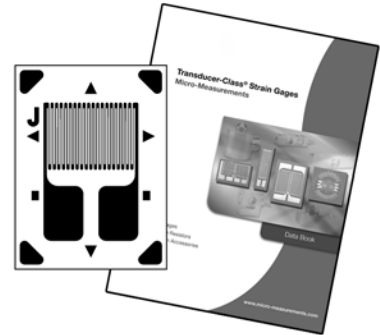

CUSTOM GAGES

Micro-Measurements maintains the most extensive variety of catalog strain gages available today. Whether for stress analysis, transducer manufacturing, or special-purpose applications, we have not only a wide selection, but also a large and varied inventory that is readily available for immediate delivery.

However, many of our customers have applications requiring gages that are manufactured to their individual specifications. While we believe our wide variety of standard catalog gages will satisfy most requirements, we recognize the need for custom products and are committed to serving it well.

To request a quotation for a custom gage, please contact our Applications Engineering Department.

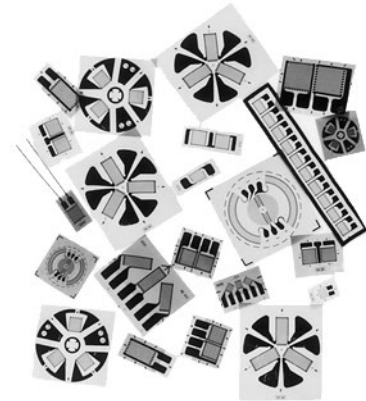

Stress Analysis Strain Gages

APPLICATIONS SUPPORT

Micro-Measurements maintains an experienced and highly trained applications engineering staff. Our Applications Engineers are as close as your telephone, and we urge you to call them for recommendations in strain gage selection to satisfy your particular test requirements.



TECHNICAL INFORMATION

Detailed technical information about the selection and application of strain gages can be found in the special series of Tech Notes, Tech Tips, and Instruction Bulletins on strain gage technology. Thorough familiarity with these publications will help ensure consistent success in the use of Micro-Measurements strain gages.

We also offer our customers an extensive assortment of additional product and technical literature, available in the strain gage technology knowledge base on our website at:

<http://www.vishaypg.com/micro-measurements/stress-analysis-strain-gages/knowledge-base-list/>.

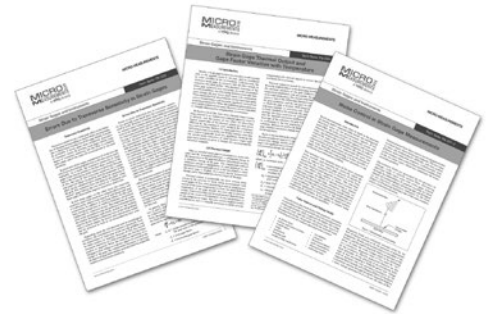

STRAIN GAGE ACCESSORIES AND INSTRUMENTATION

In addition to an extensive selection of strain gages, Micro-Measurements offers a complete range of complementary products. Strain gage accessories include surface preparation materials, adhesives, installation tools, protective coatings, leadwire, and a host of other application tools, hardware, and supplies. Instruments range from portable, digital strain indicators, to sophisticated computer-controlled systems for the acquisition, storage, and reduction of test data. Both static and dynamic measuring instruments are available—each uniquely designed to provide stable, accurate, and reliable strain measurement.

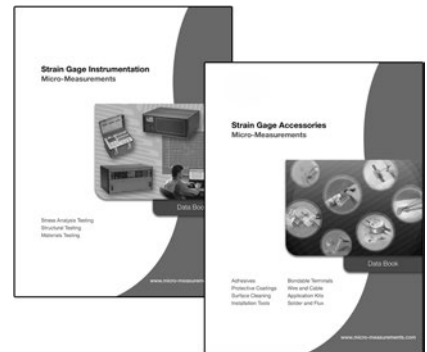

TRAINING PROGRAMS

Training customers in the proper use of strain measurement techniques is an essential part of the Micro-Measurements philosophy. In support of this principle, Micro-Measurements conducts an extensive series of regularly scheduled technical seminars, workshops, and short courses. Course instructors are recognized authorities in their field. Training sessions are conducted at our facilities in the United States and Europe, as well as at hotels and educational institutions around the world. For schedules, go to:

<http://www.vishaypg.com/micro-measurements/training-programs/>



Stress Analysis Strain Gages

The Strain Gage Designation System described below applies to Micro-Measurements General-Use Strain Gages.

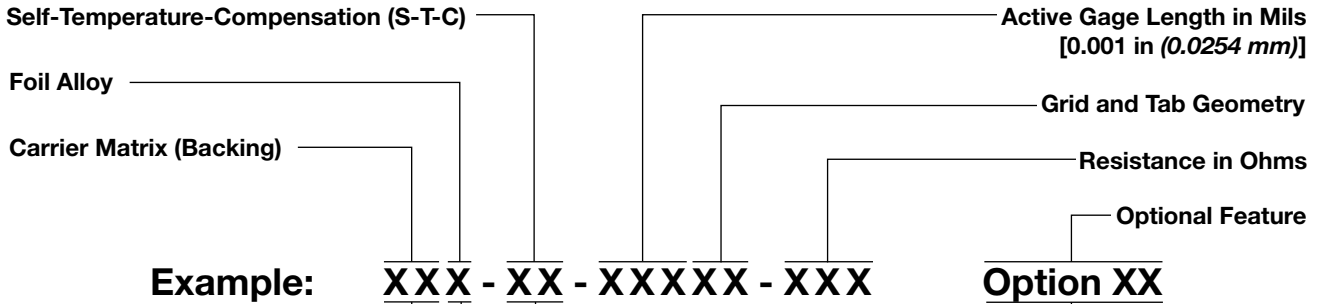

<p>E: Open-faced cast polyimide backing.</p> <p>CE: Thin, flexible gages with a cast polyimide backing and encapsulation featuring large, rugged, copper-coated solder tabs. This construction provides optimum capability for direct leadwire attachment.</p> <p>L2: Thin, laminated, polyimide-film backing featuring encapsulated grids with preattached leadwire ribbons.</p> <p>C2: Thin, laminated, polyimide-film backing featuring encapsulated grids with leadwire cables.</p> <p>W: Fully encapsulated, glass-fiber-reinforced epoxy phenolic resin. High endurance leadwires.</p> <p>N2: The 'N2' matrix provides an open faced gage on a thin, high-performance laminated polyimide film backing.</p> <p>S2: Gage grid and solder tabs fully encapsulated in a thin, flexible, laminated polyimide film. Provided with large [0.030 in (0.75 mm)] solder pads for ease of leadwire attachment.</p> <p>S: Full encapsulation identical to the W matrix, but with solder dot connections instead of leadwires.</p>	<p>A: Constantan alloy in self-temperature-compensated form.</p> <p>P: Annealed Constantan.</p> <p>D: Isoelastic alloy.</p> <p>K: Nickel-chromium alloy (similar to Karma).</p>	<p>The S-T-C number is the approximate thermal expansion coefficient in ppm/°F of the structural material on which the gage is to be used. The following S-T-C numbers are available:</p> <p>A: 00, 03, 05, 06, 09, 13, 15, 18, 30, 50</p> <p>P: 08, 40</p> <p>K: 00, 03, 05, 06, 09, 13, 15</p> <p>D: Not available in self-temperature-compensated form. 'DY' is used instead.</p>	<p>W: Integral printed circuit terminal, polyimide encapsulation.</p> <p>E: Polyimide encapsulation, leaving a portion of solder tab exposed.</p> <p>SE: Solder dots plus polyimide encapsulation.</p> <p>L: Preattached, soft, formable copper leads.</p> <p>LE: Leads plus polyimide encapsulation.</p> <p>P: Preattached leadwire cables and encapsulation.</p> <p>P2: Preattached leadwire cables for CEA-Series gages.</p>
--	---	--	--

Standard Stress Analysis Strain Gages

GAGE SERIES	DESCRIPTION AND PRIMARY APPLIATION	TEMPERATURE RANGE	STRAIN RANGE	FATIGUE LIFE	
				STRAIN LEVEL IN $\mu\epsilon$	NUMBER OF CYCLES
EA	Constantan foil in combination with a tough, flexible, polyimide backing. Wide range of options available. Primarily intended for general-purpose static and dynamic stress analysis. Not recommended for highest accuracy transducers.	Normal: -100° to +350°F (-75° to +175°C) Special or short term: -320° to +400°F (-195° to +205°C)	±3% for gage lengths under 1/8 in (3.2 mm) ±5% for 1/8 in and over	±1800 ±1500 ±1200	10 ⁵ 10 ⁶ 10 ⁸
CEA	Universal general-purpose strain gages. Constantan grid completely encapsulated in polyimide, with large, rugged copper-coated tabs. Primarily used for general-purpose static and dynamic stress analysis.	Normal: -100° to +350°F (-75° to +175°C) Stacked rosettes limited to +150°F (+65°C)	±3% for gage lengths under 1/8 in (3.2 mm) ±5% for 1/8 in and over	±1500 ±1500	10 ⁵ 10 ^{6*}
				*Fatigue life improved using low-modulus solder.	
C2A	General-purpose stress analysis strain gages. Supplied with preattached cables for direct connection to instrumentation.	-60° to +180°F (-50° to +80°C)	±3%	±1700 ±1500	10 ⁵ 10 ⁶
L2A	General-purpose stress analysis strain gages. Supplied with preattached leadwire ribbons.	-100° to +250°F (-75° to +120°C)	±3%	±1700 ±1500	10 ⁵ 10 ⁶
N2A	Open-faced constantan foil gages with a thin, laminated, polyimide-film backing. Primarily recommended for use in precision transducers, the N2A Series is characterized by low and repeatable creep performance. Also recommended for stress analysis applications employing large gage patterns, where the especially flat matrix eases gage installation.	Normal static transducer service: -100° to +200°F (-75° to +95°C)	±3%	±1700 ±1500	10 ⁶ 10 ⁷
WA	Fully encapsulated constantan gages with high-endurance leadwires. Useful over wider temperature ranges and in more extreme environments than EA Series. Option W available on some patterns, but restricts fatigue life to some extent.	Normal: -100° to +400°F (-75° to +205°C) Special or short term: -320° to +500°F (-195° to +260°C)	±2%	±2000 ±1800 ±1500	10 ⁵ 10 ⁶ 10 ⁷
SA	Fully encapsulated constantan gages with solder dots. Same matrix as WA Series. Same uses as WA Series but derated somewhat in maximum temperature and operating environment because of solder dots.	Normal: -100° to +400°F (-75° to +205°C) Special or short-term: -320° to +450°F (-195° to +230°C)	±2%	±1800 ±1500	10 ⁶ 10 ⁷
EP	Specially annealed constantan foil with tough, high-elongation polyimide backing. Used primarily for measurements of large post-yield strains. Available with Options E, L, and LE (may restrict elongation capability).	-100° to +400°F (-75° to +205°C)	±10% for gage lengths under 1/8 in (3.2 mm) ±20% for 1/8 in and over	±1000	10 ⁴
				EP gages show zero shift under high-cyclic strains.	
ED	Isoelastic foil in combination with tough, flexible polyimide film. High gage factor and extended fatigue life excellent for dynamic measurements. Not normally used in static measurements due to very high thermal-output characteristics.	Dynamic: -320° to +400°F (-195° to +205°C)	±2% Nonlinear at strain levels over ±0.5%	±2500 ±2200	10 ⁶ 10 ⁷

Standard Stress Analysis Strain Gages

GAGE SERIES	DESCRIPTION AND PRIMARY APPLIATION	TEMPERATURE RANGE	STRAIN RANGE	FATIGUE LIFE	
				STRAIN LEVEL IN $\mu\epsilon$	NUMBER OF CYCLES
WD	Fully encapsulated isoelastic gages with high-endurance leadwires. Used in wide-range dynamic strain measurement applications in severe environments.	Dynamic: -320° to +500°F (-195° to +260°C)	±1.5% Nonlinear at strain levels over ±0.5%	±3000 ±2500 ±2200	10 ⁵ 10 ⁷ 10 ⁸
SD	Equivalent to WD Series, but with solder dots instead of leadwires.	Dynamic: -320° to +400°F (-195° to +205°C)	±1.5% Nonlinear at strain levels over ±0.5%	±2500 ±2200	10 ⁶ 10 ⁷
EK	K-alloy foil in combination with a tough, flexible polyimide backing. Primarily used where a combination of higher grid resistances, stability at elevated temperature, and greatest backing flexibility are required. Supplied with Option DP.	Normal: -320° to +350°F (-195° to +175°C) Special or short term: -452° to +400°F (-269° to +205°C)	±1.5%	±1800	10 ⁷
WK	Fully encapsulated K-alloy gages with high endurance leadwires. Widest temperature range and most extreme environmental capability of any general-purpose gage when self-temperature compensation is required. Option W available on some patterns, but restricts both fatigue life and maximum operating temperature.	Normal: -452° to +550°F (-269° to +290°C) Special or short term: -452° to +750°F (-269° to +400°C)	±1.5%	±2200 ±2000	10 ⁶ 10 ⁷
SK	Fully encapsulated K-alloy gages with solder dots. Same uses as WK Series, but derated in maximum temperature and operating environment because of solder dots.	Normal: -452° to +450°F (-269° to +230°C) Special or short term: -452° to +500°F (-269° to +260°C)	±1.5%	±2200 ±2000	10 ⁶ 10 ⁷
S2K	K-alloy foil laminated to 0.001 in (0.025 mm) thick, high-performance polyimide backing, with a laminated polyimide overlay fully encapsulating the grid and solder tabs. Provided with large solder dots for ease of leadwire attachment.	Normal: -100° to +250°F (-75° to +120°C) Special or short term: -300° to +300°F (-185° to +150°C)	±1.5%	±1800 ±1500	10 ⁶ 10 ⁷

Notes:

The performance data given here are nominal, and apply primarily to gages of 0.125-in (3-mm) gage length or larger. Refer to Gage Series/Optional Feature data sheet for more detailed description and performance specifications.

Stress Analysis Strain Gages

GAGE SELECTION

Many factors, such as test duration, strain range required, and operating temperature, must be considered in selecting the best strain gage/adhesive combination for a given test profile. These factors and others are addressed in Tech Note TN-505, "Strain Gage Selection—Criteria, Procedures, Recommendations."

SELF-TEMPERATURE COMPENSATION (S-T-C)

All gages with XX as the second code group in the gage designation are self-temperature-compensated for use on structural materials with specific thermal expansion

coefficients. The table below lists S-T-C numbers and test specimen materials to which gages are thermally matched.

When ordering, replace the XX code group with the desired S-T-C number, which is the approximate thermal expansion coefficient of the structural material in ppm/°F. The Gage Designation System lists the available S-T-C numbers for specific grid alloys. The 06 and 13 values, available in A and K alloys, are most common and more likely to be in stock. When not otherwise specified, the 06 compensation is shipped.

GAGE RESISTANCE

Micro-Measurements strain gages are available in various resistance values that range from 30 to 5000 ohms.

Strain gages with resistances of 120 and 350 ohms are commonly used in experimental stress analysis testing. For the majority of applications, 120-ohm gages are usually suitable; 350-ohm gages would be preferred to reduce heat generation (for the same applied voltage across the gage), to decrease leadwire effects, or to improve signal-to-noise ratios in the gage circuit. Higher resistance gages are typically used in transducer applications and on composite materials.

GAGE FACTOR

Gage Factor (GF) is the measure of sensitivity, or *output*, produced by a resistance strain gage. Gage factor is determined through calibration of the specific gage type, and is the ratio between $\Delta R/R_0$ and $\Delta L/L$ (strain), where R_0 is the initial unstrained resistance of the gage. It is affected somewhat by pattern size, geometry, S-T-C number, and temperature. Each gage package is supplied with the GF as well as its tolerance and temperature sensitivity. Nominal gage factors for various alloys are: A = 2.05; K = 2.1; D = 3.2; P = 2.00.

TRANSVERSE SENSITIVITY

All gages are sensitive, to some degree, to strains transverse to the grid direction. The transverse sensitivity factor (K_t) is given with the engineering data supplied with all gage types for which the data is relevant.

STRAIN GAGE ADHESIVE SELECTION

When selecting a strain gage, it is most important to consider the adhesive that will be used to bond the gage, since the adhesive becomes part of the gage system and correspondingly affects the performance of the gage. However, when the interaction of test characteristics becomes too complex for selecting the gage/adhesive combination in a straight forward manner, contact our Applications Engineering Department for recommendations.

S-T-C NO.	EXPANSION COEFFICIENTS**		COMMON MATERIAL
	per °F	per °C	
00	0.8	1.4	Invar, Fe-Ni alloy Quartz, fused Titanium Silicate*, polycrystalline
	0.3	0.5	
	0.017	0.03	
03	3.0	5.4	Alumina, fired Molybdenum*, pure Tungsten, pure Zirconium, pure
	2.7	4.9	
	2.4	4.3	
	3.1	5.6	
05	5.1	9.2	Glass, Soda-Lime-Silica Stainless Steel, Ferritic (410) Titanium, pure Titanium Alloy, 6Al-4V*
	5.5	9.9	
	4.8	8.6	
	4.9	8.8	
06	6.4	11.5	Beryllium, pure Cast Iron, grey Inconel, Ni-Cr-Fe alloy Inconel X, Ni-Cr-Fe alloy Monel, Ni-Cu alloy Nickel-A, Cu-Zn-Ni alloy Steel alloy, 4340 Steel, Carbon, 1008, 1018* Steel, Stainless, Age Hardenable (17-4PH) Steel, Stainless, Age Hardenable (17-7PH) Steel, Stainless, Age Hardenable (PH15-7Mo)
	6.0	10.8	
	7.0	12.6	
	6.7	12.1	
	7.5	13.5	
	6.6	11.9	
	6.3	11.3	
	6.7	12.1	
	6.0	10.8	
	5.7	10.3	
5.0	9.0		
09	9.3	16.7	Beryllium Copper, Cu 75, BE 25 Bronze, Phosphor, Cu 90, Sn 10 Copper, pure Steel, Stainless, Austenitic (304*) Steel, Stainless, Austenitic (310) Steel, Stainless, Austenitic (316)
	10.2	18.4	
	9.2	16.5	
	9.6	17.3	
	8.0	14.4	
	8.9	16.0	
13	12.9	23.2	Aluminum Alloy, 2024-T4*, 7075 T6 Brass, Cartridge, Cu 70-Zn 30 Tin, pure
	11.1	20.0	
	13.0	23.4	
15	14.5	26.1	Magnesium Alloy*, AZ-318

* Indicates type of material used in determining thermal output curves supplied with Micro-Measurements strain gages.

** Nominal values at or near room temperature for temperature coefficient of expansion values.

Stress Analysis Strain Gages

CUSTOM GAGES

Unusual applications occasionally require a strain gage which is neither listed in the catalog nor available by adding special optional features. Often a custom product can be designed to fit such needs.

Careful consideration is given to the backing, foil, S-T-C, gage length, pattern, resistance and resistance tolerance, operating temperature range, test duration, maximum strain, cyclic endurance, leads, encapsulation, and trim so that the custom gage is designed to properly meet the

user's needs. Examples of custom gages include such features as unusual patterns, special trim dimensions, and nonstandard lead materials or length.

A special part number is normally assigned to each custom gage. Doing so ensures that the correct gage is produced each time it is ordered. A set-up charge and a minimum order will normally apply. For further information contact our Applications Engineering Department.

Strain Gage Dimensions

Gage length is an important consideration in strain gage selection, and is usually the first parameter to be defined.

Dimensions listed for gage length (as measured inside the grid endloops) and grid width refer to active grid dimensions. Overall length and width refer to the actual foil pattern, not including alignment marks or backing.

The matrix size represents the approximate dimensions of the backing/matrix of the gage as shipped. Matrix dimensions are nominal, with a usual tolerance of ± 0.015 in (± 0.4 mm). If the gages are encapsulated, the matrix may be smaller by as much as 0.01 in (0.25 mm). Most patterns also include trim marks, and, for use in a restricted area, the backing/matrix may be field-trimmed on all sides to within 0.01 in (0.25 mm) of the foil pattern without affecting gage performance.

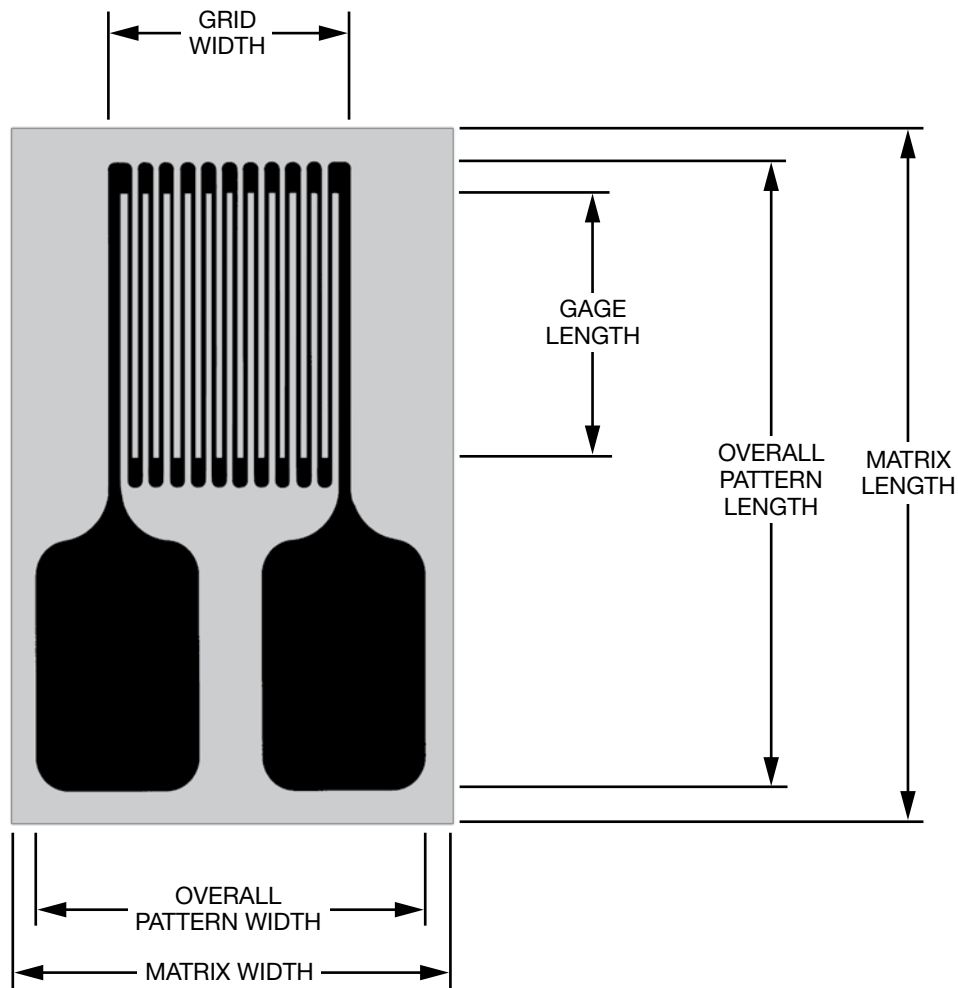

Linear Patterns (General-Use)



FEATURES

- Gage patterns designed for measuring strain in a single direction
- Single-grid and parallel dual-grid patterns
- Gage lengths from 0.008" (0.20 mm) to 4.000" (101.6 mm)

PATTERNS

015DJ	16
015LW	17
015UW	18
031CE	19
031CF	20
031DE	21
031EC	22
032UW	23
060PB	24
062AK	25
062AP	26
062AQ	27
062DN	28
062ED	29
062EN	30
062LW	31
062UW	32
125AC	33
125AD	34
125BB	35
125BT	36
125BZ	37
125LW	38
125PC	39
125UN	40
125UW	41
187UW	42
250AE	43
250BF	44
250BG	45
250BK	46
250LW	47
250PD	48
250UN	49
250UW	50
375UW	51
500BH	52
500UW	53
10CBE	54
20CBW	55
20CLW	56
Other Linear Patterns	57

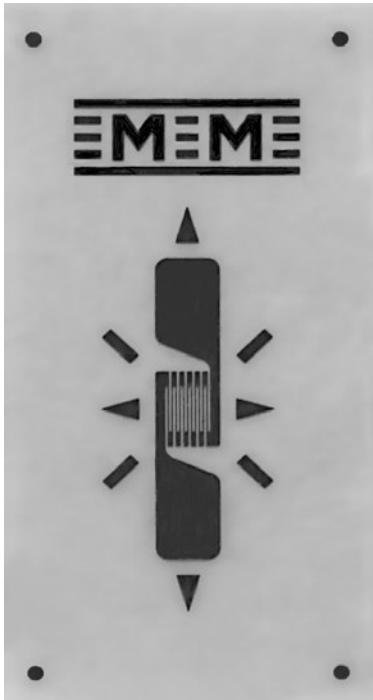
General Purpose Strain Gages – Linear Pattern

GAGE PATTERN DATA							
	GAGE DESIGNATION See Note 1, 3		RESISTANCE (OHMS) See Note 2	OPTIONS AVAILABLE See Note 3			
	EA-XX-015DJ-120 EP-08-015DJ-120 SA-XX-015DJ-120 SK-XX-015DJ-120		120 ± 0.3% 120 ± 0.3% 120 ± 0.6% 120 ± 0.6%	L, LE			
 <p>actual size</p>							
DESCRIPTION Micro-miniature pattern with tab at each end of grid. See also 015EH pattern.							
GAGE DIMENSIONS		Legend ES = Each Section CP = Complete Pattern S = Section (S1 = Section 1) M = Matrix					
				<table border="1"> <tr> <td>inch</td> </tr> <tr> <td>millimeter</td> </tr> </table>		inch	millimeter
inch							
millimeter							
Gage Length	Overall Length	Grid Width	Overall Width	Matrix Length	Matrix Width		
0.015	0.100	0.020	0.020	0.23	0.12		
0.38	2.54	0.51	0.51	5.8	3.0		



GAGE SERIES DATA — See Gage Series datasheet for complete specifications			
Series	Description	Strain Range	Temperature Range
EA	Constantan foil in combination with a tough, flexible, polyimide backing.	±3%	-100° to +350°F (-75° to +175°C)
EP	Annealed constantan foil with tough, high-elongation polyimide backing.	±10%	-100° to +400°F (-75° to +205°C)
SA	Fully encapsulated constantan gages with solder dots.	±2%	-100° to +400°F (-75° to +205°C)
SK	Fully encapsulated K-alloy gages with solder dots.	±1.5%	-452° to +450°F (-269° to +230°C)



Note 1: Insert desired S-T-C number in spaces marked XX.

Note 2: Tolerance is increased when Option W, E, SE, LE, or P is specified.

Note 3: Products with designations and options shown in **bold** are not RoHS compliant.



General Purpose Strain Gages – Linear Pattern

GAGE PATTERN DATA					
 <p style="text-align: center;">actual size</p>			GAGE DESIGNATION See Note 1	RESISTANCE (OHMS)	OPTIONS AVAILABLE
			L2A-XX-015LW-120 C2A-XX-015LW-120	120 ± 0.6% 120 ± 0.6%	
DESCRIPTION Widely used general-purpose gage.					
GAGE DIMENSIONS		Legend ES = Each Section CP = Complete Pattern S = Section (S1 = Section 1) M = Matrix			<input type="checkbox"/> inch <input type="checkbox"/> millimeter
Gage Length	Overall Length	Grid Width	Overall Width	Matrix Length	Matrix Width
0.015	0.052	0.020	0.034	0.075	0.054
0.38	1.32	0.50	0.86	1.90	1.37

GAGE SERIES DATA — See Gage Series datasheet for complete specifications			
Series	Description	Strain Range	Temperature Range
C2A	Encapsulated constantan gages with preattached ready-to-use cables.	±3%	-60° to +180°F (-50° to +80°C)
<div style="display: flex; justify-content: space-around; align-items: center;"> <div style="text-align: center;">  <p>Example of an L2A Construction</p> </div> <div style="text-align: center;">  <p>Example of an C2A Construction</p> </div> </div>			

Note 1: Insert desired S-T-C number in spaces marked XX.

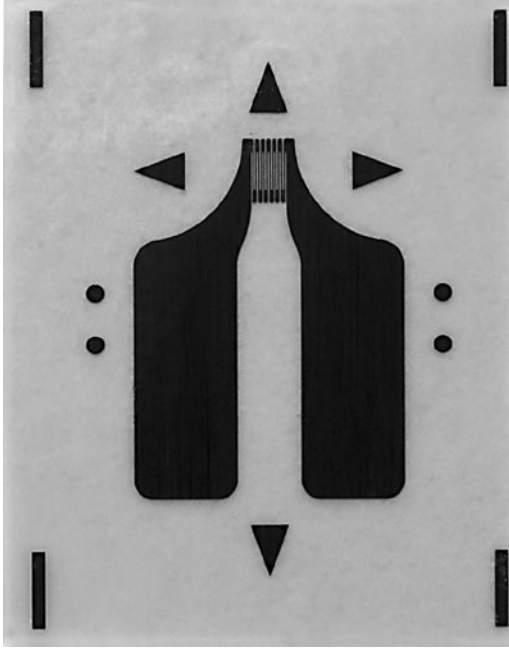
General Purpose Strain Gages – Linear Pattern

GAGE PATTERN DATA					
 <p style="text-align: center;">  actual size </p>			GAGE DESIGNATION See Note 1	RESISTANCE (OHMS) 120 ± 0.3%	OPTIONS AVAILABLE
			CEA-XX-015UW-120		
			DESCRIPTION Micro-miniature pattern. Exposed solder tab area is 0.06 x 0.04 (1.5 x 1.0 mm). See also 015CK pattern		
GAGE DIMENSIONS		Legend ES = Each Section CP = Complete Pattern S = Section (S1 = Section 1) M = Matrix			<input type="checkbox"/> inch <input checked="" type="checkbox"/> millimeter
Gage Length	Overall Length	Grid Width	Overall Width	Matrix Length	Matrix Width
0.015	0.140	0.020	0.105	0.24	0.18
0.38	3.56	0.51	2.67	6.1	4.6

GAGE SERIES DATA — See Gage Series datasheet for complete specifications			
Series	Description	Strain Range	Temperature Range
CEA	Universal general-purpose strain gages.	±3%	-100° to +350°F (-75° to +175°C)

Note 1: Insert desired S-T-C number in spaces marked XX.

General Purpose Strain Gages—Linear Pattern

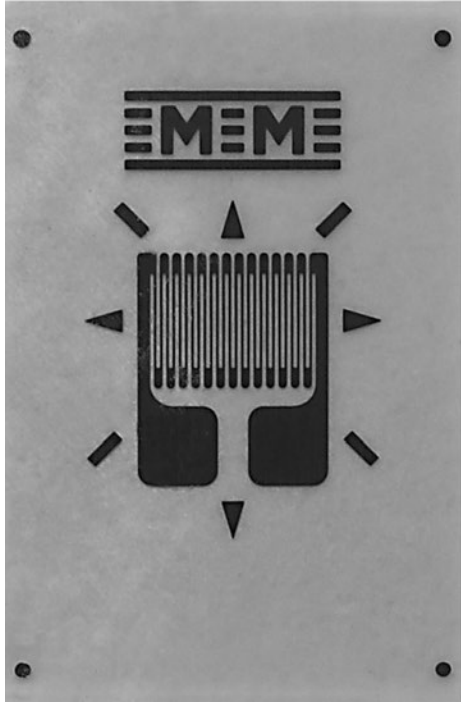
GAGE PATTERN DATA					
 <p>actual size</p>		GAGE DESIGNATION See Note 1, 3	RESISTANCE (OHMS) See Note 2	OPTIONS AVAILABLE See Note 3	
		EA-XX-031CE-350 WA-XX-031CE-350 EP-XX-031CE-350 SA-XX-031CE-350	350 ± 0.2% 350 ± 0.4% 350 ± 0.2% 350 ± 0.4%	W, E, L, LE, P	
DESCRIPTION General-purpose high-resistance miniature gage.					
GAGE DIMENSIONS		Legend ES = Each Section CP = Complete Pattern S = Section (S1 = Section 1) M = Matrix			
				inch	
				millimeter	
Gage Length	Overall Length	Grid Width	Overall Width	Matrix Length	Matrix Width
0.031	0.076	0.062	0.062	0.23	0.16
0.79	1.93	1.57	1.57	5.8	4.1

GAGE SERIES DATA — See Gage Series datasheet for complete specifications			
Series	Description	Strain Range	Temperature Range
EA	Constantan foil in combination with a tough, flexible, polyimide backing.	±3%	-100° to +350°F (-75° to +175°C)
WA	Fully encapsulated constantan gages with high-endurance leadwires.	±2%	-100° to +400°F (-75° to +205°C)
EP	Annealed constantan foil with tough, high-elongation polyimide backing.	±10%	-100° to +400°F (-75° to +205°C)
SA	Fully encapsulated constantan gages with solder dots.	±2%	-100° to +400°F (-75° to +205°C)

Note 1: Insert desired S-T-C number in spaces marked XX.

Note 2: Tolerance is increased when Option W, E, SE, LE, or P is specified.

Note 3: Products with designations and options shown in **bold** are not RoHS compliant.

General Purpose Strain Gages – Linear Pattern

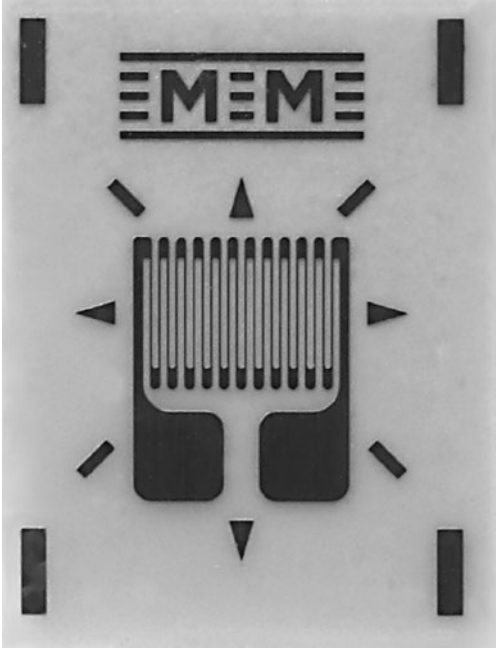
GAGE PATTERN DATA					
 <p>actual size</p>		GAGE DESIGNATION See Note 1, 3	RESISTANCE (OHMS) See Note 2	OPTIONS AVAILABLE See Note 3	
		EA-XX-031CF-120 ED-DY-031CF-350 WA-XX-031CF-120 WK-XX-031CF-350 EP-08-031CF-120 SA-XX-031CF-120 SK-XX-031CF-120 SK-XX-031CF-350 SD-DY-031CF-350	120 ± 0.2% 350 ± 0.4% 120 ± 0.4% 350 ± 0.4% 120 ± 0.2% 120 ± 0.4% 120 ± 0.4% 350 ± 0.4% 350 ± 0.8%	W, E, L, LE, P E, L*, LE*	
DESCRIPTION General-purpose miniature gage. Similar to 031CE pattern except for resistance. See also 032UW pattern.					
GAGE DIMENSIONS		Legend ES = Each Section CP = Complete Pattern S = Section (S1 = Section 1) M = Matrix			
					inch millimeter
Gage Length	Overall Length	Grid Width	Overall Width	Matrix Length	Matrix Width
0.031	0.076	0.062	0.062	0.19	0.14
0.79	1.93	1.57	1.57	4.8	3.5

GAGE SERIES DATA — See Gage Series datasheet for complete specifications			
Series	Description	Strain Range	Temperature Range
EA	Constantan foil in combination with a tough, flexible, polyimide backing.	±3%	-100° to +350°F (-75° to +175°C)
ED	Isoelastic foil in combination with tough, flexible polyimide film.	±2%	-320° to +400°F (-195° to +205°C)
WA	Fully encapsulated constantan gages with high-endurance leadwires.	±2%	-100° to +400°F (-75° to +205°C)
WK	Fully encapsulated K-alloy gages with high-endurance leadwires.	±1.5%	-452° to +550°F (-269° to +290°C)
EP	Annealed constantan foil with tough, high-elongation polyimide backing.	±10%	-100° to +400°F (-75° to +205°C)
SA	Fully encapsulated constantan gages with solder dots.	±2%	-100° to +400°F (-75° to +205°C)
SK	Fully encapsulated K-alloy gages with solder dots.	±1.5%	-452° to +450°F (-269° to +230°C)
SD	Equivalent to WD Series, but with solder dots instead of leadwires.	±1.5%	-320° to +400°F (-195° to +205°C)

Note 1: Insert desired S-T-C number in spaces marked XX.

Note 2: Tolerance is increased when Option W, E, SE, LE, or P is specified.

Note 3: Products with designations and options shown in **bold** are not RoHS compliant.

*Options available but not normally recommended. See Optional Features data sheet for details.

General Purpose Strain Gages – Linear Pattern

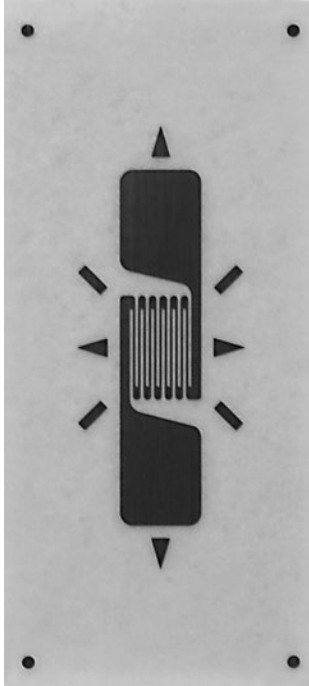
GAGE PATTERN DATA							
		GAGE DESIGNATION See Note 1, 3		RESISTANCE (OHMS) See Note 2	OPTIONS AVAILABLE See Note 3		
		EA-XX-031DE-120 EA-XX-031DE-350 ED-DY-031DE-350 WA-XX-031DE-120 WA-XX-031DE-350 WK-XX-031DE-350 EP-XX-031DE-120 SA-XX-031DE-350 SA-XX-031DE-350 SK-XX-031DE-120 SK-XX-031DE-350 SD-DY-031DE-350		120 ± 0.2% 350 ± 0.2% 350 ± 0.4% 120 ± 0.4% 350 ± 0.4% 350 ± 0.4% 120 ± 0.2% 350 ± 0.4% 350 ± 0.4% 120 ± 0.4% 350 ± 0.4% 350 ± 0.8%	E, SE , L, LE E, SE , L, LE E, L*, LE*		
		DESCRIPTION General-purpose miniature gage.					
GAGE DIMENSIONS		Legend ES = Each Section CP = Complete Pattern S = Section (S1 = Section 1) M = Matrix					
		<table border="1"> <tr> <td>inch</td> </tr> <tr> <td>millimeter</td> </tr> </table>				inch	millimeter
inch							
millimeter							
Gage Length	Overall Length	Grid Width	Overall Width	Matrix Length	Matrix Width		
0.031	0.140	0.032	0.032	0.27	0.12		
0.79	3.56	0.81	0.81	6.9	3.0		

GAGE SERIES DATA — See Gage Series datasheet for complete specifications			
Series	Description	Strain Range	Temperature Range
EA	Constantan foil in combination with a tough, flexible, polyimide backing.	±3%	-100° to +350°F (-75° to +175°C)
ED	Isoelastic foil in combination with tough, flexible polyimide film.	±2%	-320° to +400°F (-195° to +205°C)
WA	Fully encapsulated constantan gages with high-endurance leadwires.	±2%	-100° to +400°F (-75° to +205°C)
WK	Fully encapsulated K-alloy gages with high-endurance leadwires.	±1.5%	-452° to +550°F (-269° to +290°C)
EP	Annealed constantan foil with tough, high-elongation polyimide backing.	±10%	-100° to +400°F (-75° to +205°C)
SA	Fully encapsulated constantan gages with solder dots.	±2%	-100° to +400°F (-75° to +205°C)
SK	Fully encapsulated K-alloy gages with solder dots.	±1.5%	-452° to +450°F (-269° to +230°C)
SD	Equivalent to WD Series, but with solder dots instead of leadwires.	±1.5%	-320° to +400°F (-195° to +205°C)



Note 1: Insert desired S-T-C number in spaces marked XX.

Note 2: Tolerance is increased when Option W, E, SE, LE, or P is specified.

Note 3: Products with designations and options shown in **bold** are not RoHS compliant.

*Options available but not normally recommended. See Optional Features data sheet for details.

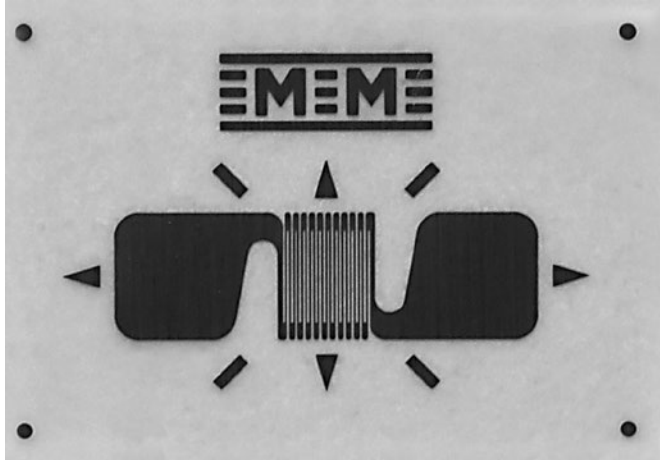
General Purpose Strain Gages—Linear Pattern

GAGE PATTERN DATA						
		GAGE DESIGNATION See Note 1, 3	RESISTANCE (OHMS) See Note 2	OPTIONS AVAILABLE See Note 3		
		EA-XX-031EC-120 EA-XX-031EC-350 ED-DY-031EC-350 WA-XX-031EC-120 WA-XX-031EC-350 WK-XX-031EC-350 EP-08-031EC-120 SA-XX-031EC-120 SA-XX-031EC-350 SK-XX-031EC-120 SK-XX-031EC-350 SD-DY-031EC-350	120 ± 0.2% 350 ± 0.2% 350 ± 0.4% 120 ± 0.4% 350 ± 0.4% 350 ± 0.4% 120 ± 0.2% 120 ± 0.4% 350 ± 0.4% 120 ± 0.4% 350 ± 0.4% 350 ± 0.8%	E, SE , L, LE E, SE , L, LE E, L*, LE*		
 actual size		DESCRIPTION General-purpose miniature gage. Similar to 031DE pattern but with tab at each side of grid.				
GAGE DIMENSIONS		Legend ES = Each Section S = Section (S1 = Section 1)			CP = Complete Pattern M = Matrix	<input type="checkbox"/> inch <input type="checkbox"/> millimeter
Gage Length	Overall Length	Grid Width	Overall Width	Matrix Length	Matrix Width	
0.031	0.042	0.032	0.140	0.17	0.23	
0.79	1.07	0.81	3.56	4.3	5.8	

GAGE SERIES DATA — See Gage Series datasheet for complete specifications			
Series	Description	Strain Range	Temperature Range
EA	Constantan foil in combination with a tough, flexible, polyimide backing.	±3%	-100° to +350°F (-75° to +175°C)
ED	Isoelastic foil in combination with tough, flexible polyimide film.	±2%	-320° to +400°F (-195° to +205°C)
WA	Fully encapsulated constantan gages with high-endurance leadwires.	±2%	-100° to +400°F (-75° to +205°C)
WK	Fully encapsulated K-alloy gages with high-endurance leadwires.	±1.5%	-452° to +550°F (-269° to +290°C)
EP	Annealed constantan foil with tough, high-elongation polyimide backing.	±10%	-100° to +400°F (-75° to +205°C)
SA	Fully encapsulated constantan gages with solder dots.	±2%	-100° to +400°F (-75° to +205°C)
SK	Fully encapsulated K-alloy gages with solder dots.	±1.5%	-452° to +450°F (-269° to +230°C)
SD	Equivalent to WD Series, but with solder dots instead of leadwires.	±1.5%	-320° to +400°F (-195° to +205°C)

Note 1: Insert desired S-T-C number in spaces marked XX.

Note 2: Tolerance is increased when Option W, E, SE, LE, or P is specified.

Note 3: Products with designations and options shown in **bold** are not RoHS compliant.

*Options available but not normally recommended. See Optional Features data sheet for details.

General Purpose Strain Gages – Linear Pattern

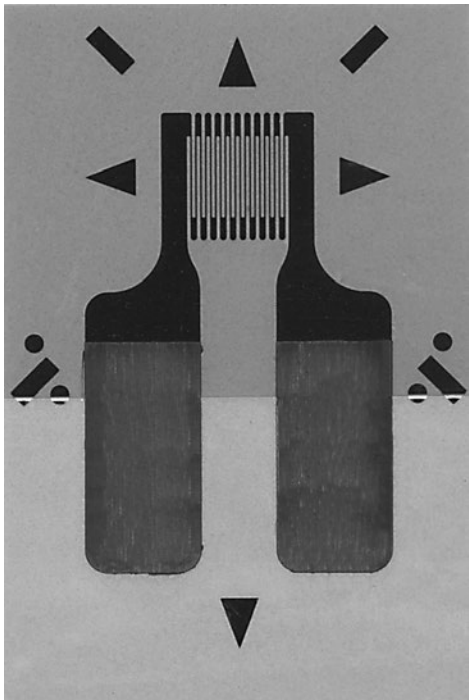
GAGE PATTERN DATA					
 <p>actual size</p>			GAGE DESIGNATION See Note 1	RESISTANCE (OHMS)	OPTIONS AVAILABLE See Note 2
			CEA-XX-032UW-120 CEA-XX-032UW-350	120 ± 0.3% 350 ± 0.3%	P2 P2
DESCRIPTION General-purpose miniature gage. Exposed solder tab area is 0.07 x 0.04 in [1.8 x 1.0 mm].					
GAGE DIMENSIONS		Legend			<input type="checkbox"/> inch <input type="checkbox"/> millimeter
		ES = Each Section CP = Complete Pattern S = Section (S1 = Section 1) M = Matrix			
Gage Length	Overall Length	Grid Width	Overall Width	Matrix Length	Matrix Width
0.032	0.180	0.060	0.120	0.27	0.19
0.81	4.57	1.52	3.05	6.9	4.8

GAGE SERIES DATA — See Gage Series datasheet for complete specifications			
Series	Description	Strain Range	Temperature Range
CEA	Universal general-purpose strain gages.	±3%	-100° to +350°F (-75° to +175°C)

Note 1: Insert desired S-T-C number in spaces marked XX.

Note 2: Products with designations and options shown in **bold** are not RoHS compliant.

General Purpose Strain Gages – Linear Pattern

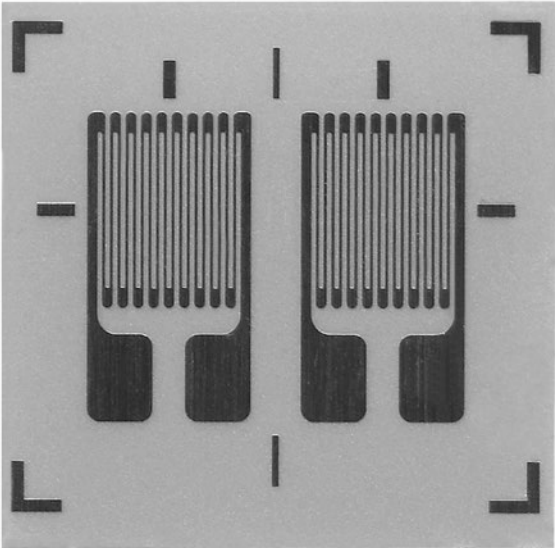
GAGE PATTERN DATA					
 <p style="text-align: center;">actual size</p>		GAGE DESIGNATION See Note 1, 3	RESISTANCE (OHMS) See Note 2	OPTIONS AVAILABLE See Note 3	
		EA-XX-060PB-120 EA-XX-060PB-350 WA-XX-060PB-120 WA-XX-060PB-350 WK-XX-060PB-350 WK-XX-060PB-500 SA-XX-060PB-120 SA-XX-060PB-350 SK-XX-060PB-350 SK-XX-060PB-500	120 ± 0.2% 350 ± 0.2% 120 ± 0.3% 350 ± 0.3% 350 ± 0.3% 500 ± 0.3% 120 ± 0.3% 350 ± 0.3% 350 ± 0.3% 500 ± 0.3%	W, E, L, LE W, E, L, LE W* W* W* W*	
DESCRIPTION Dual pattern for back-to-back bending sections. Longitudinal grid centerlines spaced 0.085 in (2.16 mm) apart.					
GAGE DIMENSIONS		Legend ES = Each Section CP = Complete Pattern S = Section (S1 = Section 1) M = Matrix			
				inch	millimeter
Gage Length	Overall Length	Grid Width	Overall Width	Matrix Length	Matrix Width
0.060 ES	0.120 CP	0.065 ES	0.150 CP	0.18	0.20
1.52 ES	3.05 CP	1.65 ES	3.81 CP	4.6	5.1

GAGE SERIES DATA — See Gage Series datasheet for complete specifications				
Series	Description	Strain Range	Temperature Range	
EA	Constantan foil in combination with a tough, flexible, polyimide backing.	±3%	-100° to +350°F (-75° to +175°C)	
WA	Fully encapsulated constantan gages with high-endurance leadwires.	±2%	-100° to +400°F (-75° to +205°C)	
WK	Fully encapsulated K-alloy gages with high-endurance leadwires.	±1.5%	-452° to +550°F (-269° to +290°C)	
SA	Fully encapsulated constantan gages with solder dots.	±2%	-100° to +400°F (-75° to +205°C)	
SK	Fully encapsulated K-alloy gages with solder dots.	±1.5%	-452° to +450°F (-269° to +230°C)	

Note 1: Insert desired S-T-C number in spaces marked XX.

Note 2: Tolerance is increased when Option W, E, SE, LE, or P is specified.

Note 3: Products with designations and options shown in **bold** are not RoHS compliant.

*Options available but not normally recommended. See Optional Features data sheet for details.

General Purpose Strain Gages – Linear Pattern

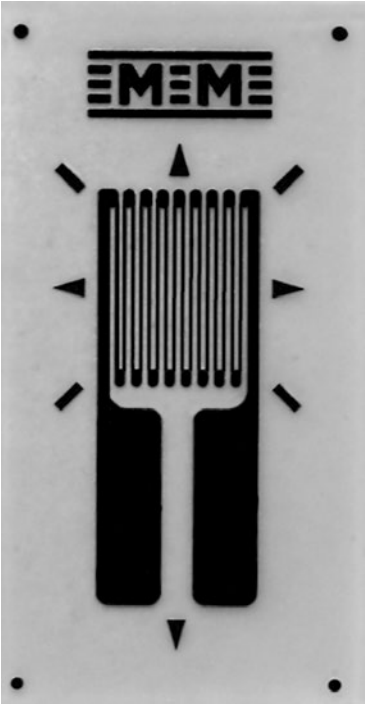
GAGE PATTERN DATA					
		GAGE DESIGNATION See Note 1	RESISTANCE (OHMS) See Note 2	OPTIONS AVAILABLE See Note 3	
		EA-XX-062AK-120 ED-DY-062AK-350 EP-08-062AK-120	120 ± 0.15% 350 ± 0.4% 120 ± 0.15%	E, P E	
DESCRIPTION General-purpose gage with elongated solder tabs. See the 062AP pattern for WA, WK, and other series with this grid size.					
GAGE DIMENSIONS		Legend ES = Each Section CP = Complete Pattern S = Section (S1 = Section 1) M = Matrix			<input type="checkbox"/> inch <input checked="" type="checkbox"/> millimeter
Gage Length	Overall Length	Grid Width	Overall Width	Matrix Length	Matrix Width
0.062	0.160	0.062	0.062	0.27	0.14
1.57	4.06	1.57	1.57	6.9	3.6



GAGE SERIES DATA — See Gage Series datasheet for complete specifications			
Series	Description	Strain Range	Temperature Range
EA	Constantan foil in combination with a tough, flexible, polyimide backing.	±3%	-100° to +350°F (-75° to +175°C)
ED	Isoelastic foil in combination with tough, flexible polyimide film.	±2%	-320° to +400°F (-195° to +205°C)
EP	Annealed constantan foil with tough, high-elongation polyimide backing.	±10%	-100° to +400°F (-75° to +205°C)

Note 1: Insert desired S-T-C number in spaces marked XX.

Note 2: Tolerance is increased when Option W, E, SE, LE, or P is specified.

Note 3: Products with designations and options shown in **bold** are not RoHS compliant.

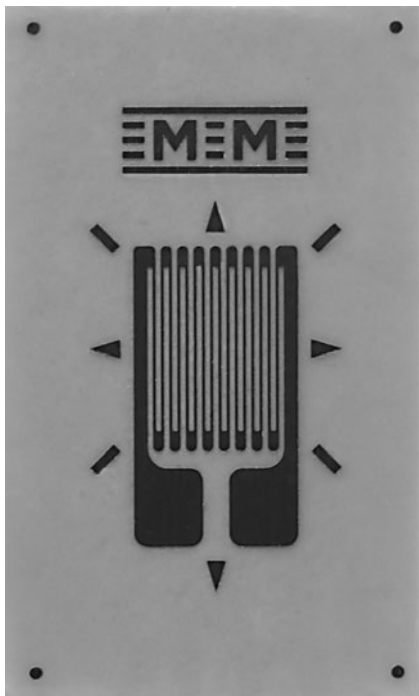
General Purpose Strain Gages – Linear Pattern

GAGE PATTERN DATA					
		 actual size	GAGE DESIGNATION See Note 1, 3	RESISTANCE (OHMS) See Note 2	OPTIONS AVAILABLE See Note 3
			EA-XX-062AP-120 ED-DY-062AP-350 EK-XX-062AP-350 WA-XX-062AP-120 WK-XX-062AP-350 EP-XX-062AP-120 SA-XX-062AP-120 SK-XX-062AP-350 SD-DY-062AP-350 WD-DY-062AP-350	120 ± 0.15% 350 ± 0.4% 350 ± 0.15% 120 ± 0.3% 350 ± 0.3% 120 ± 0.15% 120 ± 0.3% 350 ± 0.3% 350 ± 0.8% 350 ± 0.8%	W, E, L, LE, P E, L*, LE* W, SE W* W*
DESCRIPTION Widely used general-purpose gage. See also 062UW pattern. EK-Series gages are supplied with duplex copper pads (DP) when optional feature W or SE is not specified.					
GAGE DIMENSIONS		Legend ES = Each Section CP = Complete Pattern S = Section (S1 = Section 1) M = Matrix			<input type="checkbox"/> inch <input type="checkbox"/> millimeter
Gage Length	Overall Length	Grid Width	Overall Width	Matrix Length	Matrix Width
0.062	0.114	0.062	0.062	0.26	0.16
1.57	2.90	1.57	1.57	6.6	4.1

GAGE SERIES DATA — See Gage Series datasheet for complete specifications			
Series	Description	Strain Range	Temperature Range
EA	Constantan foil in combination with a tough, flexible, polyimide backing.	±3%	-100° to +350°F (-75° to +175°C)
ED	Isoelastic foil in combination with tough, flexible polyimide film.	±2%	-320° to +400°F (-195° to +205°C)
EK	K-alloy foil in combination with a tough, flexible polyimide backing.	±1.5%	-320° to +350°F (-195° to +175°C)
WA	Fully encapsulated constantan gages with high-endurance leadwires.	±2%	-100° to +400°F (-75° to +205°C)
WK	Fully encapsulated K-alloy gages with high-endurance leadwires.	±1.5%	-452° to +550°F (-269° to +290°C)
EP	Annealed constantan foil with tough, high-elongation polyimide backing.	±10%	-100° to +400°F (-75° to +205°C)
SA	Fully encapsulated constantan gages with solder dots.	±2%	-100° to +400°F (-75° to +205°C)
SK	Fully encapsulated K-alloy gages with solder dots.	±1.5%	-452° to +450°F (-269° to +230°C)
SD	Equivalent to WD Series, but with solder dots instead of leadwires.	±1.5%	-320° to +400°F (-195° to +205°C)
WD	Fully encapsulated isoelastic gages with high-endurance leadwires.	±1.5%	-320° to +500°F (-195° to +260°C)

Note 1: Insert desired S-T-C number in spaces marked XX.

Note 2: Tolerance is increased when Option W, E, SE, LE, or P is specified.

Note 3: Products with designations and options shown in **bold** are not RoHS compliant.

*Options available but not normally recommended. See Optional Features data sheet for details.

General Purpose Strain Gages – Linear Pattern

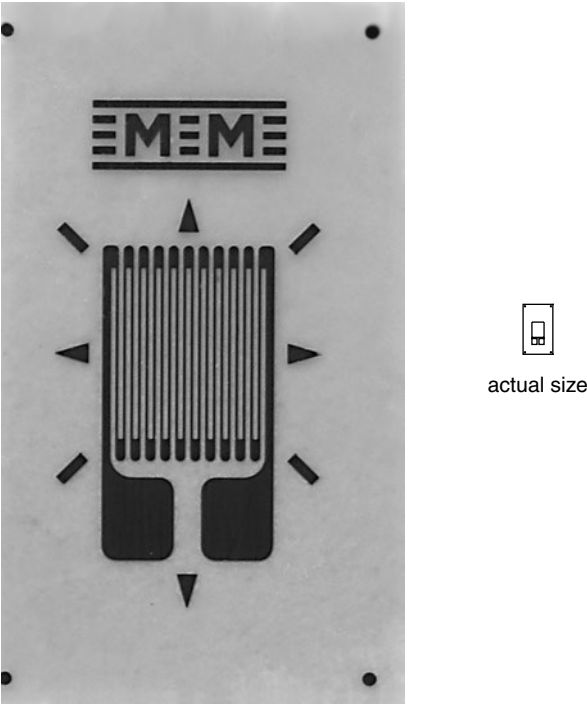
GAGE PATTERN DATA					
		GAGE DESIGNATION See Note 1, 3	RESISTANCE (OHMS) See Note 2	OPTIONS AVAILABLE See Note 3	
		EA-XX-062AQ-350 ED-DY-062AQ-500 WA-XX-062AQ-350 WK-XX-062AQ-500 EP-08-062AQ-350 SA-XX-062AQ-350 SK-XX-062AQ-500 SD-DY-062AQ-500 WD-DY-062AQ-500	350 ± 0.15% 500 ± 0.4% 350 ± 0.3% 500 ± 0.3% 350 ± 0.15% 350 ± 0.3% 500 ± 0.3% 500 ± 0.8% 500 ± 0.8%	W, E, L, LE, P E, L*, LE* W* W*	
DESCRIPTION General-purpose gage. Similar to 062AP pattern but with high-resistance grid. See also 062UW pattern.					
GAGE DIMENSIONS		Legend ES = Each Section CP = Complete Pattern S = Section (S1 = Section 1) M = Matrix			<input type="checkbox"/> inch <input type="checkbox"/> millimeter
Gage Length	Overall Length	Grid Width	Overall Width	Matrix Length	Matrix Width
0.062	0.114	0.062	0.062	0.26	0.15
1.57	2.90	1.57	1.57	6.6	3.8

GAGE SERIES DATA — See Gage Series datasheet for complete specifications			
Series	Description	Strain Range	Temperature Range
EA	Constantan foil in combination with a tough, flexible, polyimide backing.	±3%	-100° to +350°F (-75° to +175°C)
ED	Isoelastic foil in combination with tough, flexible polyimide film.	±2%	-320° to +400°F (-195° to +205°C)
WA	Fully encapsulated constantan gages with high-endurance leadwires.	±2%	-100° to +400°F (-75° to +205°C)
WK	Fully encapsulated K-alloy gages with high-endurance leadwires.	±1.5%	-452° to +550°F (-269° to +290°C)
EP	Annealed constantan foil with tough, high-elongation polyimide backing.	±10%	-100° to +400°F (-75° to +205°C)
SA	Fully encapsulated constantan gages with solder dots.	±2%	-100° to +400°F (-75° to +205°C)
SK	Fully encapsulated K-alloy gages with solder dots.	±1.5%	-452° to +450°F (-269° to +230°C)
SD	Equivalent to WD Series, but with solder dots instead of leadwires.	±1.5%	-320° to +400°F (-195° to +205°C)
WD	Fully encapsulated isoelastic gages with high-endurance leadwires.	±1.5%	-320° to +500°F (-195° to +260°C)

Note 1: Insert desired S-T-C number in spaces marked XX.

Note 2: Tolerance is increased when Option W, E, SE, LE, or P is specified.

Note 3: Products with designations and options shown in **bold** are not RoHS compliant.

*Options available but not normally recommended. See Optional Features data sheet for details.

General Purpose Strain Gages – Linear Pattern

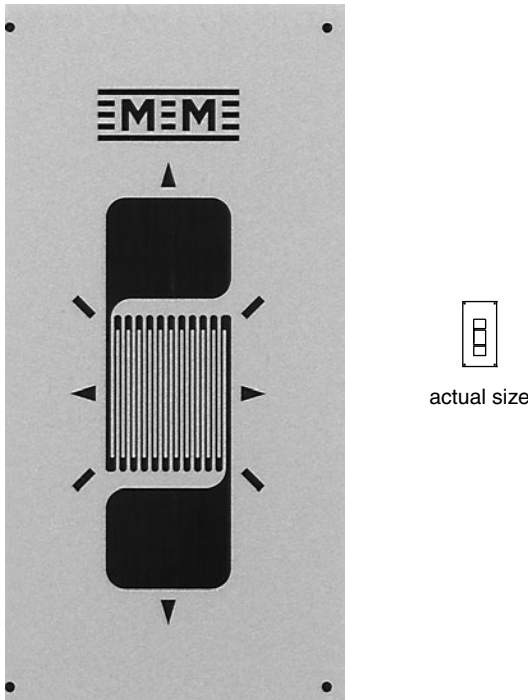
GAGE PATTERN DATA						
		GAGE DESIGNATION See Note 1, 3	RESISTANCE (OHMS) See Note 2	OPTIONS AVAILABLE See Note 3		
		EA-XX-062DN-350 ED-DY-062DN-500 WA-XX-062DN-350 WK-XX-062DN-500 EP-08-062DN-350 SA-XX-062DN-350 SK-XX-062DN-500 SD-DY-062DMN-500 WD-DY-062DN-500	350 ± 0.15% 500 ± 0.4% 350 ± 0.3% 500 ± 0.3% 350 ± 0.15% 350 ± 0.3% 500 ± 0.3% 500 ± 0.8% 500 ± 0.8%	E, L, LE E, L*, LE*		
DESCRIPTION Similar to 062DF pattern except for grid resistance.						
GAGE DIMENSIONS		Legend ES = Each Section CP = Complete Pattern S = Section (S1 = Section 1) M = Matrix			<input type="checkbox"/> inch <input type="checkbox"/> millimeter	
Gage Length	Overall Length	Grid Width	Overall Width	Matrix Length	Matrix Width	
0.062	0.190	0.062	0.062	0.34	0.18	
1.57	4.83	1.57	1.57	8.6	4.6	

GAGE SERIES DATA — See Gage Series datasheet for complete specifications			
Series	Description	Strain Range	Temperature Range
EA	Constantan foil in combination with a tough, flexible, polyimide backing.	±3%	-100° to +350°F (-75° to +175°C)
ED	Isoelastic foil in combination with tough, flexible polyimide film.	±2%	-320° to +400°F (-195° to +205°C)
WA	Fully encapsulated constantan gages with high-endurance leadwires.	±2%	-100° to +400°F (-75° to +205°C)
WK	Fully encapsulated K-alloy gages with high-endurance leadwires.	±1.5%	-452° to +550°F (-269° to +290°C)
EP	Annealed constantan foil with tough, high-elongation polyimide backing.	±10%	-100° to +400°F (-75° to +205°C)
SA	Fully encapsulated constantan gages with solder dots.	±2%	-100° to +400°F (-75° to +205°C)
SK	Fully encapsulated K-alloy gages with solder dots.	±1.5%	-452° to +450°F (-269° to +230°C)
SD	Equivalent to WD Series, but with solder dots instead of leadwires.	±1.5%	-320° to +400°F (-195° to +205°C)
WD	Fully encapsulated isoelastic gages with high-endurance leadwires.	±1.5%	-320° to +500°F (-195° to +260°C)



Note 1: Insert desired S-T-C number in spaces marked XX.

Note 2: Tolerance is increased when Option W, E, SE, LE, or P is specified.

Note 3: Products with designations and options shown in **bold** are not RoHS compliant.

*Options available but not normally recommended. See Optional Features data sheet for details.

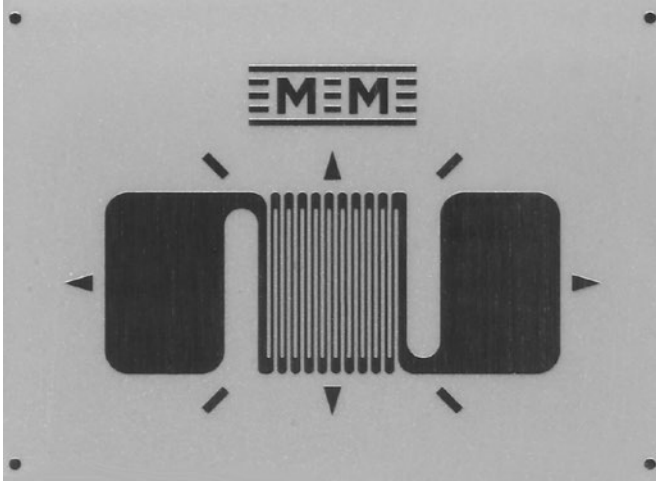
General Purpose Strain Gages – Linear Pattern

GAGE PATTERN DATA					
   actual size		GAGE DESIGNATION See Note 1, 3	RESISTANCE (OHMS) See Note 2	OPTIONS AVAILABLE See Note 3	
		EA-XX-062ED-120 ED-DY-062ED-350 WA-XX-062ED-120 WK-XX-062ED-350 EP-08-062ED-120 SA-XX-062ED-350 SK-XX-062ED-350 SD-DY-062ED-350 WD-DY-062ED-350	120 ± 0.15% 350 ± 0.4% 120 ± 0.3% 350 ± 0.3% 120 ± 0.15% 120 ± 0.3% 350 ± 0.3% 350 ± 0.8% 350 ± 0.8%	E, L, LE E, L*, LE**	
DESCRIPTION General-purpose gage. Similar to 062EN pattern except for grid resistance.					
GAGE DIMENSIONS		Legend ES = Each Section CP = Complete Pattern S = Section (S1 = Section 1) M = Matrix			
				inch	
				millimeter	
Gage Length	Overall Length	Grid Width	Overall Width	Matrix Length	Matrix Width
0.062	0.076	0.062	0.190	0.21	0.29
1.57	1.93	1.57	4.83	5.3	7.4

GAGE SERIES DATA — See Gage Series datasheet for complete specifications			
Series	Description	Strain Range	Temperature Range
EA	Constantan foil in combination with a tough, flexible, polyimide backing.	±3%	-100° to +350°F (-75° to +175°C)
ED	Isoelastic foil in combination with tough, flexible polyimide film.	±2%	-320° to +400°F (-195° to +205°C)
WA	Fully encapsulated constantan gages with high-endurance leadwires.	±2%	-100° to +400°F (-75° to +205°C)
WK	Fully encapsulated K-alloy gages with high-endurance leadwires.	±1.5%	-452° to +550°F (-269° to +290°C)
EP	Annealed constantan foil with tough, high-elongation polyimide backing.	±10%	-100° to +400°F (-75° to +205°C)
SA	Fully encapsulated constantan gages with solder dots.	±2%	-100° to +400°F (-75° to +205°C)
SK	Fully encapsulated K-alloy gages with solder dots.	±1.5%	-452° to +450°F (-269° to +230°C)
SD	Equivalent to WD Series, but with solder dots instead of leadwires.	±1.5%	-320° to +400°F (-195° to +205°C)
WD	Fully encapsulated isoelastic gages with high-endurance leadwires.	±1.5%	-320° to +500°F (-195° to +260°C)



Note 1: Insert desired S-T-C number in spaces marked XX.

Note 2: Tolerance is increased when Option W, E, SE, LE, or P is specified.

Note 3: Products with designations and options shown in **bold** are not RoHS compliant.

*Options available but not normally recommended. See Optional Features data sheet for details.

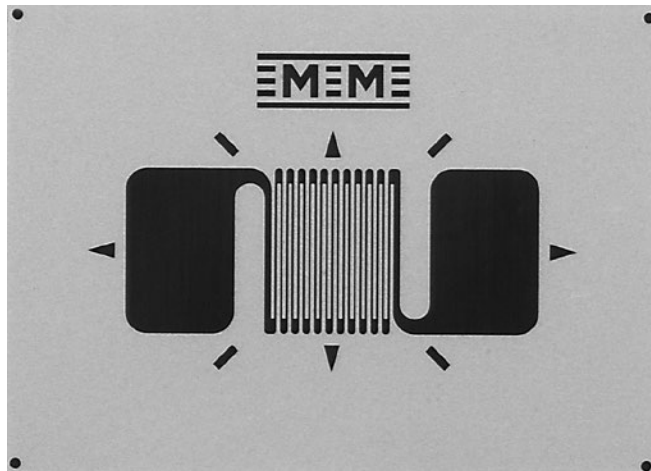
General Purpose Strain Gages – Linear Pattern

GAGE PATTERN DATA							
		GAGE DESIGNATION See Note 1, 3	RESISTANCE (OHMS) See Note 2	OPTIONS AVAILABLE See Note 3			
		EA-XX-062EN-350 ED-DY-062EN-500 WA-XX-062EN-350 WK-XX-062EN-500 EP-08-062EN-350 SA-XX-062EN-350 SK-XX-062EN-500 SD-DY-062EN-500 WD-DY-062EN-500	350 ± 0.15% 500 ± 0.4% 350 ± 0.3% 500 ± 0.3% 350 ± 0.15% 350 ± 0.3% 500 ± 0.3% 500 ± 0.8% 500 ± 0.8%	E, L, LE E, L*, LE*			
 actual size		DESCRIPTION Similar to 062ED pattern except for grid resistance.					
GAGE DIMENSIONS		Legend ES = Each Section S = Section (S1 = Section 1)			<table border="1"> <tr><td>inch</td></tr> <tr><td>millimeter</td></tr> </table>	inch	millimeter
inch							
millimeter							
Gage Length	Overall Length	Grid Width	Overall Width	Matrix Length	Matrix Width		
0.062	0.076	0.062	0.190	0.23	0.31		
1.57	1.93	1.57	4.83	5.8	7.9		

GAGE SERIES DATA — See Gage Series datasheet for complete specifications			
Series	Description	Strain Range	Temperature Range
EA	Constantan foil in combination with a tough, flexible, polyimide backing.	±3%	-100° to +350°F (-75° to +175°C)
ED	Isoelastic foil in combination with tough, flexible polyimide film.	±2%	-320° to +400°F (-195° to +205°C)
WA	Fully encapsulated constantan gages with high-endurance leadwires.	±2%	-100° to +400°F (-75° to +205°C)
WK	Fully encapsulated K-alloy gages with high-endurance leadwires.	±1.5%	-452° to +550°F (-269° to +290°C)
EP	Annealed constantan foil with tough, high-elongation polyimide backing.	±10%	-100° to +400°F (-75° to +205°C)
SA	Fully encapsulated constantan gages with solder dots.	±2%	-100° to +400°F (-75° to +205°C)
SK	Fully encapsulated K-alloy gages with solder dots.	±1.5%	-452° to +450°F (-269° to +230°C)
SD	Equivalent to WD Series, but with solder dots instead of leadwires.	±1.5%	-320° to +400°F (-195° to +205°C)
WD	Fully encapsulated isoelastic gages with high-endurance leadwires.	±1.5%	-320° to +500°F (-195° to +260°C)



Note 1: Insert desired S-T-C number in spaces marked XX.

Note 2: Tolerance is increased when Option W, E, SE, LE, or P is specified.

Note 3: Products with designations and options shown in **bold** are not RoHS compliant.

*Options available but not normally recommended. See Optional Features data sheet for details.

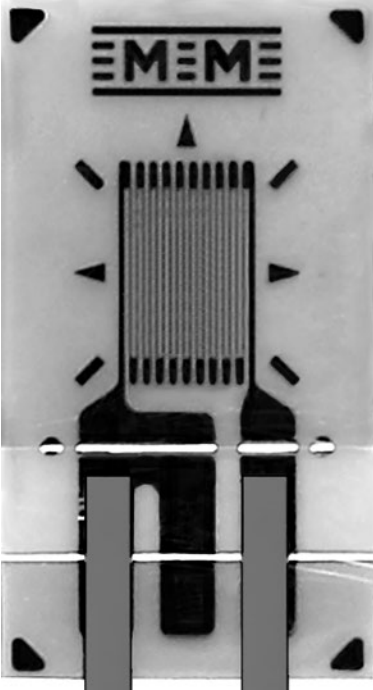
General Purpose Strain Gages – Linear Pattern

GAGE PATTERN DATA					
		GAGE DESIGNATION See Note 1	RESISTANCE (OHMS)	OPTIONS AVAILABLE	
		L2A-XX-062LW-120 L2A-XX-062LW-350 C2A-XX-062LW-120 C2A-XX-062LW-350	120 ± 0.6% 350 ± 0.6% 120 ± 0.6% 350 ± 0.6%		
		DESCRIPTION Widely used general-purpose gage.			
GAGE DIMENSIONS		Legend ES = Each Section CP = Complete Pattern S = Section (S1 = Section 1) M = Matrix			<input type="checkbox"/> inch <input type="checkbox"/> millimeter
Gage Length	Overall Length	Grid Width	Overall Width	Matrix Length	Matrix Width
0.062	0.175	0.050	0.080	0.252	0.170
1.52	4.45	1.27	2.03	6.40	4.32

GAGE SERIES DATA — See Gage Series datasheet for complete specifications			
Series	Description	Strain Range	Temperature Range
L2A	Encapsulated constantan gages with preattached ribbon leads.	±3%	-100° to +250°F (-75° to +120°C)
C2A	Encapsulated constantan gages with preattached ready-to-use cables.	±3%	-60° to +180°F (-50° to +80°C)



Example of an
L2A Construction



Example of an
C2A Construction

Note 1: Insert desired S-T-C number in spaces marked XX.

General Purpose Strain Gages – Linear Pattern

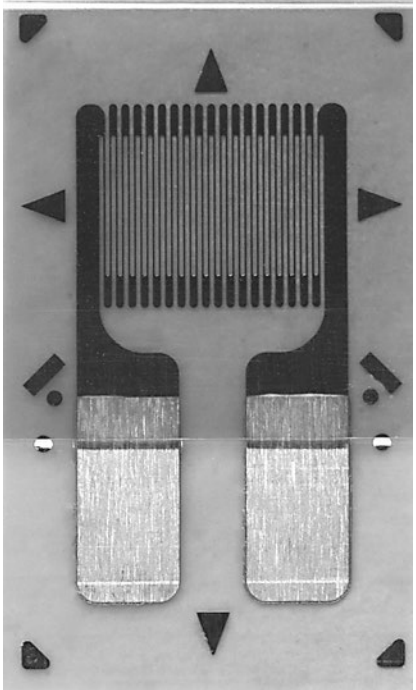
GAGE PATTERN DATA					
 <p>actual size</p>		GAGE DESIGNATION See Note 1	RESISTANCE (OHMS)	OPTIONS AVAILABLE See Note 2	
		CEA-XX-062UW-120 CEA-XX-062UW-350	120 ± 0.3% 350 ± 0.3%	P2 P2	
DESCRIPTION General-purpose gage. Exposed solder tab area is 0.07 x 0.04 in [1.8 x 1.0 mm].					
GAGE DIMENSIONS		Legend ES = Each Section CP = Complete Pattern S = Section (S1 = Section 1) M = Matrix			
				<input type="checkbox"/> inch <input type="checkbox"/> millimeter	
Gage Length	Overall Length	Grid Width	Overall Width	Matrix Length	Matrix Width
0.062	0.220	0.120	0.120	0.31	0.19
1.57	5.59	3.05	3.05	7.9	4.8

GAGE SERIES DATA — See Gage Series datasheet for complete specifications			
Series	Description	Strain Range	Temperature Range
CEA	Universal general-purpose strain gages.	±3%	-100° to +350°F (-75° to +175°C)

Note 1: Insert desired S-T-C number in spaces marked XX.

Note 2: Products with designations and options shown in **bold** are not RoHS compliant.

General Purpose Strain Gages—Linear Pattern

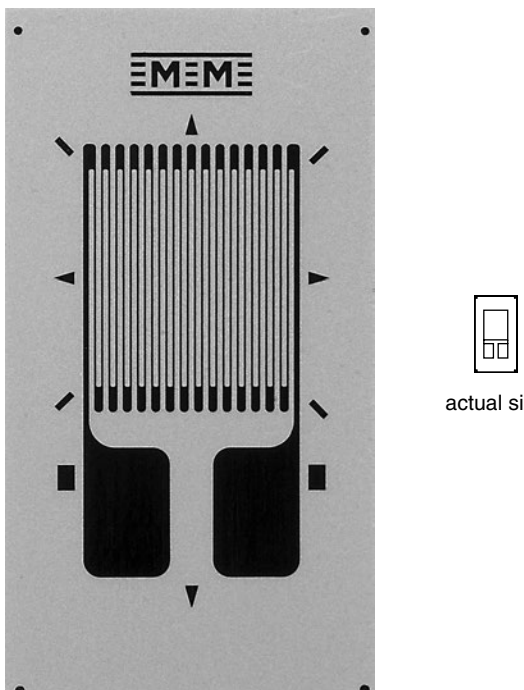
GAGE PATTERN DATA					
	<p>GAGE DESIGNATION See Note 1, 3</p>	<p>RESISTANCE (OHMS) See Note 2</p>	<p>OPTIONS AVAILABLE See Note 3</p>		
	<p>EA-XX-125AC-350 ED-DY-125AC-10C EK-XX-125AC-10C S2K-XX-125AC-10C WA-XX-125AC-350 WK-XX-125AC-10C EP-08-125AC-350 SA-XX-125AC-350 SK-XX-125AC-10C SD-DY-125AC-10C WD-DY-125AC-10C</p>	<p>350 ± 0.15% 1000 ± 0.3% 1000 ± 0.15% 1000 ± 0.3% 350 ± 0.3% 1000 ± 0.3% 350 ± 0.15% 350 ± 0.3% 1000 ± 0.3% 1000 ± 0.6% 1000 ± 0.6%</p>	<p>W, E, L, LE, P E, L*, LE* W, SE W* W*</p>		
<p>DESCRIPTION</p> <p>Widely used general-purpose gage with high-resistance grid. See also 125AD, 125UN, and 125UW patterns. EK-Series gages are supplied with duplex copper pads (DP) when optional feature W or SE is not specified.</p>					
GAGE DIMENSIONS		<p>Legend</p> <p>ES = Each Section CP = Complete Pattern S = Section (S1 = Section 1) M = Matrix</p>			
				inch	
				millimeter	
Gage Length	Overall Length	Grid Width	Overall Width	Matrix Length	Matrix Width
0.125	0.250	0.125	0.125	0.40	0.22
3.18	6.35	3.18	3.18	10.2	5.6

GAGE SERIES DATA — See Gage Series datasheet for complete specifications			
Series	Description	Strain Range	Temperature Range
EA	Constantan foil in combination with a tough, flexible, polyimide backing.	±5%	-100° to +350°F (-75° to +175°C)
ED	Isoelastic foil in combination with tough, flexible polyimide film.	±2%	-320° to +400°F (-195° to +205°C)
EK	K-alloy foil in combination with a tough, flexible polyimide backing.	±1.5%	-320° to +350°F (-195° to +175°C)
S2K	K-alloy foil with laminated thick, high-performance polyimide backing.	±1.5%	-100° to +250°F (-75° to +120°C)
WA	Fully encapsulated constantan gages with high-endurance leadwires.	±2%	-100° to +400°F (-75° to +205°C)
WK	Fully encapsulated K-alloy gages with high-endurance leadwires.	±1.5%	-452° to +550°F (-269° to +290°C)
EP	Annealed constantan foil with tough, high-elongation polyimide backing.	±20%	-100° to +400°F (-75° to +205°C)
SA	Fully encapsulated constantan gages with solder dots.	±2%	-100° to +400°F (-75° to +205°C)
SK	Fully encapsulated K-alloy gages with solder dots.	±1.5%	-452° to +450°F (-269° to +230°C)
SD	Equivalent to WD Series, but with solder dots instead of leadwires.	±1.5%	-320° to +400°F (-195° to +205°C)
WD	Fully encapsulated isoelastic gages with high-endurance leadwires.	±1.5%	-320° to +500°F (-195° to +260°C)

Note 1: Insert desired S-T-C number in spaces marked XX.

Note 2: Tolerance is increased when Option W, E, SE, LE, or P is specified.

Note 3: Products with designations and options shown in **bold** are not RoHS compliant.

*Options available but not normally recommended. See Optional Features data sheet for details.

General Purpose Strain Gages – Linear Pattern

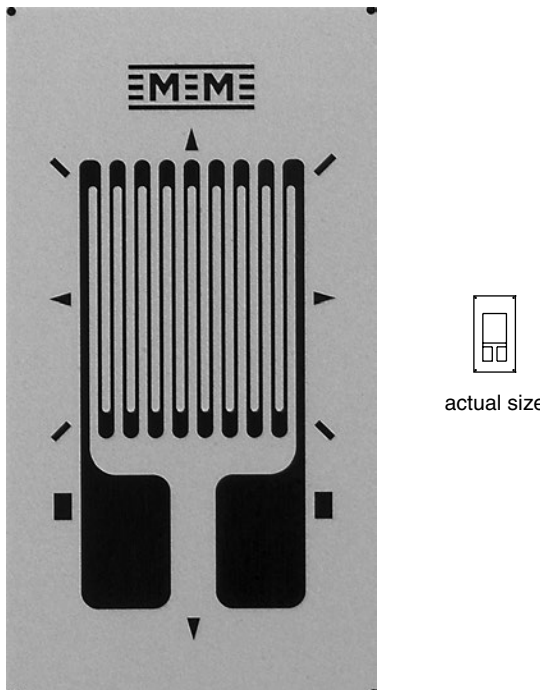
GAGE PATTERN DATA							
		GAGE DESIGNATION See Note 1, 3	RESISTANCE (OHMS) See Note 2	OPTIONS AVAILABLE See Note 3			
		EA-XX-125AD-120 ED-DY-125AD-350 EK-XX-125AD-350 WA-XX-125AD-120 WK-XX-125AD-350 EP-XX-125AD-120 SA-XX-125AD-120 SK-XX-125AD-350 SD-DY-125AD-350 WD-DY-125AD-350	120 ± 0.15% 350 ± 0.3% 350 ± 0.15% 120 ± 0.3% 350 ± 0.3% 120 ± 0.15% 120 ± 0.3% 350 ± 0.3% 350 ± 0.6% 350 ± 0.6%	W, E, L, LE, P E, L*, LE* W, SE W* W*			
DESCRIPTION Widely used general-purpose gage. EK-Series gages are supplied with duplex copper pads (DP) when optional feature W or SE is not specified.							
GAGE DIMENSIONS		Legend ES = Each Section CP = Complete Pattern S = Section (S1 = Section 1) M = Matrix					
				<table border="1"> <tr><td>inch</td></tr> <tr><td>millimeter</td></tr> </table>	inch	millimeter	
inch							
millimeter							
Gage Length	Overall Length	Grid Width	Overall Width	Matrix Length	Matrix Width		
0.125	0.250	0.125	0.125	0.40	0.22		
3.18	6.35	3.18	3.18	10.2	5.6		

GAGE SERIES DATA — See Gage Series datasheet for complete specifications			
Series	Description	Strain Range	Temperature Range
EA	Constantan foil in combination with a tough, flexible, polyimide backing.	±5%	-100° to +350°F (-75° to +175°C)
ED	Isoelastic foil in combination with tough, flexible polyimide film.	±2%	-320° to +400°F (-195° to +205°C)
EK	K-alloy foil in combination with a tough, flexible polyimide backing.	±1.5%	-320° to +350°F (-195° to +175°C)
WA	Fully encapsulated constantan gages with high-endurance leadwires.	±2%	-100° to +400°F (-75° to +205°C)
WK	Fully encapsulated K-alloy gages with high-endurance leadwires.	±1.5%	-452° to +550°F (-269° to +290°C)
EP	Annealed constantan foil with tough, high-elongation polyimide backing.	±20%	-100° to +400°F (-75° to +205°C)
SA	Fully encapsulated constantan gages with solder dots.	±2%	-100° to +400°F (-75° to +205°C)
SK	Fully encapsulated K-alloy gages with solder dots.	±1.5%	-452° to +450°F (-269° to +230°C)
SD	Equivalent to WD Series, but with solder dots instead of leadwires.	±1.5%	-320° to +400°F (-195° to +205°C)
WD	Fully encapsulated isoelastic gages with high-endurance leadwires.	±1.5%	-320° to +500°F (-195° to +260°C)

Note 1: Insert desired S-T-C number in spaces marked XX.

Note 2: Tolerance is increased when Option W, E, SE, LE, or P is specified.

Note 3: Products with designations and options shown in **bold** are not RoHS compliant.

*Options available but not normally recommended. See Optional Features data sheet for details.

General Purpose Strain Gages – Linear Pattern

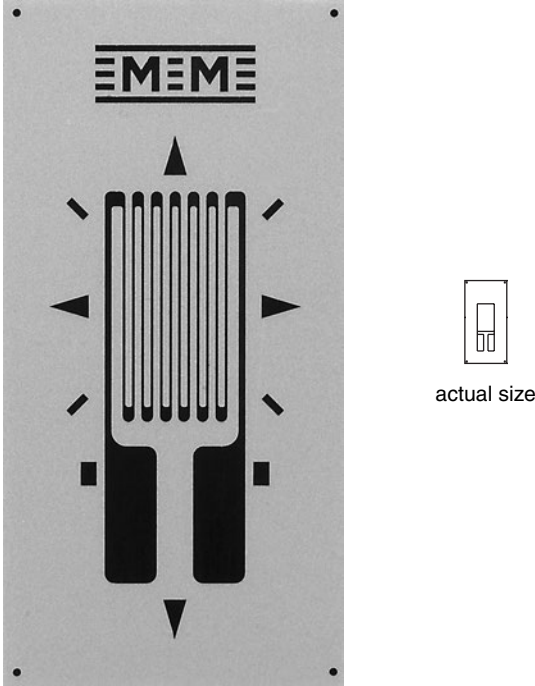
GAGE PATTERN DATA					
		GAGE DESIGNATION See Note 1, 3	RESISTANCE (OHMS) See Note 2	OPTIONS AVAILABLE See Note 3	
		EA-XX-125BB-120 ED-DY-125BB-350 WA-XX-125BB-120 WK-XX-125BB-350 EP-08-125BB-120 SA-XX-125BB-120 SK-XX-125BB-350 SD-DY-125BB-350 WD-DY-125BB-350	120 ± 0.15% 350 ± 0.3% 120 ± 0.3% 350 ± 0.3% 120 ± 0.15% 120 ± 0.3% 350 ± 0.3% 350 ± 0.6% 350 ± 0.6%	E, P E	
DESCRIPTION Narrow general-purpose gage with extended tabs.					
GAGE DIMENSIONS		Legend ES = Each Section CP = Complete Pattern S = Section (S1 = Section 1) M = Matrix			
				<input type="checkbox"/> inch <input type="checkbox"/> millimeter	
Gage Length	Overall Length	Grid Width	Overall Width	Matrix Length	Matrix Width
0.125	0.245	0.088	0.088	0.43	0.22
3.18	6.22	2.24	2.24	10.9	5.6

GAGE SERIES DATA — See Gage Series datasheet for complete specifications			
Series	Description	Strain Range	Temperature Range
EA	Constantan foil in combination with a tough, flexible, polyimide backing.	±5%	-100° to +350°F (-75° to +175°C)
ED	Isoelastic foil in combination with tough, flexible polyimide film.	±2%	-320° to +400°F (-195° to +205°C)
WA	Fully encapsulated constantan gages with high-endurance leadwires.	±2%	-100° to +400°F (-75° to +205°C)
WK	Fully encapsulated K-alloy gages with high-endurance leadwires.	±1.5%	-452° to +550°F (-269° to +290°C)
EP	Annealed constantan foil with tough, high-elongation polyimide backing.	±20%	-100° to +400°F (-75° to +205°C)
SA	Fully encapsulated constantan gages with solder dots.	±2%	-100° to +400°F (-75° to +205°C)
SK	Fully encapsulated K-alloy gages with solder dots.	±1.5%	-452° to +450°F (-269° to +230°C)
SD	Equivalent to WD Series, but with solder dots instead of leadwires.	±1.5%	-320° to +400°F (-195° to +205°C)
WD	Fully encapsulated isoelastic gages with high-endurance leadwires.	±1.5%	-320° to +500°F (-195° to +260°C)

Note 1: Insert desired S-T-C number in spaces marked XX.

Note 2: Tolerance is increased when Option W, E, SE, LE, or P is specified.

Note 3: Products with designations and options shown in **bold** are not RoHS compliant.

General Purpose Strain Gages – Linear Pattern

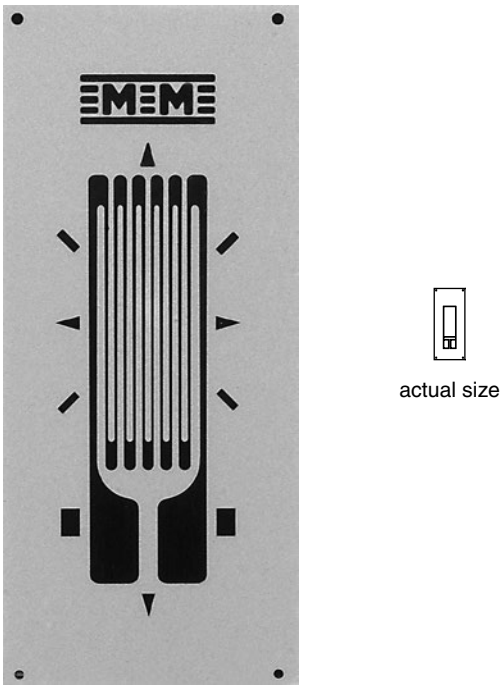
GAGE PATTERN DATA					
		GAGE DESIGNATION See Note 1, 3	RESISTANCE (OHMS) See Note 2	OPTIONS AVAILABLE See Note 3	
		EA-XX-125BT-120 ED-DY-125BT-350 WA-XX-125BT-120 WK-XX-125BT-350 EP-08-125BT-120 SA-XX-125BT-120 SK-XX-125BT-350 SD-DY-125BT-350 WD-DY-125BT-350	120 ± 0.15% 350 ± 0.3% 120 ± 0.3% 350 ± 0.3% 120 ± 0.15% 120 ± 0.3% 350 ± 0.3% 350 ± 0.6% 350 ± 0.6%	W, E, L, LE, P E, L*, LE* W* W*	
DESCRIPTION General-purpose gage with narrow grid and compact geometry. See also 125BZ pattern.					
GAGE DIMENSIONS		Legend ES = Each Section CP = Complete Pattern S = Section (S1 = Section 1) M = Matrix			
				inch millimeter	
Gage Length	Overall Length	Grid Width	Overall Width	Matrix Length	Matrix Width
0.125	0.215	0.062	0.062	0.37	0.16
3.18	5.46	1.57	1.57	9.4	4.1

GAGE SERIES DATA — See Gage Series datasheet for complete specifications			
Series	Description	Strain Range	Temperature Range
EA	Constantan foil in combination with a tough, flexible, polyimide backing.	±5%	-100° to +350°F (-75° to +175°C)
ED	Isoelastic foil in combination with tough, flexible polyimide film.	±2%	-320° to +400°F (-195° to +205°C)
WA	Fully encapsulated constantan gages with high-endurance leadwires.	±2%	-100° to +400°F (-75° to +205°C)
WK	Fully encapsulated K-alloy gages with high-endurance leadwires.	±1.5%	-452° to +550°F (-269° to +290°C)
EP	Annealed constantan foil with tough, high-elongation polyimide backing.	±20%	-100° to +400°F (-75° to +205°C)
SA	Fully encapsulated constantan gages with solder dots.	±2%	-100° to +400°F (-75° to +205°C)
SK	Fully encapsulated K-alloy gages with solder dots.	±1.5%	-452° to +450°F (-269° to +230°C)
SD	Equivalent to WD Series, but with solder dots instead of leadwires.	±1.5%	-320° to +400°F (-195° to +205°C)
WD	Fully encapsulated isoelastic gages with high-endurance leadwires.	±1.5%	-320° to +500°F (-195° to +260°C)

Note 1: Insert desired S-T-C number in spaces marked XX.

Note 2: Tolerance is increased when Option W, E, SE, LE, or P is specified.

Note 3: Products with designations and options shown in **bold** are not RoHS compliant.

*Options available but not normally recommended. See Optional Features data sheet for details.

General Purpose Strain Gages – Linear Pattern

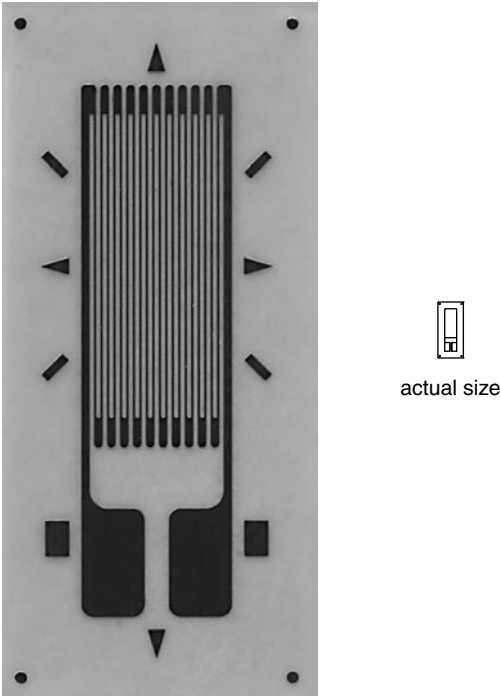
GAGE PATTERN DATA							
 <p>actual size</p>		<p>GAGE DESIGNATION See Note 1, 3</p>	<p>RESISTANCE (OHMS) See Note 2</p>	<p>OPTIONS AVAILABLE See Note 3</p>			
		<p>EA-XX-125BZ-350 ED-DY-125BZ-10C EK-XX-125BZ-10C WA-XX-125BZ-350 WK-XX-125BZ-10C SA-XX-125BZ-350 SK-XX-125BZ-10C SD-DY-125BZ-10C WD-DY-125BZ-10C</p>	<p>350 ± 0.15% 1000 ± 0.4% 1000 ± 0.15% 350 ± 0.3% 1000 ± 0.3% 350 ± 0.3% 1000 ± 0.3% 1000 ± 0.8% 1000 ± 0.8%</p>	<p>W, E, L, LE, P E, L*, LE* W* W*</p>			
<p>DESCRIPTION</p> <p>Narrow high-resistance gage with compact geometry. Similar to 125BT pattern except for grid resistance. EK-Series gages are supplied with duplex copper dots(DD) when optional feature W is not specified.</p>							
GAGE DIMENSIONS		<p>Legend</p> <p>ES = Each Section CP = Complete Pattern S = Section (S1 = Section 1) M = Matrix</p>			<table border="1"> <tr><td>inch</td></tr> <tr><td>millimeter</td></tr> </table>	inch	millimeter
inch							
millimeter							
Gage Length	Overall Length	Grid Width	Overall Width	Matrix Length	Matrix Width		
0.125	0.220	0.062	0.062	0.29	0.13		
3.18	5.59	1.57	1.57	7.4	3.3		

GAGE SERIES DATA — See Gage Series datasheet for complete specifications			
Series	Description	Strain Range	Temperature Range
EA	Constantan foil in combination with a tough, flexible, polyimide backing.	±5%	-100° to +350°F (-75° to +175°C)
ED	Isoelastic foil in combination with tough, flexible polyimide film.	±2%	-320° to +400°F (-195° to +205°C)
EK	K-alloy foil in combination with a tough, flexible polyimide backing.	±1.5%	-320° to +350°F (-195° to +175°C)
WA	Fully encapsulated constantan gages with high-endurance leadwires.	±2%	-100° to +400°F (-75° to +205°C)
WK	Fully encapsulated K-alloy gages with high-endurance leadwires.	±1.5%	-452° to +550°F (-269° to +290°C)
SA	Fully encapsulated constantan gages with solder dots.	±2%	-100° to +400°F (-75° to +205°C)
SK	Fully encapsulated K-alloy gages with solder dots.	±1.5%	-452° to +450°F (-269° to +230°C)
SD	Equivalent to WD Series, but with solder dots instead of leadwires.	±1.5%	-320° to +400°F (-195° to +205°C)
WD	Fully encapsulated isoelastic gages with high-endurance leadwires.	±1.5%	-320° to +500°F (-195° to +260°C)



Note 1: Insert desired S-T-C number in spaces marked XX.

Note 2: Tolerance is increased when Option W, E, SE, LE, or P is specified.

Note 3: Products with designations and options shown in **bold** are not RoHS compliant.

*Options available but not normally recommended. See Optional Features data sheet for details.

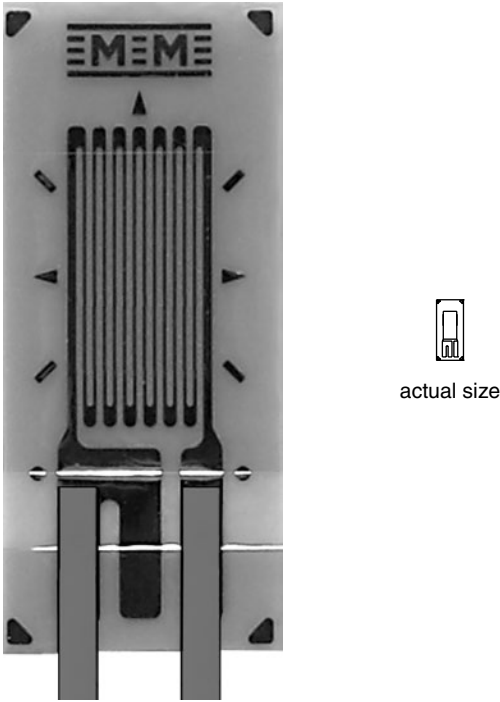
General Purpose Strain Gages – Linear Pattern

GAGE PATTERN DATA					
		GAGE DESIGNATION See Note 1	RESISTANCE (OHMS)	OPTIONS AVAILABLE	
		L2A-XX-125LW-120 L2A-XX-125LW-350 C2A-XX-125LW-120 C2A-XX-125LW-350	120 ± 0.6% 350 ± 0.6% 120 ± 0.6% 350 ± 0.6%		
		DESCRIPTION Widely used general-purpose gage.			
GAGE DIMENSIONS		Legend ES = Each Section CP = Complete Pattern S = Section (S1 = Section 1) M = Matrix			<input type="checkbox"/> inch <input type="checkbox"/> millimeter
Gage Length	Overall Length	Grid Width	Overall Width	Matrix Length	Matrix Width
0.125	0.238	0.070	0.080	0.315	0.170
3.18	6.05	1.78	2.03	8.00	4.32

GAGE SERIES DATA — See Gage Series datasheet for complete specifications			
Series	Description	Strain Range	Temperature Range
L2A	Encapsulated constantan gages with preattached ribbon leads.	±3%	-100° to +250°F (-75° to +120°C)
C2A	Encapsulated constantan gages with preattached ready-to-use cables.	±3%	-60° to +180°F (-50° to +80°C)



Example of an
L2A Construction



Example of an
C2A Construction

Note 1: Insert desired S-T-C number in spaces marked XX.

General Purpose Strain Gages – Linear Pattern

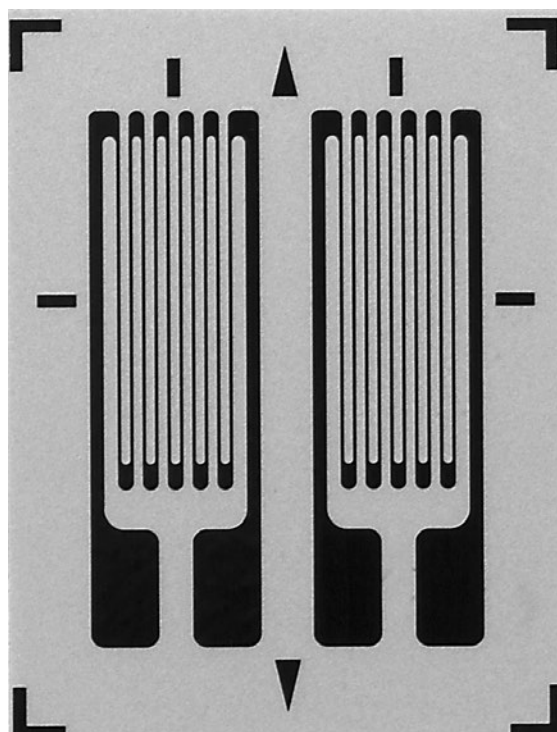
GAGE PATTERN DATA							
			GAGE DESIGNATION See Note 1, 3	RESISTANCE (OHMS) See Note 2	OPTIONS AVAILABLE See Note 3		
			EA-XX-125PC-120 EA-XX-125PC-350 ED-DY-125PC-350 ED-DY-125PC-10C EK-XX-125PC-10C WA-XX-125PC-120 WA-XX-125PC-350 WK-XX-125PC-350 WK-XX-125PC-10C SA-XX-125PC-120 SA-XX-125PC-350 SK-XX-125PC-350 SK-XX-125PC-10C	120 ± 0.2% 350 ± 0.2% 350 ± 0.4% 1000 ± 0.4% 1000 ± 0.2% 120 ± 0.4% 350 ± 0.4% 350 ± 0.4% 1000 ± 0.4% 1000 ± 0.4% 120 ± 0.4% 350 ± 0.4% 350 ± 0.4% 1000 ± 0.4%	W, E, L, LE W, E, L, LE E E W, SE W* W* W* W*		
DESCRIPTION Dual-pattern gage for use in back-to-back bending applications. Longitudinal grid centerlines spaced 0.085 in [2.16 mm] apart. See also 125MG pattern. EK-Series gages are supplied with duplex copper pads (DP) when optional W or SE is not specified.							
GAGE DIMENSIONS		Legend ES = Each Section CP = Complete Pattern S = Section (S1 = Section 1) M = Matrix					
					<table border="1"> <tr><td>inch</td></tr> <tr><td>millimeter</td></tr> </table>	inch	millimeter
inch							
millimeter							
Gage Length	Overall Length	Grid Width	Overall Width	Matrix Length	Matrix Width		
0.125 ES	0.205 CP	0.065 ES	0.150 CP	0.29	0.23		
3.18 ES	5.21 CP	1.65 ES	3.81 CP	7.4	5.8		

GAGE SERIES DATA — See Gage Series datasheet for complete specifications			
Series	Description	Strain Range	Temperature Range
EA	Constantan foil in combination with a tough, flexible, polyimide backing.	±5%	-100° to +350°F (-75° to +175°C)
ED	Isoelastic foil in combination with tough, flexible polyimide film.	±2%	-320° to +400°F (-195° to +205°C)
EK	K-alloy foil in combination with a tough, flexible polyimide backing.	±1.5%	-320° to +350°F (-195° to +175°C)
WA	Fully encapsulated constantan gages with high-endurance leadwires.	±2%	-100° to +400°F (-75° to +205°)
WK	Fully encapsulated K-alloy gages with high-endurance leadwires.	±1.5%	-452° to +550°F (-269° to +290°C)
SA	Fully encapsulated constantan gages with solder dots.	±2%	-100° to +400°F (-75° to +205°C)
SK	Fully encapsulated K-alloy gages with solder dots.	±1.5%	-452° to +450°F (-269° to +230°C)

Note 1: Insert desired S-T-C number in spaces marked XX.

Note 2: Tolerance is increased when Option W, E, SE, LE, or P is specified.

Note 3: Products with designations and options shown in **bold** are not RoHS compliant.

*Options available but not normally recommended. See Optional Features datasheet for details.

General Purpose Strain Gages – Linear Pattern

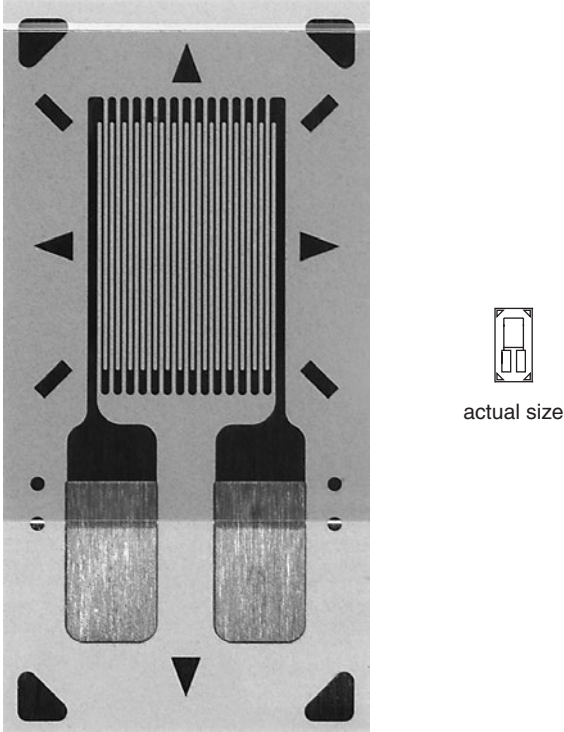
GAGE PATTERN DATA					
 <p>actual size</p>		GAGE DESIGNATION See Note 1	RESISTANCE (OHMS)	OPTIONS AVAILABLE See Note 2	
		CEA-XX-125UN-120 CEA-XX-125UN-350	120 ± 0.3% 350 ± 0.3%	P2 P2	
DESCRIPTION General-purpose gage with narrow geometry. Exposed solder tab area 0.06 x 0.05 in (1.5 x 1.1 mm). See also 125UW pattern.					
GAGE DIMENSIONS		Legend ES = Each Section CP = Complete Pattern S = Section (S1 = Section 1) M = Matrix			
				inch	
				millimeter	
Gage Length	Overall Length	Grid Width	Overall Width	Matrix Length	Matrix Width
0.125	0.275	0.100	0.120	0.38	0.19
3.18	6.99	2.54	3.05	9.7	4.8

GAGE SERIES DATA — See Gage Series datasheet for complete specifications			
Series	Description	Strain Range	Temperature Range
CEA	Universal general-purpose strain gages.	±5%	-100° to +350°F (-75° to +175°C)

Note 1: Insert desired S-T-C number in spaces marked XX.

Note 2: Products with designations and options shown in bold are not RoHS compliant.

General Purpose Strain Gages – Linear Pattern

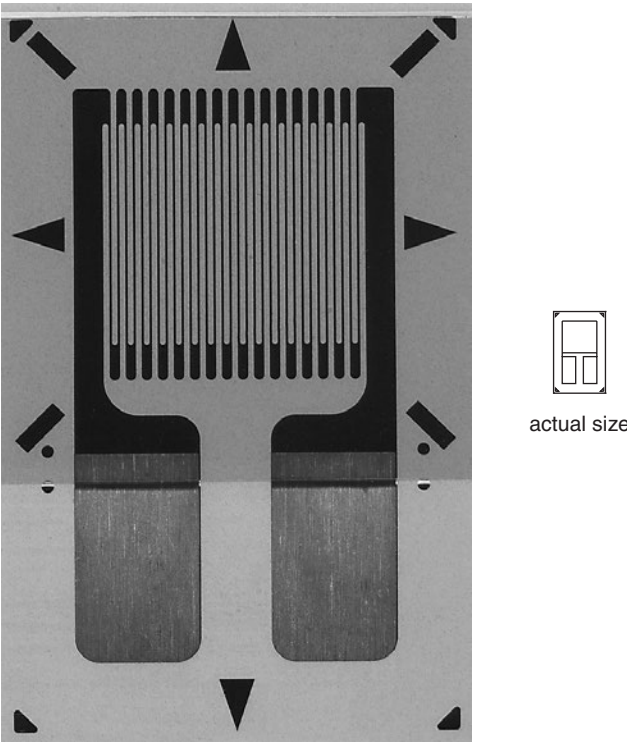
GAGE PATTERN DATA					
			GAGE DESIGNATION See Note 1	RESISTANCE (OHMS)	OPTIONS AVAILABLE See Note 2
			CEA-XX-125UW-120 CEA-XX-125UW-350	120 ± 0.3% 350 ± 0.3%	P2 P2
DESCRIPTION General-purpose gage. Exposed solder tab area 0.10 x 0.07 (2.5 x 1.8 mm). See also 125UN pattern.					
GAGE DIMENSIONS			Legend ES = Each Section CP = Complete Pattern S = Section (S1 = Section 1) M = Matrix		
			<input type="checkbox"/> inch <input type="checkbox"/> millimeter		
Gage Length	Overall Length	Grid Width	Overall Width	Matrix Length	Matrix Width
0.125	0.325	0.180	0.180	0.42	0.27
3.18	8.26	4.57	4.57	10.7	6.9

GAGE SERIES DATA — See Gage Series datasheet for complete specifications			
Series	Description	Strain Range	Temperature Range
CEA	Universal general-purpose strain gages.	±5%	-100° to +350°F (-75° to +175°C)

Note 1: Insert desired S-T-C number in spaces marked XX.

Note 2: Products with designations and options shown in bold are not RoHS compliant.

General Purpose Strain Gages—Linear Pattern

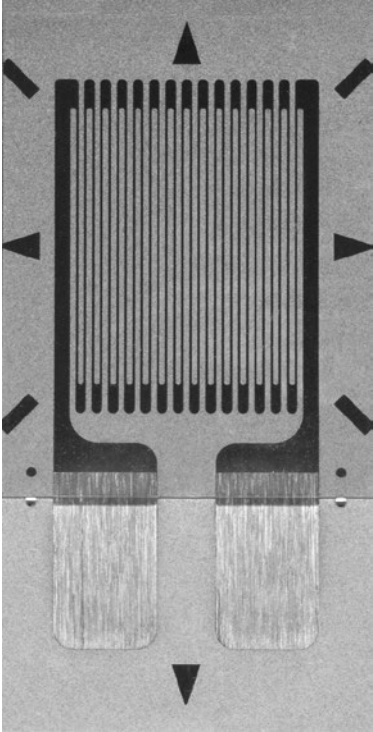
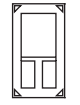
GAGE PATTERN DATA							
		 actual size		GAGE DESIGNATION See Note 1	RESISTANCE (OHMS)	OPTIONS AVAILABLE See Note 2	
				CEA-XX-187UW-120 CEA-XX-187UW-350	120 ± 0.3% 350 ± 0.3%	P2 P2	
DESCRIPTION General-purpose gage. Exposed solder tab area 0.10 x 0.07 in (2.5 x 1.8 mm).							
GAGE DIMENSIONS			Legend ES = Each Section CP = Complete Pattern S = Section (S1 = Section 1) M = Matrix				
			<table border="1"> <tr><td>inch</td></tr> <tr><td>millimeter</td></tr> </table>			inch	millimeter
inch							
millimeter							
Gage Length	Overall Length	Grid Width	Overall Width	Matrix Length	Matrix Width		
0.187	0.387	0.180	0.180	0.49	0.27		
4.75	9.83	4.57	4.57	12.4	6.9		

GAGE SERIES DATA — See Gage Series datasheet for complete specifications			
Series	Description	Strain Range	Temperature Range
CEA	Universal general-purpose strain gages.	±5%	-100° to +350°F (-75° to +175°C)

Note 1: Insert desired S-T-C number in spaces marked XX.

Note 2: Products with designations and options shown in **bold** are not RoHS compliant.

General Purpose Strain Gages – Linear Pattern

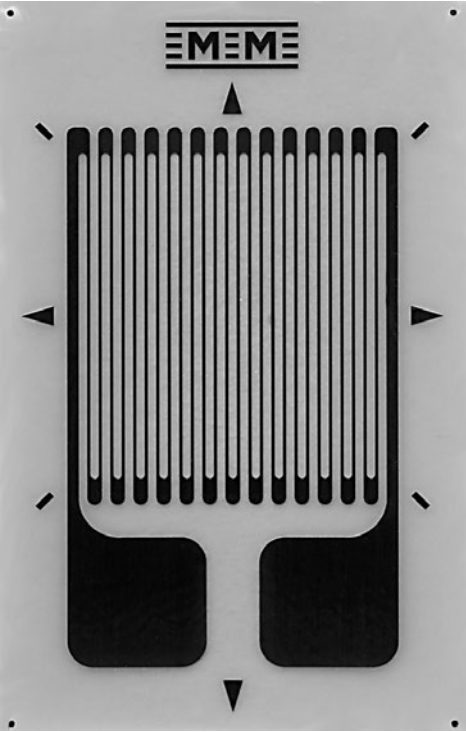
GAGE PATTERN DATA							
		GAGE DESIGNATION See Note 1, 3	RESISTANCE (OHMS) See Note 2	OPTIONS AVAILABLE See Note 3			
		EA-XX-250AE-350 ED-DY-250AE-10C WA-XX-250AE-350 WK-XX-250AE-10C EP-08-250AE-350 SA-XX-250AE-350 SK-XX-250AE-10C SD-DY-250AE-10C WD-DY-250AE-10C	350 ± 0.15% 1000 ± 0.3% 350 ± 0.3% 1000 ± 0.3% 350 ± 0.15% 350 ± 0.3% 1000 ± 0.3% 1000 ± 0.6% 1000 ± 0.6%	W, E, L, LE, P E, L ⁺ , LE ⁺ W* W*			
DESCRIPTION General-purpose gage with high-dissipation grid. See also 250AF pattern.							
GAGE DIMENSIONS		Legend ES = Each Section S = Section (S1 = Section 1)			<table border="1"> <tr><td>inch</td></tr> <tr><td>millimeter</td></tr> </table>	inch	millimeter
inch							
millimeter							
Gage Length	Overall Length	Grid Width	Overall Width	Matrix Length	Matrix Width		
0.250	0.415	0.250	0.250	0.57	0.36		
6.35	10.54	6.35	6.35	14.5	9.1		

GAGE SERIES DATA — See Gage Series datasheet for complete specifications			
Series	Description	Strain Range	Temperature Range
EA	Constantan foil in combination with a tough, flexible, polyimide backing.	±5%	-100° to +350°F (-75° to +175°C)
ED	Isoelastic foil in combination with tough, flexible polyimide film.	±2%	-320° to +400°F (-195° to +205°C)
WA	Fully encapsulated constantan gages with high-endurance leadwires.	±2%	-100° to +400°F (-75° to +205°)
WK	Fully encapsulated K-alloy gages with high-endurance leadwires.	±1.5%	-452° to +550°F (-269° to +290°C)
EP	Annealed constantan foil with tough, high-elongation polyimide backing.	±20%	-100° to +400°F (-75° to +205°C)
SA	Fully encapsulated constantan gages with solder dots.	±2%	-100° to +400°F (-75° to +205°C)
SK	Fully encapsulated K-alloy gages with solder dots.	±1.5%	-452° to +450°F (-269° to +230°C)
SD	Equivalent to WD Series, but with solder dots instead of leadwires.	±1.5%	-320° to +400°F (-195° to +205°C)
WD	Fully encapsulated isoelastic gages with high-endurance leadwires.	±1.5%	-320° to +500°F (-195° to +260°C)

Note 1: Insert desired S-T-C number in spaces marked XX.

Note 2: Tolerance is increased when Option W, E, SE, LE, or P is specified.

Note 3: Products with designations and options shown in **bold** are not RoHS compliant.

*Options available but not normally recommended. See Optional Features datasheet for details.

General Purpose Strain Gages—Linear Pattern

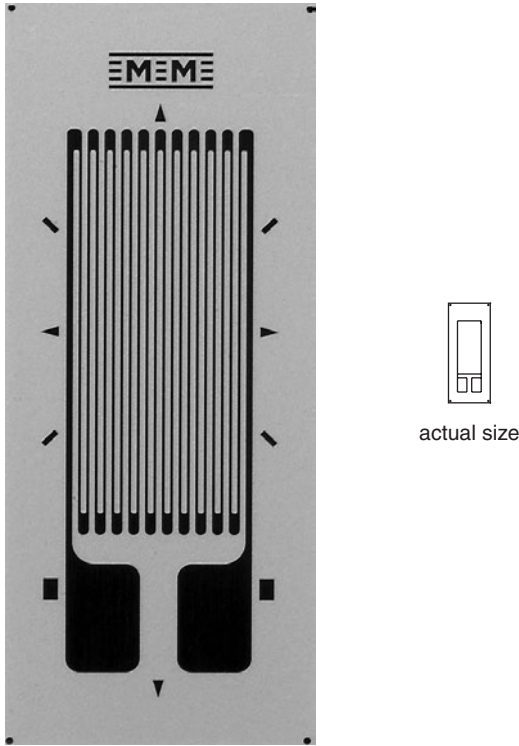
GAGE PATTERN DATA								
		GAGE DESIGNATION See Note 1, 3	RESISTANCE (OHMS) See Note 2	OPTIONS AVAILABLE See Note 3				
		EA-XX-250BF-350 ED-DY-250BF-10C EK-XX-250BF-10C S2K-XX-250BF-10C WA-XX-250BF-350 WK-XX-250BF-10C EP-08-250BF-350 SA-XX-250BF-350 SK-XX-250BF-10C SD-DY-250BF-10C WD-DY-250BF-10C	350 ± 0.15% 1000 ± 0.3% 1000 ± 0.15% 1000 ± 0.3% 350 ± 0.3% 1000 ± 0.3% 350 ± 0.15% 350 ± 0.3% 1000 ± 0.3% 1000 ± 0.6% 1000 ± 0.6%	W, E, L, LE, P E, L*, LE* W, SE W*				
DESCRIPTION General-purpose gage with high-resistance grid. Compact geometry. Similar to 250BG pattern except for resistance. See also 250BM and 250UW patterns. EK-Series gages are supplied with duplex copper pads (DP) when optional feature W or SE is not specified.								
GAGE DIMENSIONS		Legend ES = Each Section S = Section (S1 = Section 1)			CP = Complete Pattern M = Matrix	<table border="1"> <tr> <td>inch</td> </tr> <tr> <td>millimeter</td> </tr> </table>	inch	millimeter
inch								
millimeter								
Gage Length	Overall Length	Grid Width	Overall Width	Matrix Length	Matrix Width			
0.250	0.375	0.125	0.125	0.52	0.22			
6.35	9.53	3.18	3.18	13.2	5.6			

GAGE SERIES DATA — See Gage Series datasheet for complete specifications			
Series	Description	Strain Range	Temperature Range
EA	Constantan foil in combination with a tough, flexible, polyimide backing.	±5%	-100° to +350°F (-75° to +175°C)
ED	Isoelastic foil in combination with tough, flexible polyimide film.	±2%	-320° to +400°F (-195° to +205°C)
EK	K-alloy foil in combination with a tough, flexible polyimide backing.	±1.5%	-320° to +350°F (-195° to +175°C)
S2K	K-alloy foil with laminated thick, high-performance polyimide backing.	±1.5%	-100° to +250°F (-75° to +120°C)
WA	Fully encapsulated constantan gages with high-endurance leadwires.	±2%	-100° to +400°F (-75° to +205°)
WK	Fully encapsulated K-alloy gages with high-endurance leadwires.	±1.5%	-452° to +550°F (-269° to +290°C)
EP	Annealed constantan foil with tough, high-elongation polyimide backing.	±20%	-100° to +400°F (-75° to +205°C)
SA	Fully encapsulated constantan gages with solder dots.	±2%	-100° to +400°F (-75° to +205°C)
SK	Fully encapsulated K-alloy gages with solder dots.	±1.5%	-452° to +450°F (-269° to +230°C)
SD	Equivalent to WD Series, but with solder dots instead of leadwires.	±1.5%	-320° to +400°F (-195° to +205°C)
WD	Fully encapsulated isoelastic gages with high-endurance leadwires.	±1.5%	-320° to +500°F (-195° to +260°C)

Note 1: Insert desired S-T-C number in spaces marked XX.

Note 2: Tolerance is increased when Option W, E, SE, LE, or P is specified.

Note 3: Products with designations and options shown in **bold** are not RoHS compliant.

*Options available but not normally recommended. See Optional Features datasheet for details.

General Purpose Strain Gages—Linear Pattern

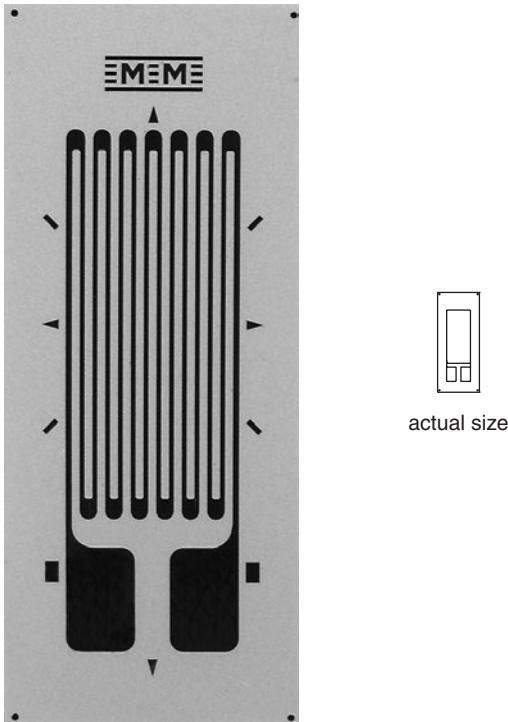
GAGE PATTERN DATA					
			GAGE DESIGNATION See Note 1, 3	RESISTANCE (OHMS) See Note 2	OPTIONS AVAILABLE See Note 3
			EA-XX-250BG-120 ED-DY-250BG-350 WA-XX-250BG-120 WK-XX-250BG-350 EP-XX-250BG-120 SA-XX-250BG-120 SK-XX-250BG-350 SD-DY-250BG-350 WD-DY-250BG-350	120 ± 0.15% 350 ± 0.3% 120 ± 0.3% 350 ± 0.3% 120 ± 0.15% 120 ± 0.3% 350 ± 0.3% 350 ± 0.6% 350 ± 0.6%	W, E, L, LE, P E, L*, LE* W* W*
DESCRIPTION Widely used general-purpose gage. Compact geometry. See also 250UN pattern.					
GAGE DIMENSIONS		Legend ES = Each Section CP = Complete Pattern S = Section (S1 = Section 1) M = Matrix			
				inch	
				millimeter	
Gage Length	Overall Length	Grid Width	Overall Width	Matrix Length	Matrix Width
0.250	0.375	0.125	0.125	0.52	0.22
6.35	9.53	3.18	3.18	13.2	5.6

GAGE SERIES DATA — See Gage Series datasheet for complete specifications			
Series	Description	Strain Range	Temperature Range
EA	Constantan foil in combination with a tough, flexible, polyimide backing.	±5%	-100° to +350°F (-75° to +175°C)
ED	Isoelastic foil in combination with tough, flexible polyimide film.	±2%	-320° to +400°F (-195° to +205°C)
WA	Fully encapsulated constantan gages with high-endurance leadwires.	±2%	-100° to +400°F (-75° to +205°)
WK	Fully encapsulated K-alloy gages with high-endurance leadwires.	±1.5%	-452° to +550°F (-269° to +290°C)
EP	Annealed constantan foil with tough, high-elongation polyimide backing.	±20%	-100° to +400°F (-75° to +205°C)
SA	Fully encapsulated constantan gages with solder dots.	±2%	-100° to +400°F (-75° to +205°C)
SK	Fully encapsulated K-alloy gages with solder dots.	±1.5%	-452° to +450°F (-269° to +230°C)
SD	Equivalent to WD Series, but with solder dots instead of leadwires.	±1.5%	-320° to +400°F (-195° to +205°C)
WD	Fully encapsulated isoelastic gages with high-endurance leadwires.	±1.5%	-320° to +500°F (-195° to +260°C)

Note 1: Insert desired S-T-C number in spaces marked XX.

Note 2: Tolerance is increased when Option W, E, SE, LE, or P is specified.

Note 3: Products with designations and options shown in **bold** are not RoHS compliant.

*Options available but not normally recommended. See Optional Features datasheet for details.

General Purpose Strain Gages – Linear Pattern

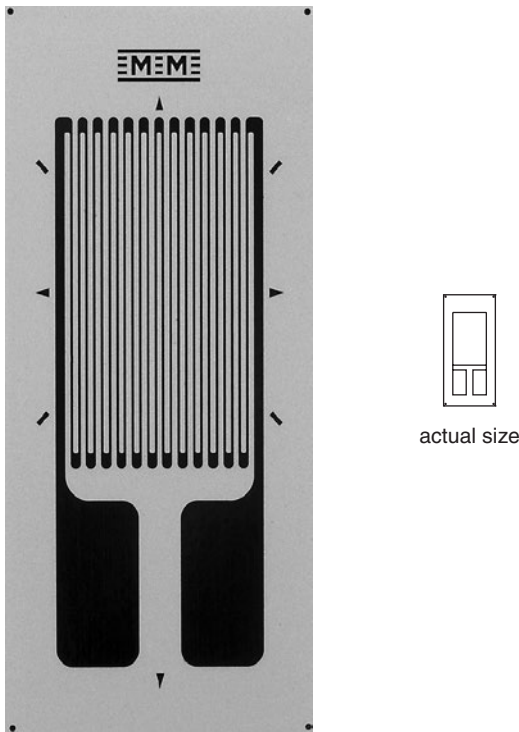
GAGE PATTERN DATA					
		GAGE DESIGNATION See Note 1, 3	RESISTANCE (OHMS) See Note 2	OPTIONS AVAILABLE See Note 3	
		EA-XX-250BK-10C WA-XX-250BK-10C WK-XX-250BK-30C SA-XX-250BK-10C SK-XX-250BK-30C	1000 ± 0.15% 1000 ± 0.3% 3000 ± 0.3% 1000 ± 0.3% 3000 ± 0.3%	W, E, L, LE, P W* W*	
DESCRIPTION High-resistance gage with good power dissipation capability for high-output applications or use on plastics.					
GAGE DIMENSIONS		Legend ES = Each Section CP = Complete Pattern S = Section (S1 = Section 1) M = Matrix			
				<input type="checkbox"/> inch <input type="checkbox"/> millimeter	
Gage Length	Overall Length	Grid Width	Overall Width	Matrix Length	Matrix Width
0.250	0.430	0.175	0.175	0.58	0.27
6.35	10.92	4.45	4.45	14.7	6.9

GAGE SERIES DATA — See Gage Series datasheet for complete specifications			
Series	Description	Strain Range	Temperature Range
EA	Constantan foil in combination with a tough, flexible, polyimide backing.	±5%	-100° to +350°F (-75° to +175°C)
WA	Fully encapsulated constantan gages with high-endurance leadwires.	±2%	-100° to +400°F (-75° to +205°)
WK	Fully encapsulated K-alloy gages with high-endurance leadwires.	±1.5%	-452° to +550°F (-269° to +290°C)
SA	Fully encapsulated constantan gages with solder dots.	±2%	-100° to +400°F (-75° to +205°C)
SK	Fully encapsulated K-alloy gages with solder dots.	±1.5%	-452° to +450°F (-269° to +230°C)



Note 1: Insert desired S-T-C number in spaces marked XX.

Note 2: Tolerance is increased when Option W, E, SE, LE, or P is specified.

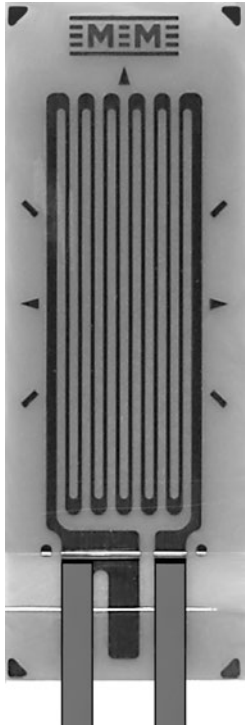

Note 3: Products with designations and options shown in **bold** are not RoHS compliant.

*Options available but not normally recommended. See Optional Features datasheet for details.

General Purpose Strain Gages – Linear Pattern

GAGE PATTERN DATA					
		GAGE DESIGNATION See Note 1		RESISTANCE (OHMS)	OPTIONS AVAILABLE
		L2A-XX-250LW-120 L2A-XX-250LW-350 C2A-XX-250LW-120 C2A-XX-250LW-350		120 ± 0.6% 350 ± 0.6% 120 ± 0.6% 350 ± 0.6%	
		 actual size			
DESCRIPTION Widely used general-purpose gage.				 RoHS COMPLIANT	
GAGE DIMENSIONS		Legend ES = Each Section S = Section (S1 = Section 1)			<input type="checkbox"/> inch <input type="checkbox"/> millimeter
		CP = Complete Pattern M = Matrix			
Gage Length	Overall Length	Grid Width	Overall Width	Matrix Length	Matrix Width
0.250	0.363	0.100	0.100	0.440	0.170
6.35	9.22	2.54	2.54	11.18	4.32

GAGE SERIES DATA — See Gage Series datasheet for complete specifications			
Series	Description	Strain Range	Temperature Range
L2A	Encapsulated constantan gages with preattached ribbon leads.	±3%	-100° to +250°F (-75° to +120°C)
C2A	Encapsulated constantan gages with preattached ready-to-use cables.	±3%	-60° to +180°F (-50° to +80°C)

 Example of an L2A Construction	 Example of a C2A Construction
--	--

Note 1: Insert desired S-T-C number in spaces marked XX.

General Purpose Strain Gages—Linear Pattern

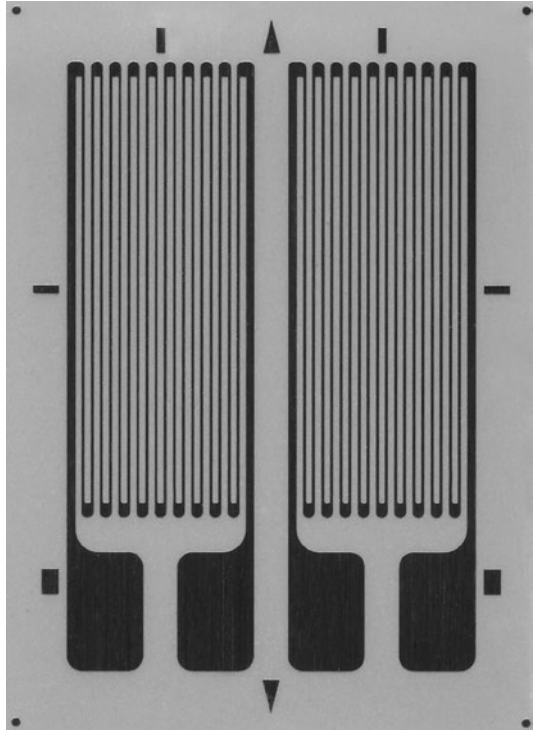
GAGE PATTERN DATA					
 <p style="text-align: center;">actual size</p>			GAGE DESIGNATION See Note 1, 3	RESISTANCE (OHMS) See Note 2	OPTIONS AVAILABLE See Note 3
			EA-XX-250PD-120 EA-XX-250PD-350 ED-DY-250PD-350 EK-XX-250PD-10C S2K-XX-250PD-10C WA-XX-250PD-120 WA-XX-250PD-350 WK-XX-250PD-350 WK-XX-250PD-10C SA-XX-250PD-120 SA-XX-250PD-350 SK-XX-250PD-350 SK-XX-250PD-10C SD-DY-250PD-350 WD-DY-250PD-350	120 ± 0.2% 350 ± 0.2% 350 ± 0.4% 1000 ± 0.2% 1000 ± 0.4% 120 ± 0.3% 350 ± 0.3% 350 ± 0.4% 1000 ± 0.4% 120 ± 0.4% 350 ± 0.4% 350 ± 0.4% 1000 ± 0.4% 350 ± 0.8% 350 ± 0.8%	W, E, L, LE W, E, L, LE E W, SE W* W* W* W*
DESCRIPTION Dual-element pattern with longitudinal grid centerlines spaced 0.130 in [3.30 mm] apart. See also 250MQ pattern. EK-Series gages are supplied with duplex copper pads (DP) when optional feature W or SE is not specified.					
GAGE DIMENSIONS		Legend ES = Each Section CP = Complete Pattern S = Section (S1 = Section 1) M = Matrix			
				inch	
				millimeter	
Gage Length	Overall Length	Grid Width	Overall Width	Matrix Length	Matrix Width
0.250	0.358	0.110	0.240	0.44	0.32
6.35	9.09	2.79	6.10	11.2	8.1

GAGE SERIES DATA — See Gage Series datasheet for complete specifications			
Series	Description	Strain Range	Temperature Range
EA	Constantan foil in combination with a tough, flexible, polyimide backing.	±5%	-100° to +350°F (-75° to +175°C)
ED	Isoelastic foil in combination with tough, flexible polyimide film.	±2%	-320° to +400°F (-195° to +205°C)
EK	K-alloy foil in combination with a tough, flexible polyimide backing.	±1.5%	-320° to +350°F (-195° to +175°C)
S2K	K-alloy foil with laminated thick, high-performance polyimide backing.	±1.5%	-100° to +250°F (-75° to +120°C)
WA	Fully encapsulated constantan gages with high-endurance leadwires.	±2%	-100° to +400°F (-75° to +205°)
WK	Fully encapsulated K-alloy gages with high-endurance leadwires.	±1.5%	-452° to +550°F (-269° to +290°C)
SA	Fully encapsulated constantan gages with solder dots.	±2%	-100° to +400°F (-75° to +205°C)
SK	Fully encapsulated K-alloy gages with solder dots.	±1.5%	-452° to +450°F (-269° to +230°C)
SD	Equivalent to WD Series, but with solder dots instead of leadwires.	±1.5%	-320° to +400°F (-195° to +205°C)
WD	Fully encapsulated isoelastic gages with high-endurance leadwires.	±1.5%	-320° to +500°F (-195° to +260°C)

Note 1: Insert desired S-T-C number in spaces marked XX.

Note 2: Tolerance is increased when Option W, E, SE, LE, or P is specified.

Note 3: Products with designations and options shown in **bold** are not RoHS compliant.

*Options available but not normally recommended. See Optional Features datasheet for details.

General Purpose Strain Gages – Linear Pattern

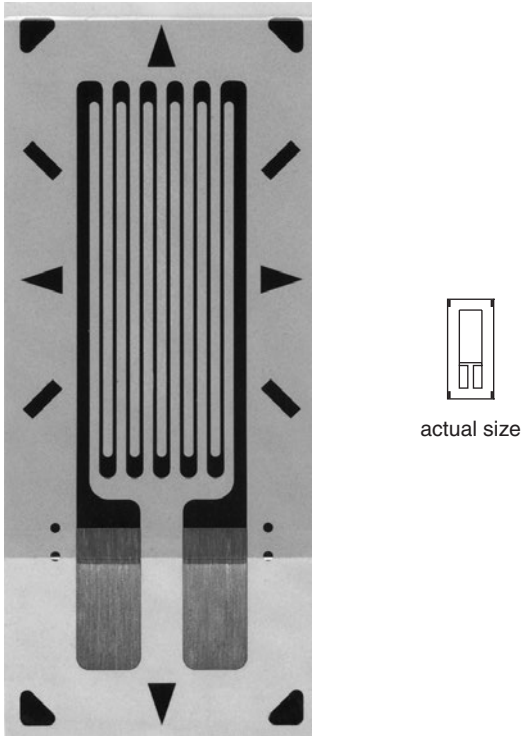
GAGE PATTERN DATA					
		GAGE DESIGNATION See Note 1	RESISTANCE (OHMS)	OPTIONS AVAILABLE See Note 2	
		CEA-XX-250UN-120 CEA-XX-250UN-350	120 ± 0.3% 350 ± 0.3%	P2 P2	
DESCRIPTION General-purpose gage with narrow geometry. Exposed solder tab area 0.08 x 0.05 in (2.0 x 1.1 mm). See also 250UW pattern.					
GAGE DIMENSIONS		Legend ES = Each Section CP = Complete Pattern S = Section (S1 = Section 1) M = Matrix			<input type="checkbox"/> inch <input type="checkbox"/> millimeter
Gage Length	Overall Length	Grid Width	Overall Width	Matrix Length	Matrix Width
0.250	0.415	0.120	0.120	0.52	0.22
6.35	10.54	3.05	3.05	13.2	5.6

GAGE SERIES DATA — See Gage Series datasheet for complete specifications			
Series	Description	Strain Range	Temperature Range
CEA	Universal general-purpose strain gages.	±5%	-100° to +350°F (-75° to +175°C)

Note 1: Insert desired S-T-C number in spaces marked XX.

Note 2: Products with designations and options shown in **bold** are not RoHS compliant.

General Purpose Strain Gages – Linear Pattern

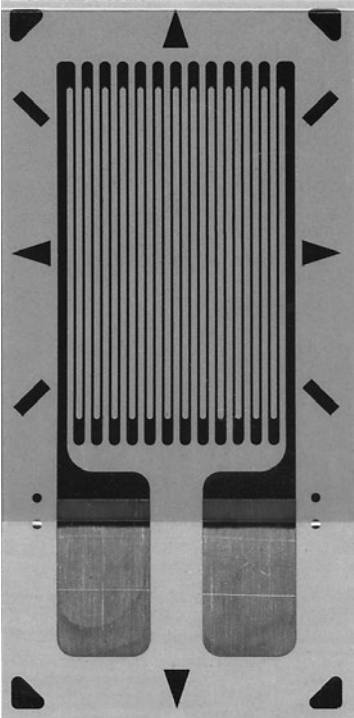
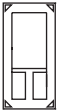
GAGE PATTERN DATA							
				<p>GAGE DESIGNATION See Note 1</p>			
		<p>RESISTANCE (OHMS)</p>		<p>OPTIONS AVAILABLE See Note 2</p>			
		<p>CEA-XX-250UW-120 CEA-XX-250UW-175 CEA-XX-250UW-350 CEA-XX-250UW-10C</p>		<p>120 ± 0.3% 175 ± 0.3% 350 ± 0.3% 1000 ± 0.3%</p>			
		<p>actual size</p>		<p>DESCRIPTION General-purpose gage. Exposed solder tab area 0.10 x 0.07 in (2.5 x 1.8 mm). See also 250UN pattern.</p>			
<p>GAGE DIMENSIONS</p>			<p>Legend ES = Each Section CP = Complete Pattern S = Section (S1 = Section 1) M = Matrix</p>				
			<table border="1"> <tr> <td>inch</td> </tr> <tr> <td>millimeter</td> </tr> </table>			inch	millimeter
inch							
millimeter							
Gage Length	Overall Length	Grid Width	Overall Width	Matrix Length	Matrix Width		
0.250	0.450	0.180	0.180	0.55	0.27		
6.35	11.43	4.57	4.57	14.0	6.9		

GAGE SERIES DATA — See Gage Series datasheet for complete specifications			
Series	Description	Strain Range	Temperature Range
CEA	Universal general-purpose strain gages.	±5%	-100° to +350°F (-75° to +175°C)

Note 1: Insert desired S-T-C number in spaces marked XX.

Note 2: Products with designations and options shown in **bold** are not RoHS compliant.

General Purpose Strain Gages – Linear Pattern

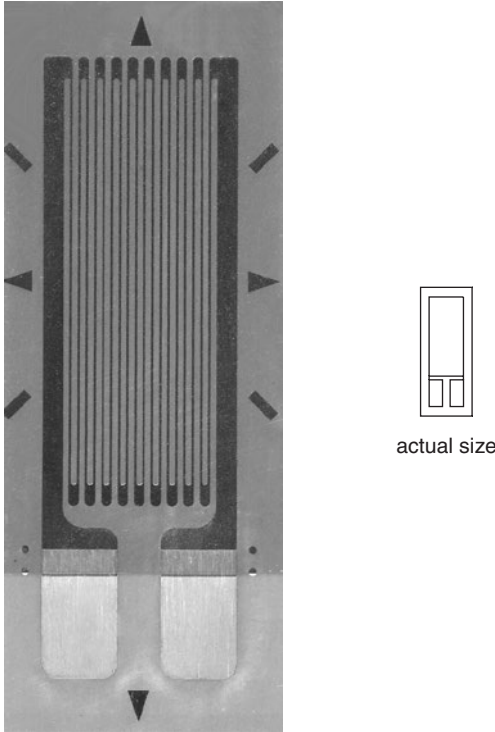
GAGE PATTERN DATA					
		GAGE DESIGNATION See Note 1	RESISTANCE (OHMS)	OPTIONS AVAILABLE See Note 2	
		CEA-XX-375UW-120 CEA-XX-375UW-350	120 ± 0.3% 350 ± 0.3%	P2 P2	
DESCRIPTION General-purpose gage. Exposed solder tab area 0.10 x 0.07 in (2.5 x 1.8 mm).					
GAGE DIMENSIONS		Legend ES = Each Section S = Section (S1 = Section 1) CP = Complete Pattern M = Matrix			<input type="checkbox"/> inch <input type="checkbox"/> millimeter
Gage Length	Overall Length	Grid Width	Overall Width	Matrix Length	Matrix Width
0.375	0.575	0.180	0.180	0.67	0.27
9.53	14.61	4.57	4.57	17.0	6.9

GAGE SERIES DATA — See Gage Series datasheet for complete specifications			
Series	Description	Strain Range	Temperature Range
CEA	Universal general-purpose strain gages.	±5%	-100° to +350°F (-75° to +175°C)

Note 1: Insert desired S-T-C number in spaces marked XX.

Note 2: Products with designations and options shown in **bold** are not RoHS compliant.

General Purpose Strain Gages – Linear Pattern

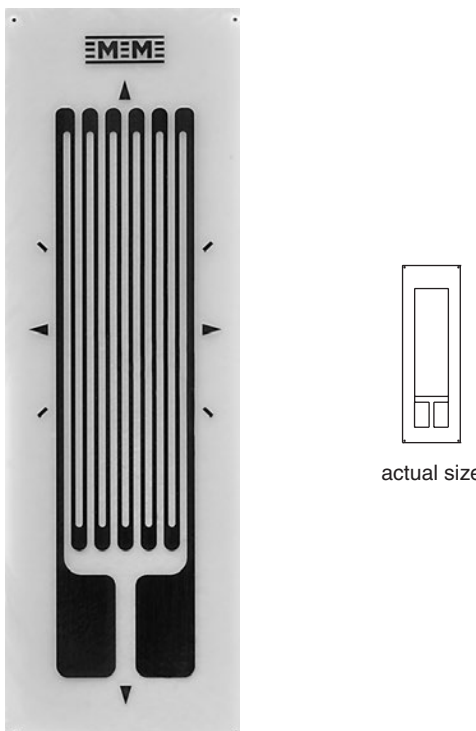
GAGE PATTERN DATA							
 <p>actual size</p>		GAGE DESIGNATION See Note 1, 3	RESISTANCE (OHMS) See Note 2	OPTIONS AVAILABLE See Note 3			
		EA-XX-500BH-120 ED-DY-500BH-350 WA-XX-500BH-120 WK-XX-500BH-350 EP-08-500BH-120 SA-XX-500BH-120 SK-XX-500BH-350 SD-DY-500BH-350 WD-DY-500BH-350	120 ± 0.15% 350 ± 0.3% 120 ± 0.3% 350 ± 0.3% 120 ± 0.15% 120 ± 0.3% 350 ± 0.3% 350 ± 0.6% 350 ± 0.6%	W, E, L, LE, P E, L*, LE* W* W*			
DESCRIPTION Widely used general-purpose gage with compact geometry. See also 500BL and 500UW patterns.							
GAGE DIMENSIONS		Legend ES = Each Section CP = Complete Pattern S = Section (S1 = Section 1) M = Matrix					
				<table border="1"> <tr><td>inch</td></tr> <tr><td>millimeter</td></tr> </table>	inch	millimeter	
inch							
millimeter							
Gage Length	Overall Length	Grid Width	Overall Width	Matrix Length	Matrix Width		
0.500	0.720	0.175	0.175	0.92	0.30		
12.70	18.29	4.45	4.45	23.4	7.6		

GAGE SERIES DATA — See Gage Series datasheet for complete specifications			
Series	Description	Strain Range	Temperature Range
EA	Constantan foil in combination with a tough, flexible, polyimide backing.	±5%	-100° to +350°F (-75° to +175°C)
ED	Isoelastic foil in combination with tough, flexible polyimide film.	±2%	-320° to +400°F (-195° to +205°C)
WA	Fully encapsulated constantan gages with high-endurance leadwires.	±2%	-100° to +400°F (-75° to +205°)
WK	Fully encapsulated K-alloy gages with high-endurance leadwires.	±1.5%	-452° to +550°F (-269° to +290°C)
EP	Annealed constantan foil with tough, high-elongation polyimide backing.	±20%	-100° to +400°F (-75° to +205°C)
SA	Fully encapsulated constantan gages with solder dots.	±2%	-100° to +400°F (-75° to +205°C)
SK	Fully encapsulated K-alloy gages with solder dots.	±1.5%	-452° to +450°F (-269° to +230°C)
SD	Equivalent to WD Series, but with solder dots instead of leadwires.	±1.5%	-320° to +400°F (-195° to +205°C)
WD	Fully encapsulated isoelastic gages with high-endurance leadwires.	±1.5%	-320° to +500°F (-195° to +260°C)



Note 1: Insert desired S-T-C number in spaces marked XX.

Note 2: Tolerance is increased when Option W, E, SE, LE, or P is specified.

Note 3: Products with designations and options shown in **bold** are not RoHS compliant.

*Options available but not normally recommended. See Optional Features datasheet for details.

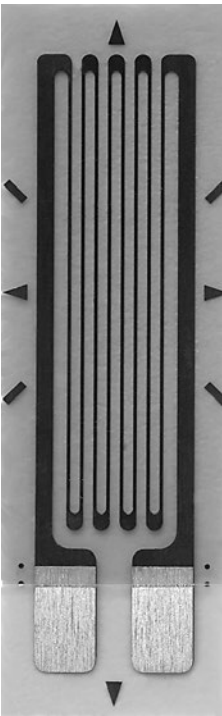
General Purpose Strain Gages – Linear Pattern

GAGE PATTERN DATA							
		<p>GAGE DESIGNATION See Note 1</p>		<p>RESISTANCE (OHMS)</p>	<p>OPTIONS AVAILABLE See Note 2</p>		
		<p>CEA-XX-500UW-120 CEA-XX-500UW-350</p>		<p>120 ± 0.3% 350 ± 0.3%</p>	<p>P2 P2</p>		
 <p>actual size</p>		<p>DESCRIPTION</p> <p>General-purpose gage. Exposed solder tab area 0.10 x 0.07 in (2.5 x 1.8 mm).</p>					
		<p>GAGE DIMENSIONS</p>					
			<p>Legend</p> <p>ES = Each Section CP = Complete Pattern S = Section (S1 = Section 1) M = Matrix</p>		<table border="1"> <tr><td>inch</td></tr> <tr><td>millimeter</td></tr> </table>	inch	millimeter
inch							
millimeter							
Gage Length	Overall Length	Grid Width	Overall Width	Matrix Length	Matrix Width		
0.500	0.700	0.180	0.180	0.80	0.27		
12.70	17.78	4.57	4.57	20.3	6.9		

GAGE SERIES DATA — See Gage Series datasheet for complete specifications

Series	Description	Strain Range	Temperature Range
CEA	Universal general-purpose strain gages.	±5%	-100° to +350°F (-75° to +175°C)

Note 1: Insert desired S-T-C number in spaces marked XX.

Note 2: Tolerance is increased when Option W, E, SE, LE, or P is specified.

General Purpose Strain Gages – Linear Pattern

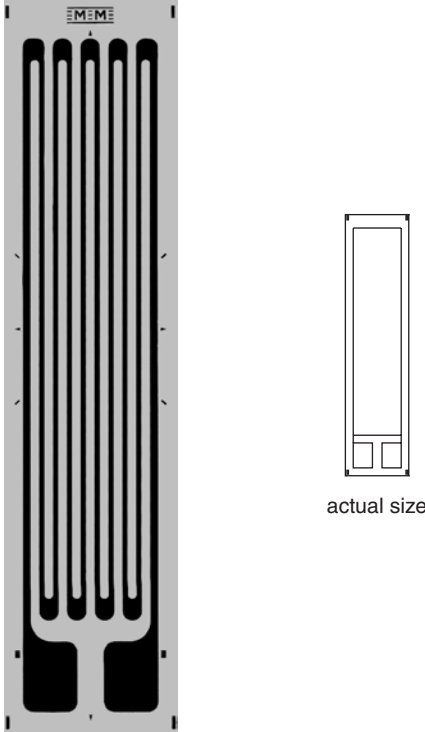
GAGE PATTERN DATA					
		GAGE DESIGNATION See Note 1, 3	RESISTANCE (OHMS) See Note 2	OPTIONS AVAILABLE See Note 3	
		N2A-XX-10CBE-120 N2A-XX-10CBE-350 EA-XX-10CBE-120 WA-XX-10CBE-120 WK-XX-10CBE-350 EP-XX-10CBE-120 SA-XX-10CBE-120 SK-XX-10CBE-350	120 ± 0.15% 350 ± 0.15% 120 ± 0.15% 120 ± 0.3% 350 ± 0.3% 120 ± 0.15% 120 ± 0.3% 350 ± 0.3%	W, E, L, LE, P W, E, L, LE, P W, E, L, LE, P W* W*	
DESCRIPTION Large general-purpose gage.					
GAGE DIMENSIONS		Legend ES = Each Section CP = Complete Pattern S = Section (S1 = Section 1) M = Matrix			<input type="checkbox"/> inch <input type="checkbox"/> millimeter
Gage Length	Overall Length	Grid Width	Overall Width	Matrix Length	Matrix Width
1.000	1.250	0.250	0.250	1.36	0.33
25.40	31.75	6.35	6.35	34.5	8.4

GAGE SERIES DATA — See Gage Series datasheet for complete specifications			
Series	Description	Strain Range	Temperature Range
N2A	Constantan foil gages with a thin, laminated, polyimide-film backing.	±3%	-100° to +200°F (-75° to +95°C)
EA	Constantan foil in combination with a tough, flexible, polyimide backing.	±5%	-100° to +350°F (-75° to +175°C)
WA	Fully encapsulated constantan gages with high-endurance leadwires.	±2%	-100° to +400°F (-75° to +205°)
WK	Fully encapsulated K-alloy gages with high-endurance leadwires.	±1.5%	-452° to +550°F (-269° to +290°C)
EP	Annealed constantan foil with tough, high-elongation polyimide backing.	±20%	-100° to +400°F (-75° to +205°C)
SA	Fully encapsulated constantan gages with solder dots.	±2%	-100° to +400°F (-75° to +205°C)
SK	Fully encapsulated K-alloy gages with solder dots.	±1.5%	-452° to +450°F (-269° to +230°C)

Note 1: Insert desired S-T-C number in spaces marked XX.

Note 2: Tolerance is increased when Option W, E, SE, LE, or P is specified.

Note 3: Products with designations and options shown in **bold** are not RoHS compliant.

*Options available but not normally recommended. See Optional Features datasheet for details.

General Purpose Strain Gages – Linear Pattern

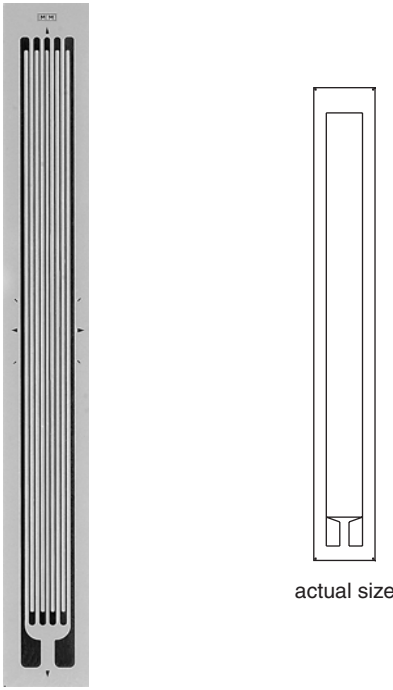
GAGE PATTERN DATA							
		GAGE DESIGNATION See Note 1, 3	RESISTANCE (OHMS) See Note 2	OPTIONS AVAILABLE See Note 3			
		N2A-XX-20CBW-120 N2A-XX-20CBW-350 EA-XX-20CBW-120 WA-XX-20CBW-120 WK-XX-20CBW-350 EP-XX-20CBW-120 SA-XX-20CBW-120 SK-XX-20CBW-350	120 ± 0.2% 350 ± 0.2% 120 ± 0.2% 350 ± 0.4% 120 ± 0.4% 350 ± 0.2% 120 ± 0.4% 350 ± 0.4%	W, E, L, LE, P W, E, L, LE, P W, E, L, LE, P W* W*			
DESCRIPTION For use on concrete and for strain integration on large specimens.							
GAGE DIMENSIONS		Legend			<table border="1"> <tr><td>inch</td></tr> <tr><td>millimeter</td></tr> </table>	inch	millimeter
inch							
millimeter							
		ES = Each Section	CP = Complete Pattern				
		S = Section (S1 = Section 1)	M = Matrix				
Gage Length	Overall Length	Grid Width	Overall Width	Matrix Length	Matrix Width		
2.000	2.250	0.188	0.188	2.46	0.32		
50.80	57.15	4.78	4.78	62.5	8.1		

GAGE SERIES DATA — See Gage Series datasheet for complete specifications			
Series	Description	Strain Range	Temperature Range
N2A	Constantan foil gages with a thin, laminated, polyimide-film backing.	±3%	-100° to +200°F (-75° to +95°C)
EA	Constantan foil in combination with a tough, flexible, polyimide backing.	±5%	-100° to +350°F (-75° to +175°C)
WA	Fully encapsulated constantan gages with high-endurance leadwires.	±2%	-100° to +400°F (-75° to +205°)
WK	Fully encapsulated K-alloy gages with high-endurance leadwires.	±1.5%	-452° to +550°F (-269° to +290°C)
EP	Annealed constantan foil with tough, high-elongation polyimide backing.	±20%	-100° to +400°F (-75° to +205°C)
SA	Fully encapsulated constantan gages with solder dots.	±2%	-100° to +400°F (-75° to +205°C)
SK	Fully encapsulated K-alloy gages with solder dots.	±1.5%	-452° to +450°F (-269° to +230°C)



Note 1: Insert desired S-T-C number in spaces marked XX.

Note 2: Tolerance is increased when Option W, E, SE, LE, or P is specified.

Note 3: Products with designations and options shown in **bold** are not RoHS compliant.

*Options available but not normally recommended. See Optional Features datasheet for details.

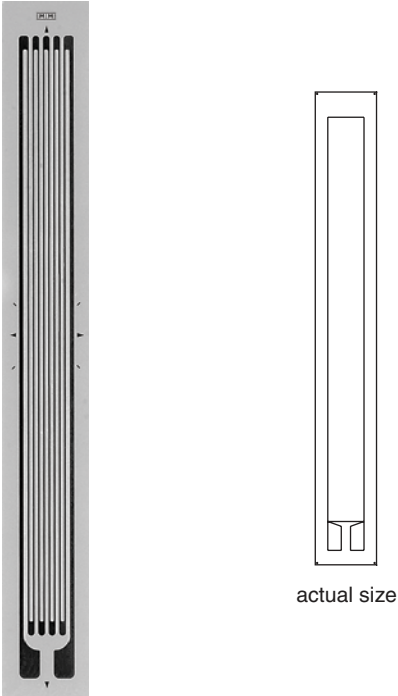









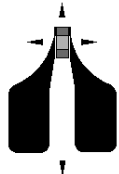

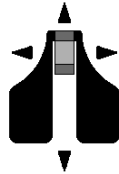
General Purpose Strain Gages – Linear Pattern

GAGE PATTERN DATA					
			GAGE DESIGNATION See Note 1	RESISTANCE (OHMS)	OPTIONS AVAILABLE
			C2A-XX-20CLW-120 C2A-XX-20CLW-350	120 ± 0.6% 350 ± 0.6%	
DESCRIPTION For use on concrete and for strain integration on large specimens.					
GAGE DIMENSIONS		Legend ES = Each Section CP = Complete Pattern S = Section (S1 = Section 1) M = Matrix			<input type="checkbox"/> inch <input type="checkbox"/> millimeter
Gage Length	Overall Length	Grid Width	Overall Width	Matrix Length	Matrix Width
2.000	2.155	0.175	0.175	2.232	0.235
50.80	54.740	4.450	4.450	56.692	5.969

GAGE SERIES DATA — See Gage Series datasheet for complete specifications			
Series	Description	Strain Range	Temperature Range
C2A	Encapsulated constantan gages with preattached ready-to-use cables.	±3%	-60° to +180°F (-50° to +80°C)
 Example of a C2A Construction			

Note 1: Insert desired S-T-C number in spaces marked XX.

General Purpose Strain Gages











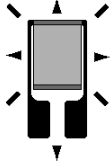

GAGE PATTERN	GAGE SERIES See Note 1	GAGE RESISTANCE (OHMS)	GAGE LENGTH	
			inches	millimeters
008CL   actual size	SA	120	0.008	0.2
	Micro-grid gage for strain measurement in high-gradient areas. Matrix size: 0.20L x 0.13W in. (5.1L x 3.3W mm)			
015CK   actual size	EA, WA, EP, SA	120	0.015	0.38
	Micro-miniature pattern with enlarged solder tabs. See also 015UW pattern. Matrix size: 0.19L x 0.15W in. (4.8L x 3.8W mm)			
015EH   actual size	EA, EP, SA, SK	120	0.015	0.38
	Micro-miniature pattern with tab at each side of grid. Matrix size: 0.15L x 0.19W in. (3.8L x 4.8W mm)			
015LA   actual size	EA, EP	120	0.015	0.38
	Primarily used in small radii where gage tabs must be at one end. Matrix size: 0.18L x 0.10W in. (4.6L x 2.5W mm)			
015SE   actual size	EA, EP, SA	120	0.015	0.38
	Micro-miniature pattern with tabs on one side for use near abutments. Matrix size: 0.16L x 0.14W in. (4.1L x 3.6W mm)			
030LB   actual size	EA, EP, SA	120	0.03	0.76
	Miniature gage pattern for small radii where gage tabs must be at one end. Matrix size: 0.24L x 0.15W in. (6.1L x 3.8W mm)			

Note 1: Products with designations and options shown in **bold** are not RoHS compliant.

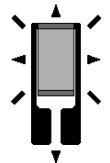
See www.micro-measurements.com/stress-analysis-strain-gages/other-linear-patterns/ for complete specifications of patterns listed.

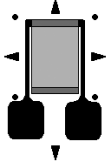
For all linear patterns offered, see www.micro-measurements.com/stress-analysis-strain-gages/all-linear-patterns/

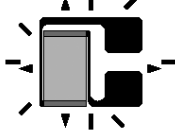
General Purpose Strain Gages











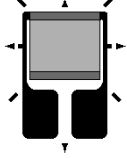

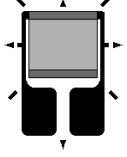
GAGE PATTERN	GAGE SERIES See Note 1	GAGE RESISTANCE (OHMS)	GAGE LENGTH	
			inches	millimeters
031MF   actual size	EA, SA	120	0.031	0.79
Miniature ten-element strip gage with electrically independent grids. All grids parallel to long axis of pattern. Grid centerline spacing 0.080 in (2.03 mm). Matrix size: 0.94L x 0.19W in. (23.9L x 4.8W mm)				
032SG   actual size	EA, WA, WK, EP, SA, SK	120	0.032	0.81
Miniature gage with side-tab geometry. Matrix size: 0.16L x 0.19W in. (4.1L x 4.8W mm)				
045AL   actual size	EA, SA	350	0.045	1.14
Miniature high-resistance gage. Matrix size: 0.22L x 0.14W in. (5.6L x 3.6W mm)				
050AH   actual size	EA, ED, EP, SA, SK, SD	120, 350	0.05	1.27
General-purpose miniature gage. Matrix size: 0.23L x 0.14W in. (5.8L x 3.6W mm)				
050AR   actual size	EA, ED, WA, WK, SA, SK, SD, WD	120, 350	0.05	1.27
General-purpose miniature gage with large solder tabs. Matrix size: 0.25L x 0.18W in. (6.4L x 4.6W mm)				
050SB   actual size	EA, ED, WA, WK, EP, SA, SK, SD, WD	120, 350	0.05	1.27
Similar to the 050AH pattern but with solder tabs at side of grid. Matrix size: 0.19L x 0.19W in. (4.8L x 4.8W mm)				

Note 1: Products with designations and options shown in **bold** are not RoHS compliant.

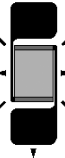
See www.micro-measurements.com/stress-analysis-strain-gages/other-linear-patterns/ for complete specifications of patterns listed.

For all linear patterns offered, see www.micro-measurements.com/stress-analysis-strain-gages/all-linear-patterns/

General Purpose Strain Gages











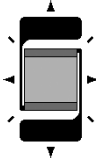

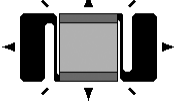
GAGE PATTERN	GAGE SERIES See Note 1	GAGE RESISTANCE (OHMS)	GAGE LENGTH	
			inches	millimeters
060CD   actual size	EA, ED, WA , WK, SA , SK , SD , WD	350, 1000	0.06	1.52
060CN   actual size	EA, ED, WA , WK, EP, SA , SD , WD	120, 350	0.06	1.52
060CP   actual size	EA, ED, WA , WK, EP, SA , SK , SD , WD	120, 350	0.06	1.52
062DF   actual size	EA, ED, WA , WK, EP, SA , SK , SD , WD	120, 350	0.062	1.57
070LC   actual size	EA	120, 350	0.07	1.78
090DG   actual size	EA, ED, EP, SA , SK , SD	120, 350	0.09	2.29

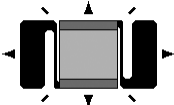
Note 1: Products with designations and options shown in **bold** are not RoHS compliant.

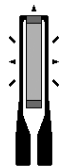
See www.micro-measurements.com/stress-analysis-strain-gages/other-linear-patterns/ for complete specifications of patterns listed.

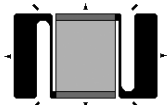
For all linear patterns offered, see www.micro-measurements.com/stress-analysis-strain-gages/all-linear-patterns/

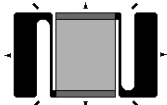
General Purpose Strain Gages







GAGE PATTERN	GAGE SERIES See Note 1	GAGE RESISTANCE (OHMS)	GAGE LENGTH	
			inches	millimeters
090DH   actual size	EA, ED, EP, SA, SK, SD	350, 1000	0.09	2.29
090EF   actual size	EA, ED, EP, SA, SK, SD	120, 350	0.09	2.29
090EG   actual size	EA, ED, EP, SA, SK, SD	350, 1000	0.09	2.29
125BS   actual size	ED, WK, SK, SD , WD	120	0.125	3.18
125EP   actual size	EA, ED, EP, SA, SK, SD	350, 1000	0.125	3.18
125EQ   actual size	EA, ED, EP, SA, SK, SD	120, 350	0.125	3.18

Note 1: Products with designations and options shown in **bold** are not RoHS compliant.

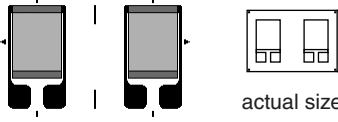
See www.micro-measurements.com/stress-analysis-strain-gages/other-linear-patterns/ for complete specifications of patterns listed.

For all linear patterns offered, see www.micro-measurements.com/stress-analysis-strain-gages/all-linear-patterns/

General Purpose Strain Gages





GAGE PATTERN	GAGE SERIES See Note 1	GAGE RESISTANCE (OHMS)	GAGE LENGTH	
			inches	millimeters
125MG  actual size	EA, WA , WK, SA , SK	120, 350	0.125	3.18
Dual-pattern gage for use in back-to-back bending applications. Longitudinal grid centerlines spaced 0.250 in (6.35 mm) apart. Matrix size: 0.32L x 0.47W in. (8.1L x 11.9W mm)				
125UE  actual size	CEA	120, 350	0.125	3.18
General-purpose gage with large tab at each end of grid. Exposed solder tab area 0.08 x 0.07 in (2.0 x 1.8 mm). Matrix size: 0.57L x 0.20W in. (14.5L x 5.1W mm)				
230DS  actual size	EA, ED, WA , WK, EP, SA , SK , SD , WD	120, 350	0.23	5.84
General-purpose gage with very narrow geometry. Matrix size: 0.50L x 0.12W in. (12.7L x 3.0W mm)				
250AF  actual size	EA, ED, WA , WK, EP, SA , SK , SD , WD	120, 350	0.25	6.35
General-purpose gage with high-dissipation grid. Matrix size: 0.57L x 0.36W in. (14.5L x 9.1W mm)				
250BB  actual size	EA, ED, EP	120, 350	0.25	6.35
General-purpose gage with large solder tabs. Matrix size: 0.64L x 0.21W in. (16.3L x 6.9W mm)				
250BK  actual size	EA, WA , WK, SA , SK	1000, 3000	0.25	6.35
High-resistance gage with good power dissipation capability for high output applications or use on plastics. Matrix size: 0.58L x 0.27W in. (14.7L x 6.9W mm)				

Note 1: Products with designations and options shown in **bold** are not RoHS compliant.

See www.micro-measurements.com/stress-analysis-strain-gages/other-linear-patterns/ for complete specifications of patterns listed.

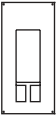
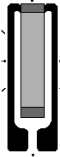
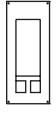
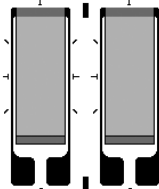
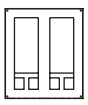
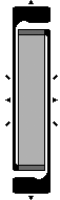
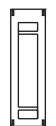
For all linear patterns offered, see www.micro-measurements.com/stress-analysis-strain-gages/all-linear-patterns/

General Purpose Strain Gages

GAGE PATTERN	GAGE SERIES See Note 1	GAGE RESISTANCE (OHMS)	GAGE LENGTH	
			inches	millimeters
250BM   <p>actual size</p>	EA, ED, WA , WK, EP, SA, SK, SD , WD	500, 1500	0.25	6.35
	General-purpose gage with high-resistance grid. Matrix size: 0.58L x 0.27W in. (14.7L x 6.9W mm)			
250BP   <p>actual size</p>	SK , WK, ED, SD , WD	120	0.25	6.35
	A general-purpose gage used primarily to obtain 120-ohm grid resistance in SK and WK Series. Matrix size: 0.53L x 0.22W in. (13.5L x 5.6W mm)			
250MQ   <p>actual size</p>	EA, ED, EK, WA , WK, SA, SK, SD , WD	350, 1000	0.25	6.35
	Dual pattern for back-to-back bending applications. Longitudinal grid centerlines are spaced 0.185 in (4.70 mm) apart. EK-Series gages are supplied with duplex copper pads (DP) when optional feature W or SE is not specified. Matrix size: 0.47L x 0.40W in. (11.9L x 10.2W mm)			
350DD   <p>actual size</p>	EA, ED, WA , WK, EP, SA, SK, SD , WD	350, 1000	0.35	8.89
	General-purpose gage with narrow pattern geometry and tab at each end of grid. Matrix size: 0.61L x 0.18W in. (15.5L x 4.6W mm)			
375BG   <p>actual size</p>	EA, ED, WA , WK, EP, SA, SK, SD , WD	120, 350	0.375	9.53
	General-purpose gage. Matrix size: 0.71L x 0.29W in. (18.0L x 7.4W mm)			
500BL   <p>actual size</p>	EA, ED, WA , WK, EP, SA, SK, SD , WD	350, 1000	0.5	12.7
	Widely used general-purpose gage with compact geometry. Matrix size: 0.87L x 0.27W in. (22.1L x 6.9W mm)			

Note 1: Products with designations and options shown in **bold** are not RoHS compliant.

See www.micro-measurements.com/stress-analysis-strain-gages/other-linear-patterns/ for complete specifications of patterns listed.

For all linear patterns offered, see www.micro-measurements.com/stress-analysis-strain-gages/all-linear-patterns/

General Purpose Strain Gages

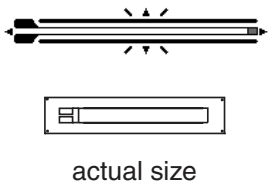
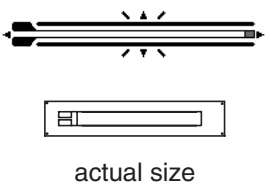
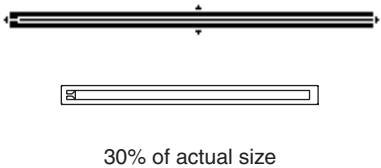
GAGE PATTERN	GAGE SERIES See Note 1	GAGE RESISTANCE (OHMS)	GAGE LENGTH	
			inches	millimeters
500GB  <p>actual size</p>	EA, ED, WA , WK, EP, SA, SK, SD , WD	120, 350	0.5	12.7
<p>General-purpose gage with very narrow geometry. See also 500GC pattern. Matrix size: 0.75L x 0.15W in. (19.1L x 3.8W mm)</p>				
500GC  <p>actual size</p>	EA, ED, WA , WK, EP, SA, SK, SD , WD	350, 1000	0.5	12.7
<p>General-purpose gage with very narrow geometry. Matrix size: 0.78L x 0.15W in. (19.8L x 3.8W mm)</p>				
40CBY  <p>30% of actual size</p>	N2A, EA, WA , WK, EP, SA, SK	120, 350	4	101.6
<p>For use on concrete and for strain integration on large specimens. Matrix size: 4.49L x 0.33W in. (114.0L x 8.4W mm)</p>				

Note 1: Products with designations and options shown in **bold** are not RoHS compliant.

See www.vishaypg.com/micro-measurements/stress-analysis-strain-gages/other-linear-patterns/ for complete specifications.

For all linear patterns offered, see www.micro-measurements.com/stress-analysis-strain-gages/all-linear-patterns/

Tee Rosettes (General-Use)

FEATURES

- Gage patterns designed for measuring orthogonal strains
- All patterns have two grids oriented at 0° and 90° angles
- Both stacked and planar constructions available
- Gage lengths from 0.050" (1.27 mm) to 0.250" (6.35 mm)

PATTERNS

050TG	66
062LT	67
062TJ	68
062TT	69
062TZ	70
062UT	71
062WT	72
120WT	73
125LT	74
125TG	75
125TM	76
125UT	77
125WT	78
250TM	79
250UT	80
Other Tee Rosettes	81

General Purpose Strain Gages – Tee Rosette

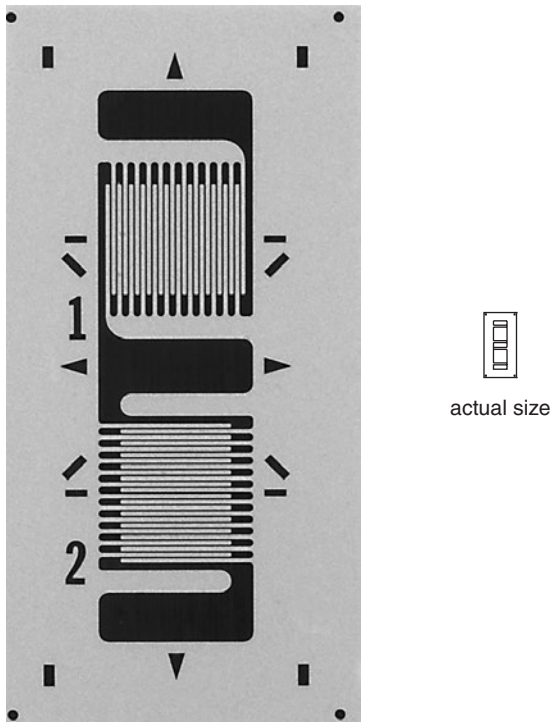
GAGE PATTERN DATA							
 <p>actual size</p>			GAGE DESIGNATION See Note 1, 3	RESISTANCE (OHMS) See Note 2	OPTIONS AVAILABLE See Note 3		
			EA-XX-050TG-350 WA-XX-050TG-350 EP-08-050TG-350 SA-XX-050TG-350	350 ± 0.2% 350 ± 0.4% 350 ± 0.2% 350 ± 0.4%	L, LE		
DESCRIPTION Miniature high-resistance 90° tee rosette. Sections have a common solder tab.							
GAGE DIMENSIONS		Legend ES = Each Section CP = Complete Pattern S = Section (S1 = Section 1) M = Matrix					
				<table border="1"> <tr><td>inch</td></tr> <tr><td>millimeter</td></tr> </table>	inch	millimeter	
inch							
millimeter							
Gage Length	Overall Length	Grid Width	Overall Width	Matrix Length	Matrix Width		
0.050 ES	0.250 CP	0.070 ES	0.070 CP	0.34	0.17		
1.27 ES	6.35 CP	1.78 ES	1.78 CP	8.6	4.3		



GAGE SERIES DATA — See Gage Series datasheet for complete specifications			
Series	Description	Strain Range	Temperature Range
EA	Constantan foil in combination with a tough, flexible, polyimide backing.	±3%	-100° to +350°F (-75° to +175°C)
WA	Fully encapsulated constantan gages with high-endurance leadwires.	±2%	-100° to +400°F (-75° to +205°)
EP	Annealed constantan foil with tough, high-elongation polyimide backing.	±10%	-100° to +400°F (-75° to +205°C)
SA	Fully encapsulated constantan gages with solder dots.	±2%	-100° to +400°F (-75° to +205°C)

Note 1: Insert desired S-T-C number in spaces marked XX.

Note 2: Tolerance is increased when Option W, E, SE, LE, or P is specified.

Note 3: Products with designations and options shown in **bold** are not RoHS compliant.

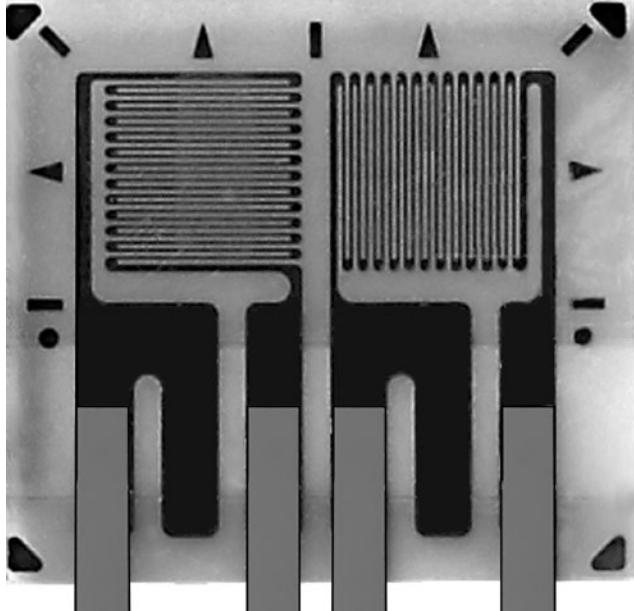
General Purpose Strain Gages – Tee Rosette

GAGE PATTERN DATA					
 <p style="text-align: center;">actual size</p>			GAGE DESIGNATION See Note 1	RESISTANCE (OHMS)	OPTIONS AVAILABLE
			L2A-XX-062LT-120 L2A-XX-062LT-350 C2A-XX-062LT-120 C2A-XX-062LT-350	120 ± 0.6% 350 ± 0.6% 120 ± 0.6% 350 ± 0.6%	
DESCRIPTION General-purpose 90° rosette.					 RoHS COMPLIANT
GAGE DIMENSIONS		Legend ES = Each Section S = Section (S1 = Section 1) CP = Complete Pattern M = Matrix			<input type="checkbox"/> inch <input type="checkbox"/> millimeter
Gage Length	Overall Length	Grid Width	Overall Width	Matrix Length	Matrix Width
0.062	0.164	0.070	0.170	0.210	0.230
1.52	4.17	1.78	4.32	5.33	5.84

GAGE SERIES DATA — See Gage Series datasheet for complete specifications			
Series	Description	Strain Range	Temperature Range
L2A	Encapsulated constantan gages with preattached ribbon leads.	±3%	-100° to +250°F (-75° to +120°C)
C2A	Encapsulated constantan gages with preattached ready-to-use cables.	±3%	-60° to +180°F (-50° to +80°C)



Example of an
L2A Construction



Example of an
C2A Construction

Note 1: Insert desired S-T-C number in spaces marked XX.

General Purpose Strain Gages – Tee Rosette

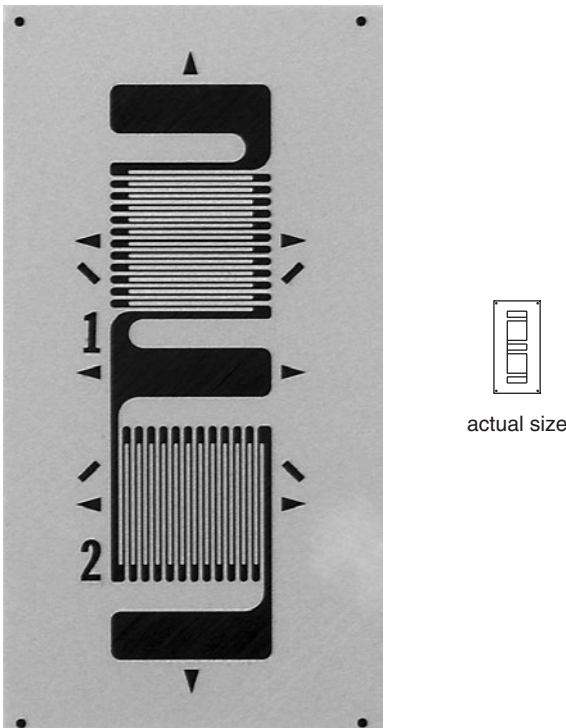
GAGE PATTERN DATA					
		GAGE DESIGNATION See Note 1, 2	RESISTANCE (OHMS)	OPTIONS AVAILABLE See Note 2	
		EA-XX-062TJ-120 EA-XX-062TJ-350 SA-XX-062TJ-120 SA-XX-062TJ-350	120 ± 0.2% 350 ± 0.2% 120 ± 0.4% 350 ± 0.4%	DESCRIPTION General-purpose 90° tee rosette. Sections have a common solder tab.	
GAGE DIMENSIONS		Legend			
		ES = Each Section S = Section (S1 = Section 1)		CP = Complete Pattern M = Matrix	
				inch	millimeter
Gage Length	Overall Length	Grid Width	Overall Width	Matrix Length	Matrix Width
0.062 ES	0.295 CP	0.080 ES	0.080 CP	0.38	0.19
1.57 ES	7.49 CP	2.03 ES	2.03 CP	12.2	4.8

GAGE SERIES DATA — See Gage Series datasheet for complete specifications			
Series	Description	Strain Range	Temperature Range
EA	Constantan foil in combination with a tough, flexible, polyimide backing.	±3%	-100° to +350°F (-75° to +175°C)
SA	Fully encapsulated constantan gages with solder dots.	±2%	-100° to +400°F (-75° to +205°C)

Note 1: Insert desired S-T-C number in spaces marked XX.

Note 2: Tolerance is increased when Option W, E, SE, LE, or P is specified.

General Purpose Strain Gages – Tee Rosette

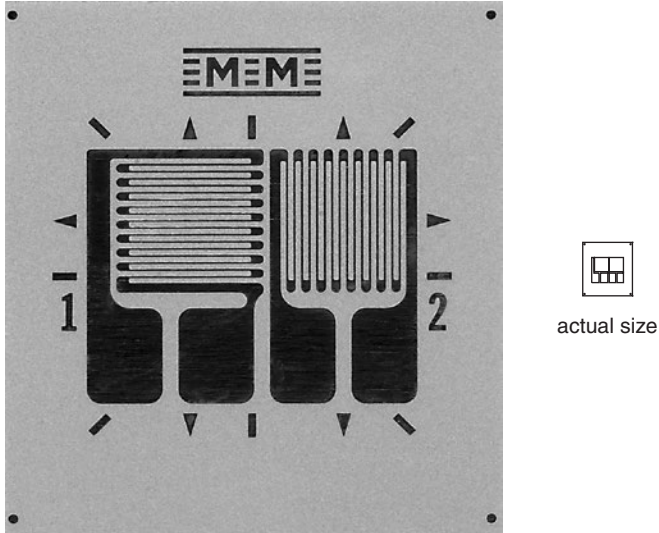
GAGE PATTERN DATA					
		GAGE DESIGNATION See Note 1, 3	RESISTANCE (OHMS) See Note 2	OPTIONS AVAILABLE See Note 3	
		EA-XX-062TT-120 EA-XX-062TT-350 EK-XX-062TT-350 WA-XX-062TT-120 WA-XX-062TT-350 WK-XX-062TT-350 EP-XX-062TT-120 EP-XX-062TT-350 SA-XX-062TT-120 SA-XX-062TT-350 SK-XX-062TT-350	120 ± 0.2% 350 ± 0.2% 350 ± 0.2% 120 ± 0.4% 350 ± 0.4% 350 ± 0.4% 120 ± 0.2% 350 ± 0.2% 120 ± 0.4% 350 ± 0.4% 350 ± 0.4%	W, E, L, LE W, E, L, LE W, SE W* W* W*	
DESCRIPTION General-purpose 90° tee rosette. Sections are electrically independent. EK-Series gages are supplied with duplex copper pads (DP) when optional feature W or SE is not specified.					
GAGE DIMENSIONS		Legend ES = Each Section S = Section (S1 = Section 1) CP = Complete Pattern M = Matrix			<input type="checkbox"/> inch <input type="checkbox"/> millimeter
Gage Length	Overall Length	Grid Width	Overall Width	Matrix Length	Matrix Width
0.062 ES	0.133 CP	0.075 ES	0.168 CP	0.28	0.26
1.57 ES	3.38 CP	1.91 ES	4.27 CP	7.1	6.6

GAGE SERIES DATA — See Gage Series datasheet for complete specifications			
Series	Description	Strain Range	Temperature Range
EA	Constantan foil in combination with a tough, flexible, polyimide backing.	±3%	-100° to +350°F (-75° to +175°C)
EK	K-alloy foil in combination with a tough, flexible polyimide backing.	±1.5%	-320° to +350°F (-195° to +175°C)
WA	Fully encapsulated constantan gages with high-endurance leadwires.	±2%	-100° to +400°F (-75° to +205°)
WK	Fully encapsulated K-alloy gages with high-endurance leadwires.	±1.5%	-452° to +550°F (-269° to +290°C)
EP	Annealed constantan foil with tough, high-elongation polyimide backing.	±10%	-100° to +400°F (-75° to +205°C)
SA	Fully encapsulated constantan gages with solder dots.	±2%	-100° to +400°F (-75° to +205°C)
SK	Fully encapsulated K-alloy gages with solder dots.	±1.5%	-452° to +450°F (-269° to +230°C)

Note 1: Insert desired S-T-C number in spaces marked XX.

Note 2: Tolerance is increased when Option W, E, SE, LE, or P is specified.

Note 3: Products with designations and options shown in **bold** are not RoHS compliant.

*Options available but not normally recommended. See Optional Features datasheet for details.

General Purpose Strain Gages – Tee Rosette

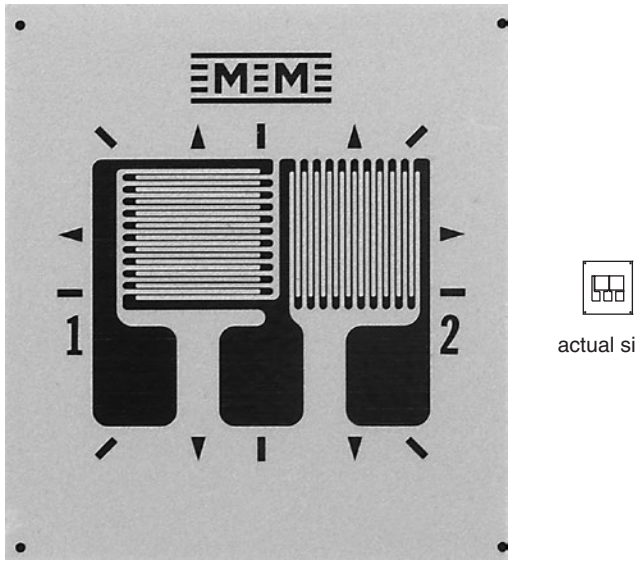
GAGE PATTERN DATA							
 <p>actual size</p>			GAGE DESIGNATION See Note 1, 3	RESISTANCE (OHMS) See Note 2	OPTIONS AVAILABLE See Note 3		
			EA-XX-062TZ-350 WA-XX-062TZ-350 WK-XX-062TZ-120 SA-XX-062TZ-350 SK-XX-062TZ-120	350 ± 0.2% 350 ± 0.4% 120 ± 0.4% 350 ± 0.4% 120 ± 0.4%	W, E, L, LE		
DESCRIPTION General-purpose 90° tee rosette. Similar in geometry to 062TT pattern except common tab version.							
GAGE DIMENSIONS			Legend ES = Each Section CP = Complete Pattern S = Section (S1 = Section 1) M = Matrix				
					<table border="1"> <tr><td>inch</td></tr> <tr><td>millimeter</td></tr> </table>	inch	millimeter
inch							
millimeter							
Gage Length	Overall Length	Grid Width	Overall Width	Matrix Length	Matrix Width		
0.062 ES	0.133 CP	0.075 ES	0.168 CP	0.28	0.26		
1.57 ES	3.38 CP	1.91 ES	4.27 CP	7.1	6.6		

GAGE SERIES DATA — See Gage Series datasheet for complete specifications			
Series	Description	Strain Range	Temperature Range
EA	Constantan foil in combination with a tough, flexible, polyimide backing.	±3%	-100° to +350°F (-75° to +175°C)
WA	Fully encapsulated constantan gages with high-endurance leadwires.	±2%	-100° to +400°F (-75° to +205°)
WK	Fully encapsulated K-alloy gages with high-endurance leadwires.	±1.5%	-452° to +550°F (-269° to +290°C)
SA	Fully encapsulated constantan gages with solder dots.	±2%	-100° to +400°F (-75° to +205°C)
SK	Fully encapsulated K-alloy gages with solder dots.	±1.5%	-452° to +450°F (-269° to +230°C)

Note 1: Insert desired S-T-C number in spaces marked XX.

Note 2: Tolerance is increased when Option W, E, SE, LE, or P is specified.

Note 3: Products with designations and options shown in **bold** are not RoHS compliant.

General Purpose Strain Gages – Tee Rosette

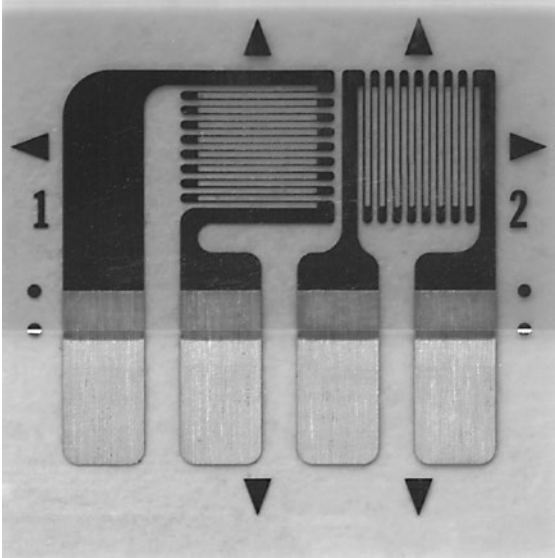

GAGE PATTERN DATA					
 <p style="text-align: center;">actual size</p>			GAGE DESIGNATION See Note 1	RESISTANCE (OHMS)	OPTIONS AVAILABLE See Note 2
			CEA-XX-062UT-120 CEA-XX-062UT-350	120 ± 0.4% 350 ± 0.4%	P2 P2
DESCRIPTION Small general-purpose two-element 90° tee rosette. Exposed solder tab area 0.07 x 0.04 in (1.8 x 1.0 mm).					
GAGE DIMENSIONS		Legend ES = Each Section CP = Complete Pattern S = Section (S1 = Section 1) M = Matrix			<input type="checkbox"/> inch <input type="checkbox"/> millimeter
Gage Length	Overall Length	Grid Width	Overall Width	Matrix Length	Matrix Width
0.062 ES	0.205 CP	0.080 ES	0.225 CP	0.31	0.31
1.57 ES	5.21 CP	2.03 ES	5.72 CP	7.9	7.9

GAGE SERIES DATA — See Gage Series datasheet for complete specifications			
Series	Description	Strain Range	Temperature Range
CEA	Universal general-purpose strain gages.	±3%	-100° to +350°F (-75° to +175°C)

Note 1: Insert desired S-T-C number in spaces marked XX.

Note 2: Products with designations and options shown in bold are not RoHS compliant.

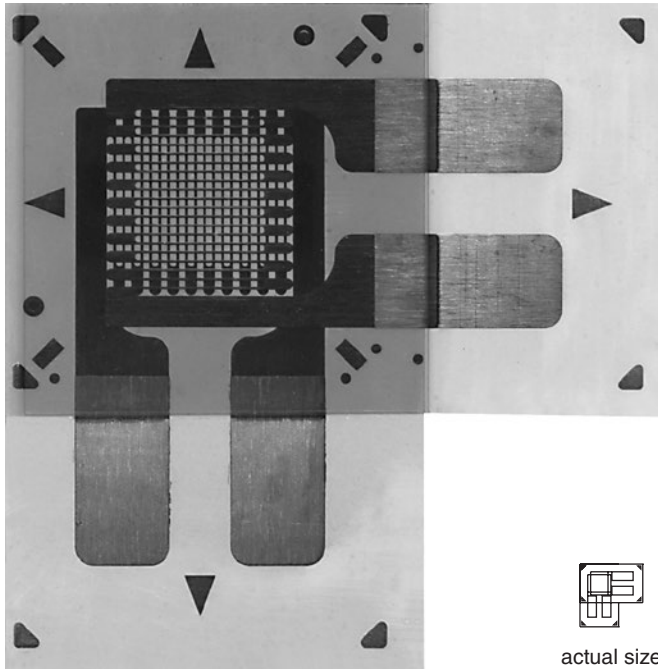
General Purpose Strain Gages – Tee Rosette

GAGE PATTERN DATA					
 <p style="text-align: center;">actual size</p>	GAGE DESIGNATION See Note 1		RESISTANCE (OHMS)		OPTIONS AVAILABLE
	CEA-XX-062WT-120 CEA-XX-062WT-350		120 ± 0.5% 350 ± 0.5%		
	DESCRIPTION Small two-element 90° stacked rosette. Exposed solder tab area 0.07 x 0.04 in (1.8 x 1.0 mm). Maximum operating temperature +150°F (+65°C).				 RoHS COMPLIANT
GAGE DIMENSIONS		Legend ES = Each Section CP = Complete Pattern S = Section (S1 = Section 1) M = Matrix			
				<input type="checkbox"/> inch <input type="checkbox"/> millimeter	
Gage Length	Overall Length	Grid Width	Overall Width	Matrix Length	Matrix Width
0.062 ES	0.235 CP	0.120 ES	0.235 CP	0.33	0.33
1.57 ES	5.97 CP	3.05 ES	5.97 CP	8.3	8.3

GAGE SERIES DATA — See Gage Series datasheet for complete specifications			
Series	Description	Strain Range	Temperature Range
CEA	Universal general-purpose strain gages.	±3%	-100° to +150°F (-75° to +65°C)

Note 1: Insert desired S-T-C number in spaces marked XX.

General Purpose Strain Gages – Tee Rosette

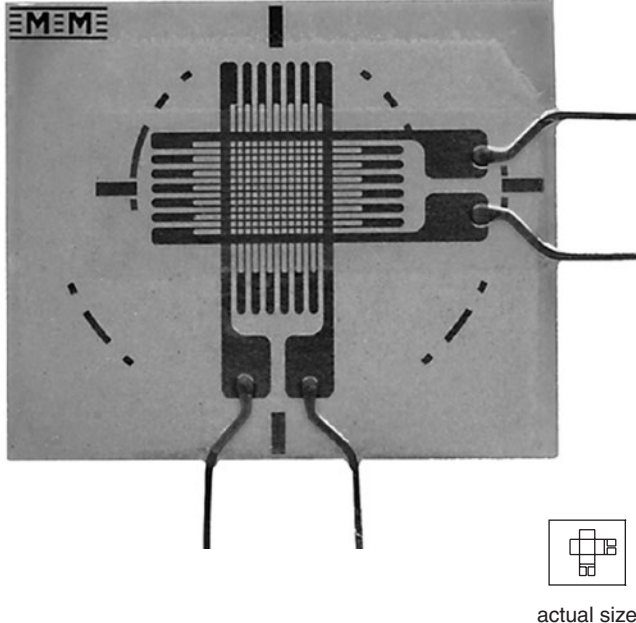

GAGE PATTERN DATA					
			GAGE DESIGNATION See Note 1, 2	RESISTANCE (OHMS)	OPTIONS AVAILABLE See Note 2
			WA-XX-120WT-120 WA-XX-120WT-350 WD-DY-120WT-350 WK-XX-120WT-120 WK-XX-120WT-350 SA-XX-120WT-120 SA-XX-120WT-350 SK-XX-120WT-120 SK-XX-120WT-350 SD-DY-120WT-350	120 ± 0.5% 350 ± 0.5% 350 ± 0.5% 120 ± 0.5% 350 ± 0.5% 120 ± 0.5% 350 ± 0.5% 120 ± 0.5% 350 ± 0.5% 350 ± 0.5%	
			DESCRIPTION Two-element 90° tee stacked rosette. See also 125WT pattern.		
GAGE DIMENSIONS		Legend ES = Each Section S = Section (S1 = Section 1) CP = Complete Pattern M = Matrix			<input type="checkbox"/> inch <input type="checkbox"/> millimeter
Gage Length	Overall Length	Grid Width	Overall Width	Matrix Length	Matrix Width
0.120 ES	0.34 M	0.080 ES	0.040 M	0.34	0.40
3.05 ES	8.6 M	2.03 ES	10.2 M	8.6	10.2

GAGE SERIES DATA — See Gage Series datasheet for complete specifications			
Series	Description	Strain Range	Temperature Range
WA	Fully encapsulated constantan gages with high-endurance leadwires.	±2%	-100° to +400°F (-75° to +205°)
WD	Fully encapsulated isoelastic gages with high-endurance leadwires.	±1.5%	-320° to +500°F (-195° to +260°C)
WK	Fully encapsulated K-alloy gages with high-endurance leadwires.	±1.5%	-452° to +550°F (-269° to +290°C)
SA	Fully encapsulated constantan gages with solder dots.	±2%	-100° to +400°F (-75° to +205°C)
SK	Fully encapsulated K-alloy gages with solder dots.	±1.5%	-452° to +450°F (-269° to +230°C)
SD	Equivalent to WD Series, but with solder dots instead of leadwires.	±1.5%	-320° to +400°F (-195° to +205°C)

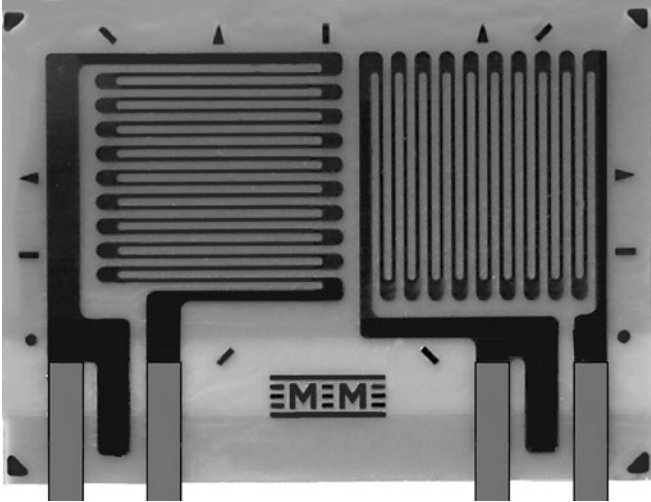

Note 1: Insert desired S-T-C number in spaces marked XX.

Note 2: Products with designations and options shown in bold are not RoHS compliant.

General Purpose Strain Gages – Tee Rosette

GAGE PATTERN DATA					
			GAGE DESIGNATION See Note 1	RESISTANCE (OHMS)	OPTIONS AVAILABLE
			L2A-XX-125LT-120 L2A-XX-125LT-350 C2A-XX-125LT-120 C2A-XX-125LT-350	120 ± 0.6% 350 ± 0.6% 120 ± 0.6% 350 ± 0.6%	
 actual size			DESCRIPTION General-purpose 90° rosette.		 RoHS COMPLIANT
GAGE DIMENSIONS		Legend ES = Each Section CP = Complete Pattern S = Section (S1 = Section 1) M = Matrix			inch millimeter
Gage Length	Overall Length	Grid Width	Overall Width	Matrix Length	Matrix Width
0.125 ES	0.243 CP	0.150 ES	0.340 CP	0.290	0.400
3.18 ES	6.17 CP	3.81 ES	8.64 CP	7.37	10.16

GAGE SERIES DATA — See Gage Series datasheet for complete specifications			
Series	Description	Strain Range	Temperature Range
L2A	Encapsulated constantan gages with preattached ribbon leads.	±3%	-100° to +250°F (-75° to +120°C)
C2A	Encapsulated constantan gages with preattached ready-to-use cables.	±3%	-60° to +180°F (-50° to +80°C)

 Example of an L2A Construction	 Example of an C2A Construction
--	---

Note 1: Insert desired S-T-C number in spaces marked XX.

General Purpose Strain Gages – Tee Rosette

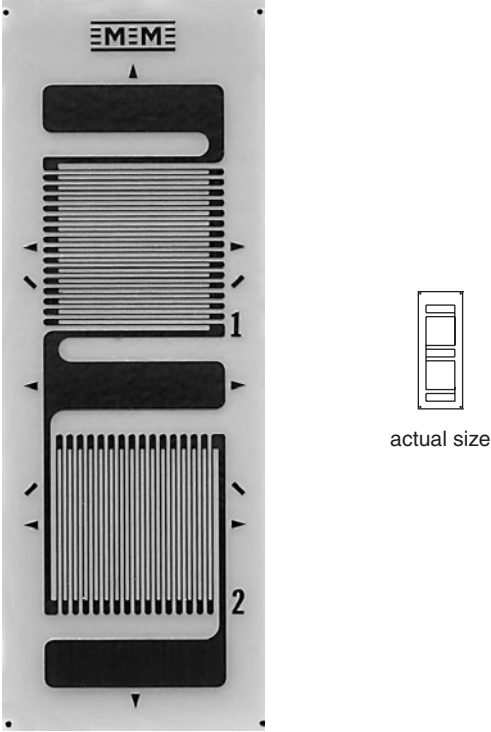
GAGE PATTERN DATA					
		GAGE DESIGNATION See Note 1, 3	RESISTANCE (OHMS) See Note 2	OPTIONS AVAILABLE See Note 3	
		EA-XX-125TG-350 EK-XX-125TG-10C WA-XX-125TG-350 SA-XX-125TG-350 SK-XX-125TG-10C	350 ± 0.2% 1000 ± 0.2% 350 ± 0.4% 350 ± 0.4% 1000 ± 0.4%	L, LE SE	
DESCRIPTION General-purpose two-element 90° tee rosette with high-resistance grid. Sections have a common electrical connection. EK-Series gages are supplied with duplex copper dots (DD) when optional feature SE is not specified.					
GAGE DIMENSIONS		Legend			<input type="checkbox"/> inch <input type="checkbox"/> millimeter
		ES = Each Section	CP = Complete Pattern		
		S = Section (S1 = Section 1)	M = Matrix		
Gage Length	Overall Length	Grid Width	Overall Width	Matrix Length	Matrix Width
0.125 ES	0.500 CP	0.150 ES	0.150 CP	0.61	0.23
3.18 ES	12.70 CP	3.81 ES	3.81 CP	15.5	5.8

GAGE SERIES DATA — See Gage Series datasheet for complete specifications			
Series	Description	Strain Range	Temperature Range
EA	Constantan foil in combination with a tough, flexible, polyimide backing.	±5%	-100° to +350°F (-75° to +175°C)
EK	K-alloy foil in combination with a tough, flexible polyimide backing.	±1.5%	-320° to +350°F (-195° to +175°C)
WA	Fully encapsulated constantan gages with high-endurance leadwires.	±2%	-100° to +400°F (-75° to +205°)
SA	Fully encapsulated constantan gages with solder dots.	±2%	-100° to +400°F (-75° to +205°C)
SK	Fully encapsulated K-alloy gages with solder dots.	±1.5%	-452° to +450°F (-269° to +230°C)

Note 1: Insert desired S-T-C number in spaces marked XX.

Note 2: Tolerance is increased when Option W, E, SE, LE, or P is specified.

Note 3: Products with designations and options shown in **bold** are not RoHS compliant.

General Purpose Strain Gages – Tee Rosette

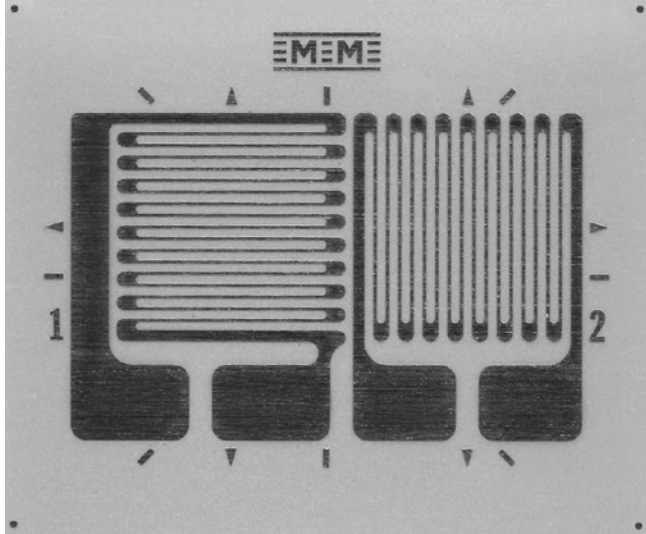
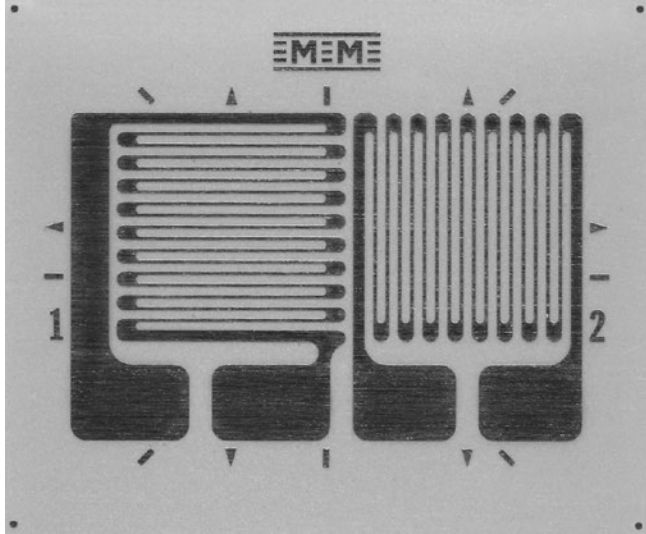
GAGE PATTERN DATA							
			GAGE DESIGNATION See Note 1, 3	RESISTANCE (OHMS) See Note 2	OPTIONS AVAILABLE See Note 3		
			EA-XX-125TM-120 WA-XX-125TM-120 WK-XX-125TM-350 EP-08-125TM-120 SA-XX-125TM-120 SK-XX-125TM-350	120 ± 0.2% 120 ± 0.4% 350 ± 0.4% 120 ± 0.2% 120 ± 0.4% 350 ± 0.4%	W, E, L, LE W* W*		
 actual size			DESCRIPTION General-purpose two-element 90° tee rosette. Sections are electrically independent. See also 125TQ and 125UT patterns.				
GAGE DIMENSIONS		Legend ES = Each Section CP = Complete Pattern S = Section (S1 = Section 1) M = Matrix					
					<table border="1"> <tr><td>inch</td></tr> <tr><td>millimeter</td></tr> </table>	inch	millimeter
inch							
millimeter							
Gage Length	Overall Length	Grid Width	Overall Width	Matrix Length	Matrix Width		
0.125 ES	0.215 CP	0.150 ES	0.335 CP	0.36	0.43		
3.18 ES	5.46 CP	3.81 ES	8.51 CP	9.1	10.9		

GAGE SERIES DATA — See Gage Series datasheet for complete specifications			
Series	Description	Strain Range	Temperature Range
EA	Constantan foil in combination with a tough, flexible, polyimide backing.	±5%	-100° to +350°F (-75° to +175°C)
WA	Fully encapsulated constantan gages with high-endurance leadwires.	±2%	-100° to +400°F (-75° to +205°)
WK	Fully encapsulated K-alloy gages with high-endurance leadwires.	±1.5%	-452° to +550°F (-269° to +290°C)
EP	Annealed constantan foil with tough, high-elongation polyimide backing.	±20%	-100° to +400°F (-75° to +205°C)
SA	Fully encapsulated constantan gages with solder dots.	±2%	-100° to +400°F (-75° to +205°C)
SK	Fully encapsulated K-alloy gages with solder dots.	±1.5%	-452° to +450°F (-269° to +230°C)

Note 1: Insert desired S-T-C number in spaces marked XX.

Note 2: Tolerance is increased when Option W, E, SE, LE, or P is specified.

Note 3: Products with designations and options shown in **bold** are not RoHS compliant.

*Options available but not normally recommended. See Optional Features datasheet for details.

General Purpose Strain Gages – Tee Rosette

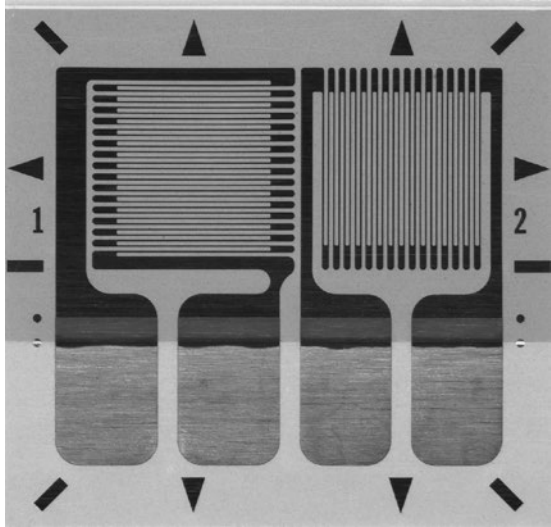

GAGE PATTERN DATA					
 <p style="text-align: center;">actual size</p>			GAGE DESIGNATION See Note 1	RESISTANCE (OHMS)	OPTIONS AVAILABLE See Note 1
			CEA-XX-125UT-120 CEA-XX-125UT-350	120 ± 0.4% 350 ± 0.4%	P2 P2
DESCRIPTION Two-element 90° tee rosette for general-purpose use. Exposed solder tab area 0.10 x 0.07 in (2.5 x 1.8 mm).					
GAGE DIMENSIONS		Legend			<input type="checkbox"/> inch <input type="checkbox"/> millimeter
		ES = Each Section S = Section (S1 = Section 1)			CP = Complete Pattern M = Matrix
Gage Length	Overall Length	Grid Width	Overall Width	Matrix Length	Matrix Width
0.125 ES	0.325 CP	0.165 ES	0.365 CP	0.42	0.45
3.18 ES	8.26 CP	4.19 ES	9.27 CP	10.7	11.4

GAGE SERIES DATA — See Gage Series datasheet for complete specifications			
Series	Description	Strain Range	Temperature Range
CEA	Universal general-purpose strain gages.	±5%	-100° to +350°F (-75° to +175°C)

Note 1: Insert desired S-T-C number in spaces marked XX.

Note 2: Products with designations and options shown in bold are not RoHS compliant.

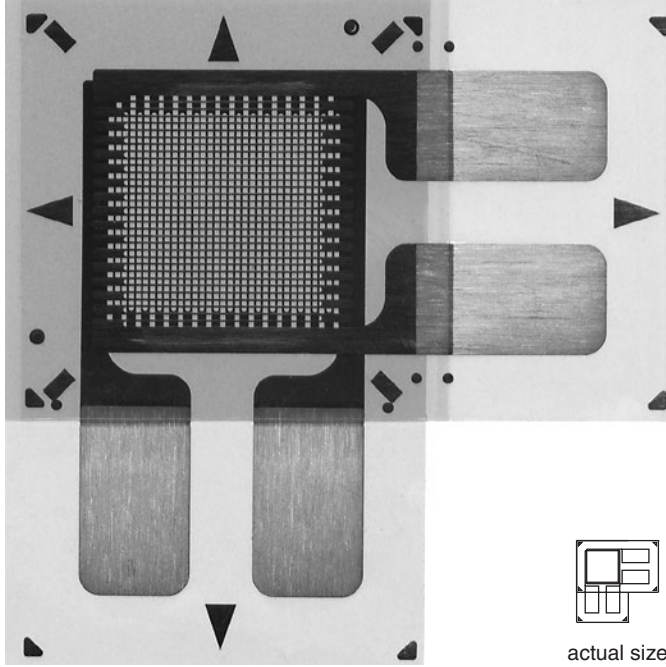
General Purpose Strain Gages – Tee Rosette

GAGE PATTERN DATA					
  actual size			GAGE DESIGNATION See Note 1	RESISTANCE (OHMS)	OPTIONS AVAILABLE
			CEA-XX-125WT-120 CEA-XX-125WT-350	120 ± 0.5% 350 ± 0.5%	
DESCRIPTION Two-element 90° tee stacked rosette. Exposed solder tab area 0.10 x 0.07 in [2.5 x 1.8 mm]. Maximum operating temperature +150°F [+65°C].					 RoHS COMPLIANT
GAGE DIMENSIONS		Legend			inch
		ES = Each Section CP = Complete Pattern S = Section (S1 = Section 1) M = Matrix			millimeter
Gage Length	Overall Length	Grid Width	Overall Width	Matrix Length	Matrix Width
0.125 ES	0.325 CP	0.180 ES	0.325 CP	0.42	0.42
3.18 ES	8.2 CP	4.57 ES	8.26 CP	10.7	10.7

GAGE SERIES DATA — See Gage Series datasheet for complete specifications			
Series	Description	Strain Range	Temperature Range
CEA	Universal general-purpose strain gages.	±3%	-100° to +150°F (-75° to +65°C)

Note 1: Insert desired S-T-C number in spaces marked XX.

General Purpose Strain Gages – Tee Rosette

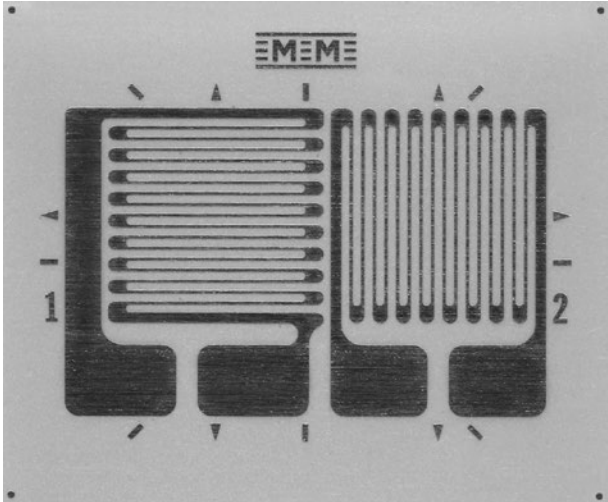
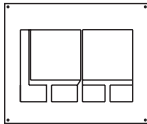
GAGE PATTERN DATA							
		GAGE DESIGNATION See Note 1, 3	RESISTANCE (OHMS) See Note 2	OPTIONS AVAILABLE See Note 3			
		EA-XX-125TM-120 WA-XX-125TM-120 WK-XX-125TM-350 EP-08-125TM-120 SA-XX-125TM-120 SK-XX-125TM-350	120 ± 0.2% 120 ± 0.4% 350 ± 0.4% 120 ± 0.2% 120 ± 0.4% 350 ± 0.4%	W, E, L, LE W* W*			
 <p>actual size</p>		DESCRIPTION General-purpose two-element 90° tee rosette. Sections are electrically independent. See also 250UT pattern.					
GAGE DIMENSIONS		Legend ES = Each Section S = Section (S1 = Section 1)			<table border="1"> <tr><td>inch</td></tr> <tr><td>millimeter</td></tr> </table>	inch	millimeter
inch							
millimeter							
Gage Length	Overall Length	Grid Width	Overall Width	Matrix Length	Matrix Width		
0.250 ES	0.430 CP	0.300 ES	0.670 CP	0.53	0.75		
6.35 ES	10.92 CP	7.62 ES	17.02 CP	13.5	19.1		

GAGE SERIES DATA — See Gage Series datasheet for complete specifications			
Series	Description	Strain Range	Temperature Range
EA	Constantan foil in combination with a tough, flexible, polyimide backing.	±5%	-100° to +350°F (-75° to +175°C)
WA	Fully encapsulated constantan gages with high-endurance leadwires.	±2%	-100° to +400°F (-75° to +205°)
WK	Fully encapsulated K-alloy gages with high-endurance leadwires.	±1.5%	-452° to +550°F (-269° to +290°C)
EP	Annealed constantan foil with tough, high-elongation polyimide backing.	±20%	-100° to +400°F (-75° to +205°C)
SA	Fully encapsulated constantan gages with solder dots.	±2%	-100° to +400°F (-75° to +205°C)
SK	Fully encapsulated K-alloy gages with solder dots.	±1.5%	-452° to +450°F (-269° to +230°C)

Note 1: Insert desired S-T-C number in spaces marked XX.

Note 2: Tolerance is increased when Option W, E, SE, LE, or P is specified.

Note 3: Products with designations and options shown in **bold** are not RoHS compliant.

*Options available but not normally recommended. See Optional Features datasheet for details.

General Purpose Strain Gages – Tee Rosette

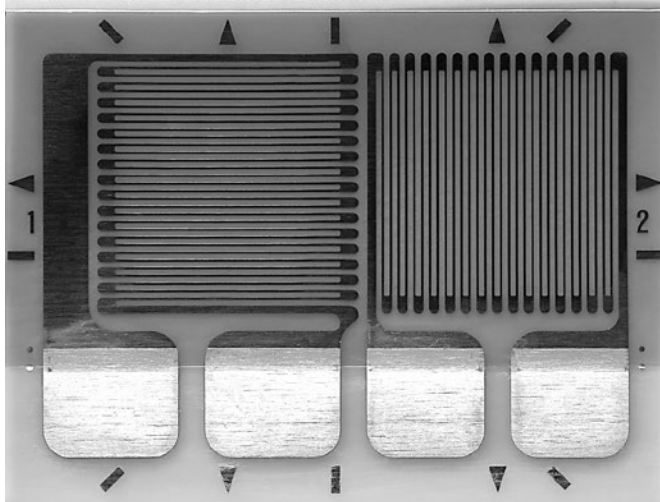
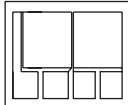









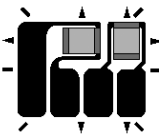

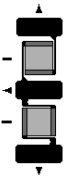
GAGE PATTERN DATA					
			GAGE DESIGNATION See Note 1, 3	RESISTANCE (OHMS) See Note 2	OPTIONS AVAILABLE See Note 3
			CEA-XX-250UT-120 CEA-XX-250UT-350 CEA-XX-250UT-10C	120 ± 0.4% 350 ± 0.4% 1000 ± 0.4%	P2 P2 P2
 actual size			DESCRIPTION Two-element 90° tee rosette for general-purpose use. Exposed solder tab area 0.13 x 0.10 in (3.3 x 2.5 mm).		
GAGE DIMENSIONS		Legend ES = Each Section CP = Complete Pattern S = Section (S1 = Section 1) M = Matrix			
				inch	
				millimeter	
Gage Length	Overall Length	Grid Width	Overall Width	Matrix Length	Matrix Width
0.250 ES	0.450 CP	0.290 ES	0.650 CP	0.55	0.74
6.35 ES	11.43 CP	7.37 ES	16.51 CP	14.0	18.8

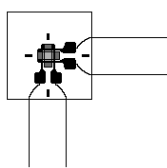
GAGE SERIES DATA — See Gage Series datasheet for complete specifications			
Series	Description	Strain Range	Temperature Range
CEA	Universal general-purpose strain gages.	±5%	-100° to +350°F (-75° to +175°C)

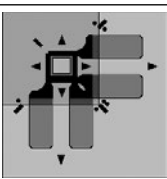
Note 1: Insert desired S-T-C number in spaces marked XX.

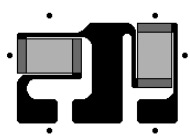
Note 2: Products with designations and options shown in bold are not RoHS compliant.

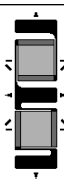









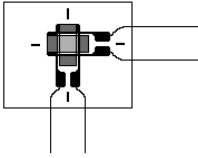

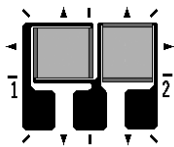
General Purpose Strain Gages

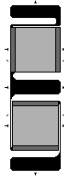
GAGE PATTERN	GAGE SERIES See Note 1	GAGE RESISTANCE (OHMS)	GAGE LENGTH	
			inches	millimeters
030TU   <p>actual size</p>	EA, EP, SA, SK	120, 350	0.03	0.76
	Miniature 90° tee rosette. Sections are electrically independent. Matrix size: 0.25L x 0.25W in. (6.4L x 6.4W mm)			
030TY   <p>actual size</p>	EA, EP, SA, SK	120, 350	0.03	0.76
	Miniature 90° tee rosette with large solder tabs. Matrix size: 0.30L x 0.15W in. (7.6L x 3.8W mm)			
030WT   <p>actual size</p>	WA, WK, SA, SK	120	0.03	0.76
	Miniature two-element 90° tee stacked rosette. See also 032WT pattern. Matrix size: 0.17L x 0.19W in. (4.3L x 4.8W mm)			
032WT   <p>actual size</p>	CEA	120	0.032	0.81
	Miniature two-element 90° stacked rosette. Exposed solder tab area is 0.07 x 0.04 in (1.8 x 1.0 mm). Maximum operating temperature +150°F (+65°C). Matrix size: 0.30L x 0.30W in. (7.6L x 7.6W mm)			
044TP   <p>actual size</p>	EA, SA	350	0.044	1.12
	Miniature high-resistance 90° tee rosette. Matrix size: 0.14L x 0.20W in. (3.6L x 5.1W mm)			
050TG   <p>actual size</p>	EA, WA, EP, SA	350	0.05	1.27
	Miniature high-resistance 90° tee rosette. Sections have a common solder tab. Matrix size: 0.34L x 0.17W in. (8.6L x 4.3W mm)			

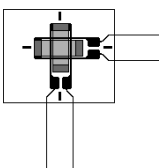
Note 1: Products with designations and options shown in **bold** are not RoHS compliant.

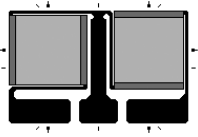
See <http://www.micro-measurements.com/stress-analysis-strain-gages/other-tee-rosettes/> for complete specifications.

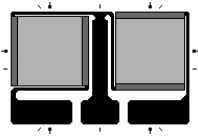
General Purpose Strain Gages

GAGE PATTERN	GAGE SERIES See Note 1	GAGE RESISTANCE (OHMS)	GAGE LENGTH	
			inches	millimeters
060WT   <p>actual size</p>	WA, WK, SA, SK	120, 350, 1000	0.06	1.52
Small two-element 90° tee stacked rosette. Matrix size: 0.24L x 0.30W in. (6.1L x 7.6W mm)				
062TZ   <p>actual size</p>	EA, WA, WK, SA, SK	120, 350	0.062	1.57
General-purpose 90° tee rosette. Matrix size: 0.28L x 0.26W in. (7.1L x 6.6W mm)				
100TG   <p>actual size</p>	EA, WA, SA	350, 1000	0.1	2.54
Small high-resistance 90° tee rosette for general-purpose use. Matrix size: 0.50L x 0.19W in. (12.7L x 4.8W mm)				
120WT   <p>actual size</p>	WA, WD, WK, SA, SK, SD	120, 350	0.12	3.05
Two-element 90° tee stacked rosette. Matrix size: 0.34L x 0.40W in. (8.6L x 10.2W mm)				
125TA   <p>actual size</p>	EA, WA, WK, SA, SK	120, 350	0.125	3.18
General-purpose two-element 90° tee rosette. Sections have a common electrical connection. See also 125TB pattern. Matrix size: 0.36L x 0.41W in. (9.1L x 10.4W mm)				
125TB   <p>actual size</p>	EA, EK, WA, WK, SA, SK	350, 1000	0.125	3.18
General-purpose two-element 90° tee rosette. Same geometry as 125TA but with higher resistance. Sections have common electrical connection. EK-Series gages are supplied with duplex copper dots (DD) when optional feature W or SE is not specified. Matrix size: 0.36L x 0.44W in. (9.1L x 11.2W mm)				

Note 1: Products with designations and options shown in **bold** are not RoHS compliant.

See <http://www.micro-measurements.com/stress-analysis-strain-gages/other-tee-rosettes/> for complete specifications.

General Purpose Strain Gages

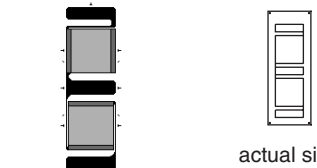
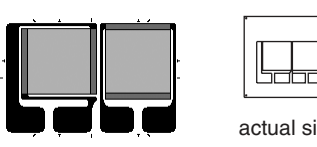
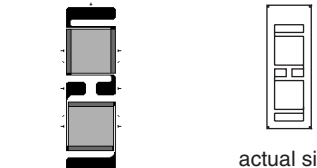
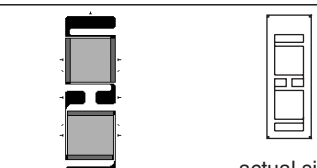
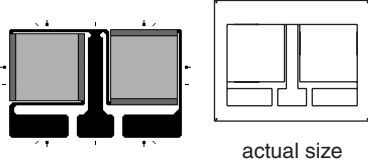
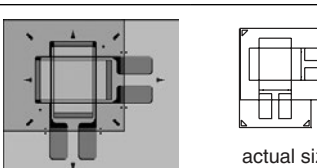
GAGE PATTERN	GAGE SERIES See Note 1	GAGE RESISTANCE (OHMS)	GAGE LENGTH	
			inches	millimeters
125TF  <p>actual size</p>	EA, SA , SK	120, 350	0.125	3.18
General-purpose two-element 90° tee rosette with narrow pattern geometry. Sections have a common electrical connection. Matrix size: 0.59L x 0.21W in. (15.0L x 5.3W mm)				
125TQ  <p>actual size</p>	EA, ED, WA , WK, EP, SA , SK	350, 1000	0.125	3.18
General-purpose two-element 90° tee rosette. EK-Series gages are supplied with duplex copper dots (DD) when optional feature W or SE is not specified. Matrix size: 0.42L x 0.47W in. (10.7L x 11.9W mm)				
125VA  <p>actual size</p>	EA, EP, SA , SK	350, 1000	0.125	3.18
General-purpose two-element 90° tee rosette with high-resistance grid. See also 125VB pattern. Matrix size: 0.64L x 0.23W in. (16.3L x 5.8W mm)				
125VB  <p>actual size</p>	EA, EP, SA , SK	120, 350	0.125	3.18
General-purpose two-element 90° tee rosette. Similar to 125TF pattern except sections are electrically independent. See also 125VA pattern. Matrix size: 0.64L x 0.23W in. (16.3L x 5.8W mm)				
250TB  <p>actual size</p>	EA, EK, WA , WK, SA , SK	350, 1000	0.25	6.35
General-purpose two-element 90° tee rosette. EK-Series gages are supplied with duplex copper pads (DP) when optional feature W or SE is not specified. Matrix size: 0.63L x 0.81W in. (16.0L x 20.6W mm)				
250WQ  <p>actual size</p>	CEA	350	0.25	6.35
Two-element 90° tee stacked rosette. Maximum operating temperature +150°F (+65°C). Exposed solder tab area is 0.11 x 0.07 in (2.8 x 1.8 mm). Matrix size: 0.55L x 0.55W in. (14.0L x 14.0W mm)				

Note 1: Products with designations and options shown in **bold** are not RoHS compliant.

See <http://www.micro-measurements.com/stress-analysis-strain-gages/other-tee-rosettes/> for complete specifications.

General Purpose Strain Gages

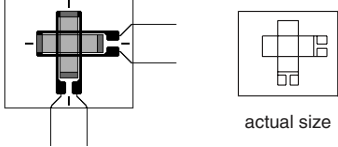
GAGE PATTERN	GAGE SERIES See Note 1	GAGE RESISTANCE (OHMS)	GAGE LENGTH	
			inches	millimeters
250WT 	WA, WD, WK, SA, SK, SD	120, 350	0.25	6.35
Two-element 90° tee stacked rosette. Matrix size: 0.51L x 0.60W in. (13.0L x 15.2W mm)				

Note 1: Products with designations and options shown in **bold** are not RoHS compliant.

See <http://www.micro-measurements.com/stress-analysis-strain-gages/other-tee-rosettes/> for complete specifications.

Rectangular Rosettes (General-Use)

FEATURES

- Gage patterns designed for determining principle stresses and strains
- All patterns have three grids oriented at 0°, 45° and 90° angles
- Both stacked and planar constructions available
- Gage lengths from 0.031" (0.79 mm) to 0.250" (6.35 mm)

PATTERNS

031RB	86
031WW	87
G1350	88
060WR	89
062LR	90
062UR	91
062WW	92
120WR	93
125LR	94
125RA	95
125UR	96
125WW	97
250LR	98
250UR	99
250WW	100
Other Rectangular Rosettes	101

General Purpose Strain Gages—Rectangular Pattern

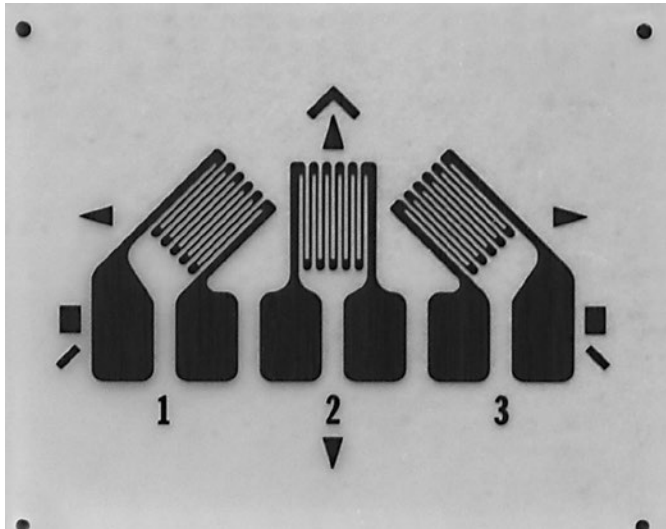
GAGE PATTERN DATA					
 <p style="text-align: center;">actual size</p>			GAGE DESIGNATION See Note 1, 3	RESISTANCE (OHMS) See Note 2	OPTIONS AVAILABLE See Note 3
			EA-XX-031RB-120 EP-08-031RB-120 SA-XX-031RB-120	120 ± 0.4% 120 ± 0.4% 120 ± 0.8%	E, SE, L, LE
DESCRIPTION Miniature 45° rectangular single-plane rosette with compact geometry.					
GAGE DIMENSIONS		Legend ES = Each Section CP = Complete Pattern S = Section (S1 = Section 1) M = Matrix			
				inch	millimeter
Gage Length	Overall Length	Grid Width	Overall Width	Matrix Length	Matrix Width
0.031ES	0.085 CP	0.031 ES	0.175 CP	0.19	0.30
0.79 ES	2.16 CP	0.79 ES	4.45 CP	4.8	6.1



GAGE SERIES DATA — See Gage Series datasheet for complete specifications			
Series	Description	Strain Range	Temperature Range
EA	Constantan foil in combination with a tough, flexible, polyimide backing.	±3%	-100° to +350°F (-75° to +175°C)
EP	Annealed constantan foil with tough, high-elongation polyimide backing.	±10%	-100° to +400°F (-75° to +205°C)
SA	Fully encapsulated constantan gages with solder dots.	±2%	-100° to +400°F (-75° to +205°C)

Note 1: Insert desired S-T-C number in spaces marked XX.

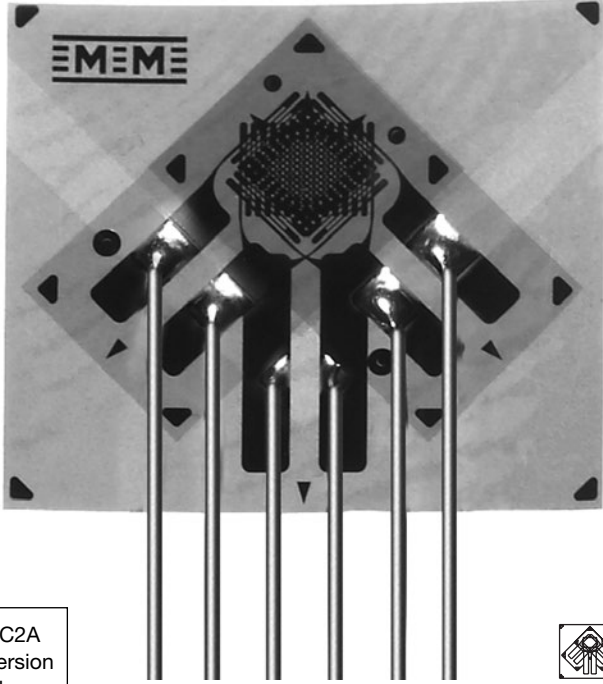

Note 2: Tolerance is increased when Option W, E, SE, LE, or P is specified.

Note 3: Products with designations and options shown in **bold** are not RoHS compliant.

General Purpose Strain Gages—Stacked Rosette

GAGE PATTERN DATA					
			GAGE DESIGNATION See Note 1	RESISTANCE (OHMS)	OPTIONS AVAILABLE
			L2A-XX-031WW-120 L2A-XX-031WW-350 C2A-XX-031WW-120 C2A-XX-031WW-350	120 ± 0.6% 350 ± 0.6% 120 ± 0.6% 350 ± 0.6%	
DESCRIPTION Stacked, 0°-45°-90° rosette for use in applications involving limited gaging areas or steep strain gradients.					 RoHS COMPLIANT
GAGE DIMENSIONS		Legend ES = Each Section CP = Complete Pattern S = Section (S1 = Section 1) M = Matrix			<input type="checkbox"/> inch <input type="checkbox"/> millimeter
Gage Length	Overall Length	Grid Width	Overall Width	Matrix Length	Matrix Width
0.031 ES	0.206 CP	0.070 ES	0.227 CP	0.278	0.315
0.79 ES	5.23 CP	1.79 ES	5.77 CP	7.06	8.00



GAGE SERIES DATA — See Gage Series datasheet for complete specifications			
Series	Description	Strain Range	Temperature Range (See Note 2)
L2A	Encapsulated constantan gages with preattached ribbon leads.	±3%	-100° to +150°F (-75° to +65°C)
C2A	Encapsulated constantan gages with preattached ready-to-use cables.	±3%	-60° to +150°F (-50° to +65°C)



 <p>Example of an L2A Construction</p>	 <p>Example of a C2A Construction</p>
---	---

Note 1: Insert desired S-T-C number in spaces marked XX.

Note 2: Upper use range is reduced to these values for stacked patterns.

General Purpose Strain Gages—Stacked Rosette

GAGE PATTERN DATA					
 <p style="text-align: center;">actual size</p>			GAGE DESIGNATION See Note 1	RESISTANCE (OHMS) 120 ± 0.6% 120 ± 0.6%	OPTIONS AVAILABLE
			L2A-XX-G1350-120/SP70* C2A-XX-G1350-120/SP70*		
DESCRIPTION Stacked, 0°-45°-90° rosette for use in applications involving limited gaging areas or steep strain gradients. The matrix has a circular trim (SP70).					
GAGE DIMENSIONS		Legend ES = Each Section CP = Complete Pattern S = Section (S1 = Section 1) M = Matrix			inch millimeter
Gage Length	Overall Length	Grid Width	Overall Width	Matrix Length	Matrix Width
0.040 ES	0.144 CP	0.045 ES	0.147 CP	0.20	0.20
1.0 ES	3.66 CP	1.14 ES	3.73 CP	5.1	5.1

GAGE SERIES DATA — See Gage Series datasheet for complete specifications			
Series	Description	Strain Range	Temperature Range
C2A	Encapsulated constantan gages with preattached ready-to-use cables.	±3%	-60° to +150°F (-50° to +66°C)
<div style="display: flex; justify-content: space-around; align-items: center;"> <div style="text-align: center;">  <p>Example of an L2A Construction</p> </div> <div style="text-align: center;">  <p>Example of an C2A Construction</p> </div> </div>			

Note 1: Insert desired S-T-C number in spaces marked XX.

*SP70: circular trim of matrix.

General Purpose Strain Gages – Rectangular Rosette

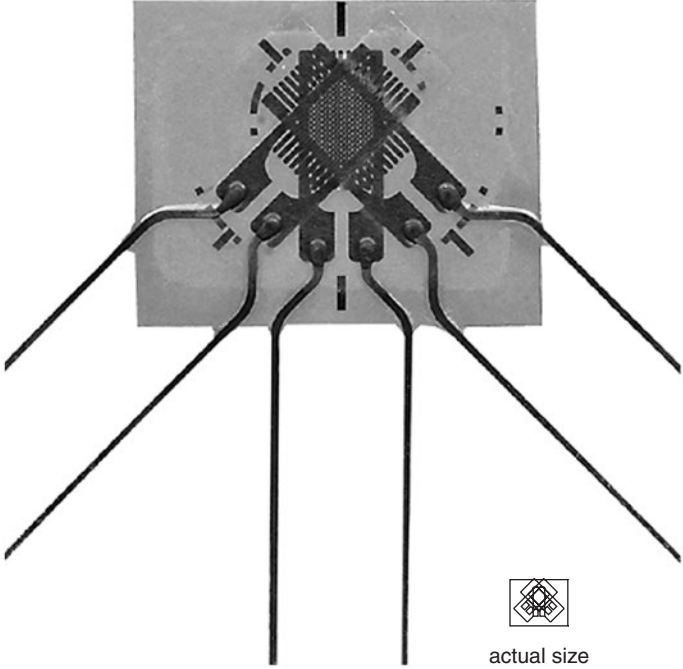

GAGE PATTERN DATA					
 <p style="text-align: center;">actual size</p>			GAGE DESIGNATION See Note 1, 2	RESISTANCE (OHMS)	OPTIONS AVAILABLE See Note 2
			WA-XX-060WR-120 WK-XX-060WR-120 WK-XX-060WR-350 WK-XX-060WR-10C SA-XX-060WR-120 SK-XX-060WR-120 SK-XX-060WR-350 SK-XX-060WR-10C	120 ± 0.5% 120 ± 0.5% 350 ± 0.5% 1000 ± 0.5% 120 ± 0.5% 120 ± 0.5% 350 ± 0.5% 1000 ± 0.5%	
DESCRIPTION Small three-element 45° rectangular stacked rosette					
GAGE DIMENSIONS		Legend ES = Each Section CP = Complete Pattern S = Section (S1 = Section 1) M = Matrix			
	inch				millimeter
Gage Length	Overall Length	Grid Width	Overall Width	Matrix Length	Matrix Width
0.060 ES	0.24 M	0.060 ES	0.30 M	0.24	0.30
1.52 ES	6.1 M	1.52 ES	7.6 M	6.1	7.6

GAGE SERIES DATA — See Gage Series datasheet for complete specifications			
Series	Description	Strain Range	Temperature Range
WA	Fully encapsulated constantan gages with high-endurance leadwires.	±2%	-100° to +400°F (-75° to +205°)
WK	Fully encapsulated K-alloy gages with high-endurance leadwires.	±1.5%	-452° to +550°F (-269° to +290°C)
SA	Fully encapsulated constantan gages with solder dots.	±2%	-100° to +400°F (-75° to +205°C)
SK	Fully encapsulated K-alloy gages with solder dots.	±1.5%	-452° to +450°F (-269° to +230°C)

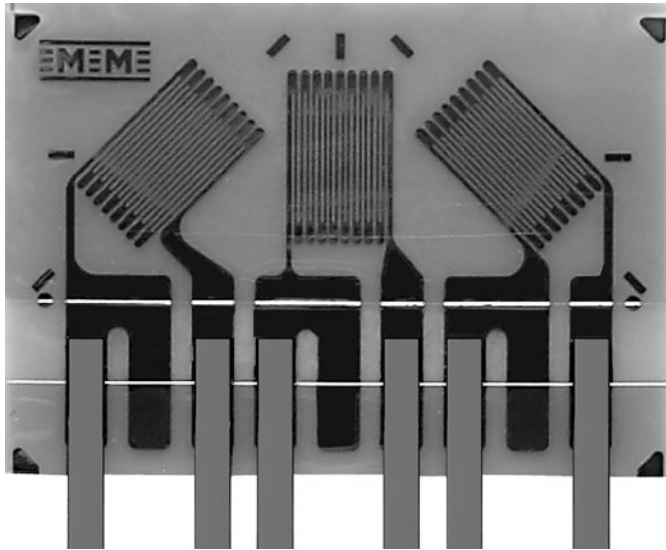

Note 1: Insert desired S-T-C number in spaces marked XX.

Note 2: Products with designations and options shown in bold are not RoHS compliant.

General Purpose Strain Gages – Rectangular Rosette

GAGE PATTERN DATA					
  actual size			GAGE DESIGNATION See Note 1	RESISTANCE (OHMS)	OPTIONS AVAILABLE
			L2A-XX-062LR-120 L2A-XX-062LR-350 C2A-XX062LR-120 C2A-XX-062LR-350	120 ± 0.6% 350 ± 0.6% 120 ± 0.6% 350 ± 0.6%	
DESCRIPTION Small 45° rectangular single-plane rosette.					 RoHS COMPLIANT
GAGE DIMENSIONS		Legend ES = Each Section S = Section (S1 = Section 1)			inch millimeter
Gage Length	Overall Length	Grid Width	Overall Width	Matrix Length	Matrix Width
0.062	0.185	0.050	0.260	0.277	0.410
1.52	4.70	1.27	6.60	7.04	10.41

GAGE SERIES DATA — See Gage Series datasheet for complete specifications			
Series	Description	Strain Range	Temperature Range
L2A	Encapsulated constantan gages with preattached ribbon leads.	±3%	-100° to +250°F (-75° to +120°C)
C2A	Encapsulated constantan gages with preattached ready-to-use cables.	±3%	-60° to +180°F (-50° to +80°C)

 <p>Example of an L2A Construction</p>	 <p>Example of an C2A Construction</p>
---	--

Note 1: Insert desired S-T-C number in spaces marked XX.

General Purpose Strain Gages – Rectangular Rosette

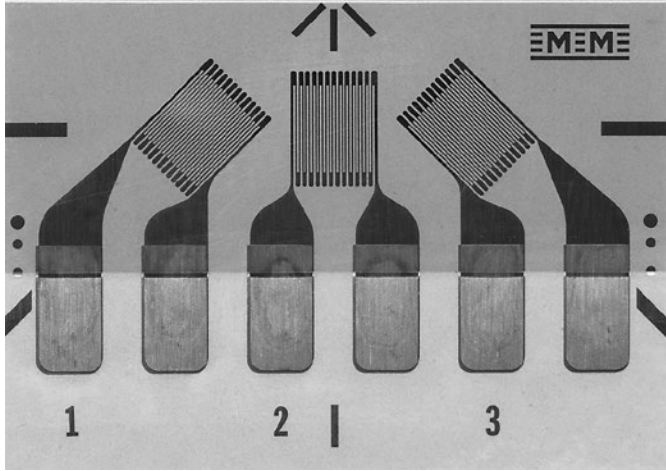

GAGE PATTERN DATA					
			GAGE DESIGNATION See Note 1	RESISTANCE (OHMS)	OPTIONS AVAILABLE See Note 2
			CEA-XX-062UR-120 CEA-XX-062UR-350	120 ± 0.4% 350 ± 0.4%	P2 P2
DESCRIPTION Small 45° rectangular single-plane rosette in a compact geometry. Exposed solder tab area 0.07 x 0.04 in (1.8 x 1.0 mm).					
GAGE DIMENSIONS		Legend ES = Each Section CP = Complete Pattern S = Section (S1 = Section 1) M = Matrix			<input type="checkbox"/> inch <input type="checkbox"/> millimeter
Gage Length	Overall Length	Grid Width	Overall Width	Matrix Length	Matrix Width
0.062 ES	0.222 CP	0.062 ES	0.420 CP	0.32	0.48
1.57 ES	5.64 CP	1.57 ES	10.67 CP	8.1	12.2

GAGE SERIES DATA — See Gage Series datasheet for complete specifications			
Series	Description	Strain Range	Temperature Range
CEA	Universal general-purpose strain gages.	±3%	-100° to +350°F (-75° to +175°C)

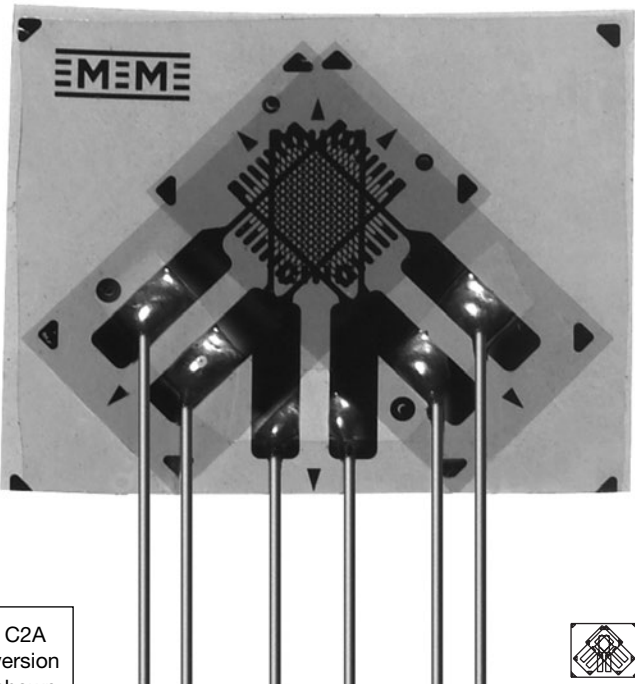

Note 1: Insert desired S-T-C number in spaces marked XX.

Note 2: Products with designations and options shown in bold are not RoHS compliant.

General Purpose Strain Gages—Stacked Rosette

GAGE PATTERN DATA					
			GAGE DESIGNATION See Note 1	RESISTANCE (OHMS)	OPTIONS AVAILABLE
			L2A-XX-062WW-120 L2A-XX-062WW-350 C2A-XX-062WW-120 C2A-XX-062WW-350	120 ± 0.6% 350 ± 0.6% 120 ± 0.6% 350 ± 0.6%	
DESCRIPTION Stacked, 0°-45°-90° rosette for use in applications involving limited gaging areas or steep strain gradients.					
GAGE DIMENSIONS		Legend ES = Each Section S = Section (S1 = Section 1)			inch millimeter
				CP = Complete Pattern	
				M = Matrix	
Gage Length	Overall Length	Grid Width	Overall Width	Matrix Length	Matrix Width
0.062 ES	0.180 CP	0.050 ES	0.235 CP	0.262	0.323
1.57 ES	4.57 CP	1.27 ES	6.00 CP	7.16	8.20

GAGE SERIES DATA — See Gage Series datasheet for complete specifications			
Series	Description	Strain Range	Temperature Range (See Note 2)
L2A	Encapsulated constantan gages with preattached ribbon leads.	±3%	-100° to +150°F (-75° to +65°C)
C2A	Encapsulated constantan gages with preattached ready-to-use cables.	±3%	-60° to +150°F (-50° to +65°C)

 <p>Example of an L2A Construction</p>	 <p>Example of an C2A Construction</p>
---	--

Note 1: Insert desired S-T-C number in spaces marked XX.

Note 2: Upper use range is reduced to these values for stacked patterns.

General Purpose Strain Gages – Rectangular Rosette

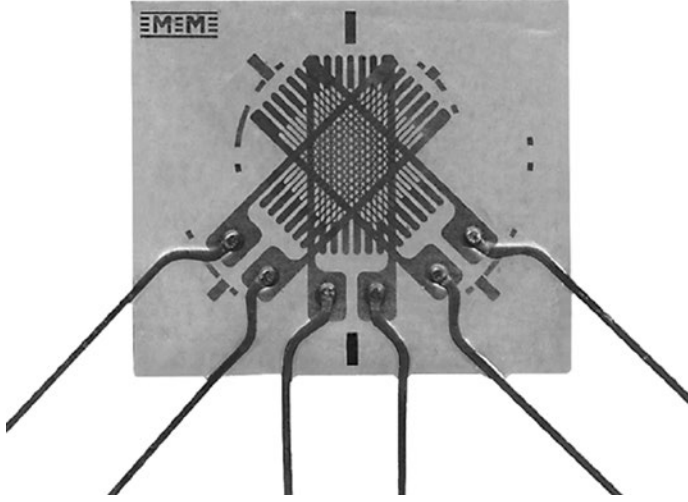
GAGE PATTERN DATA					
 <p style="text-align: center;">actual size</p>			GAGE DESIGNATION See Note 1, 3	RESISTANCE (OHMS) See Note 2	OPTIONS AVAILABLE See Note 3
			WA-XX-120WR-120 WA-XX-120WR-350 WD-DY-120WR-350 WK-XX-120WR-120 WK-XX-120WR-350 SA-XX-120WR-120 SA-XX-120WR-350 SK-XX-120WR-120 SK-XX-120WR-350 SD-DY-120WR-350	120 ± 0.5% 350 ± 0.5% 350 ± 0.5% 120 ± 0.5% 350 ± 0.5% 120 ± 0.5% 350 ± 0.5% 120 ± 0.5% 350 ± 0.5% 350 ± 0.5%	W W W* W W
DESCRIPTION Three-element 45° rectangular stacked rosette					
GAGE DIMENSIONS		Legend ES = Each Section CP = Complete Pattern S = Section (S1 = Section 1) M = Matrix			
				inch	
				millimeter	
Gage Length	Overall Length	Grid Width	Overall Width	Matrix Length	Matrix Width
0.120 ES	0.34 M	0.080 ES	0.040 M	0.34	0.40
3.05 ES	8.6 M	2.03 ES	10.2 M	8.6	10.2

GAGE SERIES DATA — See Gage Series datasheet for complete specifications			
Series	Description	Strain Range	Temperature Range
WA	Fully encapsulated constantan gages with high-endurance leadwires.	±2%	-100° to +400°F (-75° to +205°)
WD	Fully encapsulated isoelastic gages with high-endurance leadwires.	±1.5%	-320° to +500°F (-195° to +260°C)
WK	Fully encapsulated K-alloy gages with high-endurance leadwires.	±1.5%	-452° to +550°F (-269° to +290°C)
SA	Fully encapsulated constantan gages with solder dots.	±2%	-100° to +400°F (-75° to +205°C)
SK	Fully encapsulated K-alloy gages with solder dots.	±1.5%	-452° to +450°F (-269° to +230°C)
SD	Equivalent to WD Series, but with solder dots instead of leadwires.	±1.5%	-320° to +400°F (-195° to +205°C)



Note 1: Insert desired S-T-C number in spaces marked XX.

Note 2: Tolerance is increased when Option W, E, SE, LE, or P is specified.

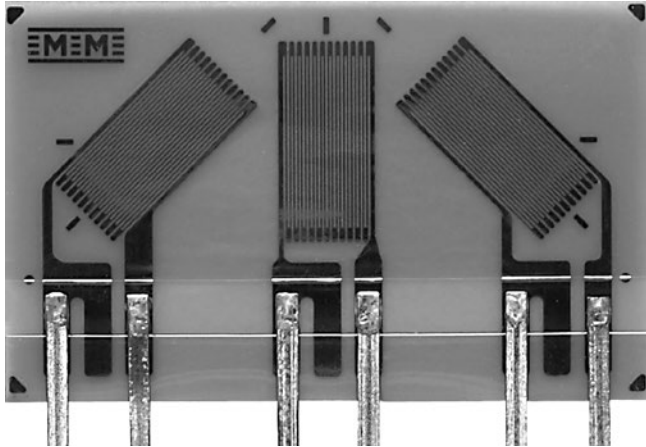
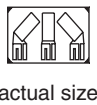

Note 3: Products with designations and options shown in **bold** are not RoHS compliant.

*Options available but not normally recommended. See Optional Features datasheet for details.

General Purpose Strain Gages – Rectangular Rosette



GAGE PATTERN DATA					
			GAGE DESIGNATION See Note 1	RESISTANCE (OHMS)	OPTIONS AVAILABLE
			L2A-XX-125LR-120 L2A-XX-125LR-350 C2A-XX-125LR-120 C2A-XX-125LR-350	120 ± 0.6% 350 ± 0.6% 120 ± 0.6% 350 ± 0.6%	
 <p>actual size</p>			DESCRIPTION General-purpose 45° rectangular single-plane rosette.		
GAGE DIMENSIONS		Legend ES = Each Section S = Section (S1 = Section 1)			inch millimeter
				CP = Complete Pattern	
				M = Matrix	
Gage Length	Overall Length	Grid Width	Overall Width	Matrix Length	Matrix Width
0.125	0.245	0.070	0.415	0.290	0.475
3.18	6.22	1.78	10.54	7.37	12.06

GAGE SERIES DATA — See Gage Series datasheet for complete specifications			
Series	Description	Strain Range	Temperature Range
L2A	Encapsulated constantan gages with preattached ribbon leads.	±3%	-100° to +250°F (-75° to +120°C)
C2A	Encapsulated constantan gages with preattached ready-to-use cables.	±3%	-60° to +180°F (-50° to +80°C)

 <p>Example of an L2A Construction</p>	 <p>Example of an C2A Construction</p>
---	--

Note 1: Insert desired S-T-C number in spaces marked XX.

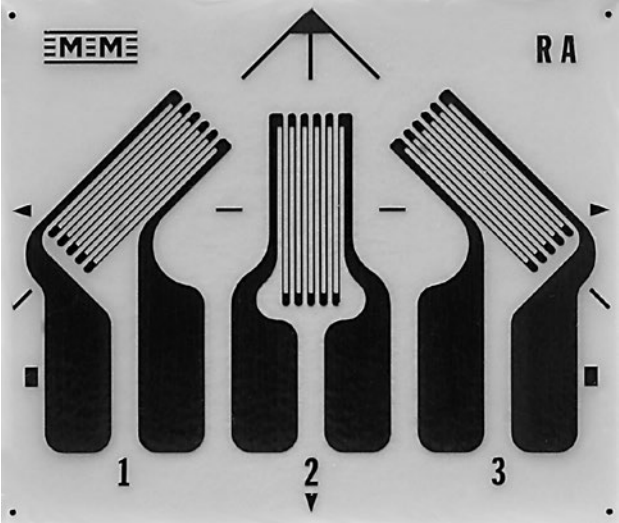
General Purpose Strain Gages – Rectangular Rosette

GAGE PATTERN DATA					
			GAGE DESIGNATION See Note 1, 3	RESISTANCE (OHMS) See Note 2	OPTIONS AVAILABLE See Note 3
			EA-XX-125RA-120 EK-XX-125RA-350* WA-XX-125RA-120 WK-XX-125RA-350 EP-08-125RA-120 SA-XX-125RA-120 SK-XX-125RA-350	120 ± 0.2% 350 ± 0.2% 120 ± 0.4% 350 ± 0.4% 120 ± 0.2% 120 ± 0.4% 350 ± 0.4%	W, E, L, LE W, SE W** W**
 actual size			DESCRIPTION General-purpose three-element 45° rectangular rosette. Compact geometry. See also 125RD and 125UR patterns.		
GAGE DIMENSIONS		Legend ES = Each Section CP = Complete Pattern S = Section (S1 = Section 1) M = Matrix			
					<input type="checkbox"/> inch <input type="checkbox"/> millimeter
Gage Length	Overall Length	Grid Width	Overall Width	Matrix Length	Matrix Width
0.125 ES	0.275 CP	0.062 ES	0.424 CP	0.39	0.46
3.18 ES	6.99 CP	1.57 ES	10.77 CP	9.9	11.7

GAGE SERIES DATA — See Gage Series datasheet for complete specifications			
Series	Description	Strain Range	Temperature Range
EA	Constantan foil in combination with a tough, flexible, polyimide backing.	±3%	-100° to +350°F (-75° to +175°C)
EK	K-alloy foil in combination with a tough, flexible polyimide backing.	±1.5%	-320° to +350°F (-195° to +175°C)
WA	Fully encapsulated constantan gages with high-endurance leadwires.	±2%	-100° to +400°F (-75° to +205°)
WK	Fully encapsulated K-alloy gages with high-endurance leadwires.	±1.5%	-452° to +550°F (-269° to +290°C)
EP	Annealed constantan foil with tough, high-elongation polyimide backing.	±20%	-100° to +400°F (-75° to +205°C)
SA	Fully encapsulated constantan gages with solder dots.	±2%	-100° to +400°F (-75° to +205°C)
SK	Fully encapsulated K-alloy gages with solder dots.	±1.5%	-452° to +450°F (-269° to +230°C)

Note 1: Insert desired S-T-C number in spaces marked XX.

Note 2: Tolerance is increased when Option W, E, SE, LE, or P is specified.

Note 3: Products with designations and options shown in **bold** are not RoHS compliant.

* EK-Series gages are supplied with duplex copper pads (DP) when optional feature W or SE is not specified.

** Options available but not normally recommended. See Optional Features datasheet for details.

General Purpose Strain Gages – Rectangular Rosette

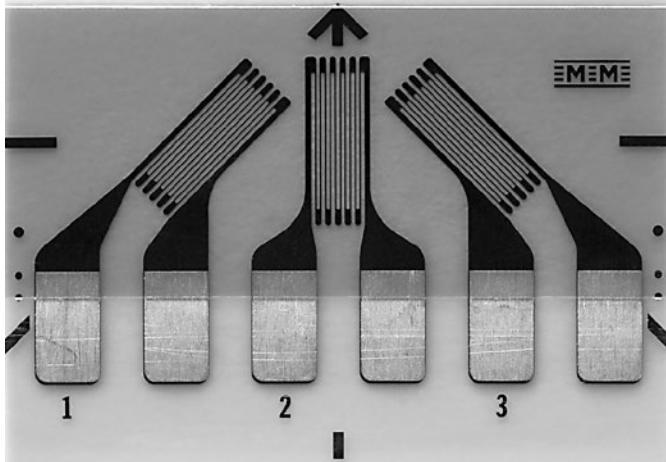
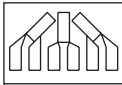

GAGE PATTERN DATA							
			GAGE DESIGNATION See Note 1	RESISTANCE (OHMS)	OPTIONS AVAILABLE See Note 2		
			CEA-XX-125UR-120 CEA-XX-125UR-350	120 ± 0.4% 350 ± 0.4%	P2 P2		
 <p>actual size</p>			DESCRIPTION General-purpose 45° single-plane rosette. Compact geometry. Exposed solder tab area 0.08 x 0.06 in (2.0 x 1.5 mm).				
GAGE DIMENSIONS		Legend ES = Each Section CP = Complete Pattern S = Section (S1 = Section 1) M = Matrix					
				<table border="1"> <tr><td>inch</td></tr> <tr><td>millimeter</td></tr> </table>	inch	millimeter	
inch							
millimeter							
Gage Length	Overall Length	Grid Width	Overall Width	Matrix Length	Matrix Width		
0.125 ES	0.300 CP	0.060 ES	0.560 CP	0.42	0.62		
3.18 ES	7.62 CP	1.52 ES	14.22 CP	10.7	15.7		

GAGE SERIES DATA — See Gage Series datasheet for complete specifications			
Series	Description	Strain Range	Temperature Range
CEA	Universal general-purpose strain gages.	±5%	-100° to +350°F (-75° to +175°C)

Note 1: Insert desired S-T-C number in spaces marked XX.

Note 2: Products with designations and options shown in bold are not RoHS compliant.

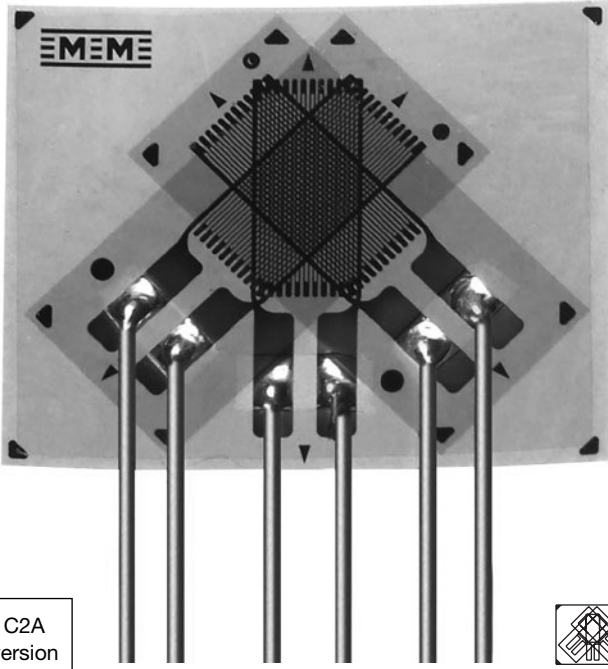
General Purpose Strain Gages—Stacked Rosette

GAGE PATTERN DATA					
 <p>C2A version shown</p> <p>actual size</p>			GAGE DESIGNATION See Note 1	RESISTANCE (OHMS)	OPTIONS AVAILABLE
			L2A-XX-125WW-120 L2A-XX-125WW-350 C2A-XX-125WW-120 C2A-XX-125WW-350	120 ± 0.6% 350 ± 0.6% 120 ± 0.6% 350 ± 0.6%	
DESCRIPTION Stacked, 0°-45°-90° rosette for use in applications involving limited gaging areas or steep strain gradients.					
GAGE DIMENSIONS		Legend ES = Each Section S = Section (S1 = Section 1) CP = Complete Pattern M = Matrix			<input type="checkbox"/> inch <input checked="" type="checkbox"/> millimeter
Gage Length	Overall Length	Grid Width	Overall Width	Matrix Length	Matrix Width
0.125 ES	0.241 CP	0.070 ES	0.280 CP	0.309	0.375
3.18 ES	6.12 CP	1.78 ES	7.11 CP	7.85	9.53

GAGE SERIES DATA — See Gage Series datasheet for complete specifications

Series	Description	Strain Range	Temperature Range
L2A	Encapsulated constantan gages with preattached ribbon leads.	±3%	-100° to +150°F (-75° to +65°C)
C2A	Encapsulated constantan gages with preattached ready-to-use cables.	±3%	-60° to +150°F (-50° to +65°C)



Example of an L2A Construction







Example of an C2A Construction

Note 1: Insert desired S-T-C number in spaces marked XX.

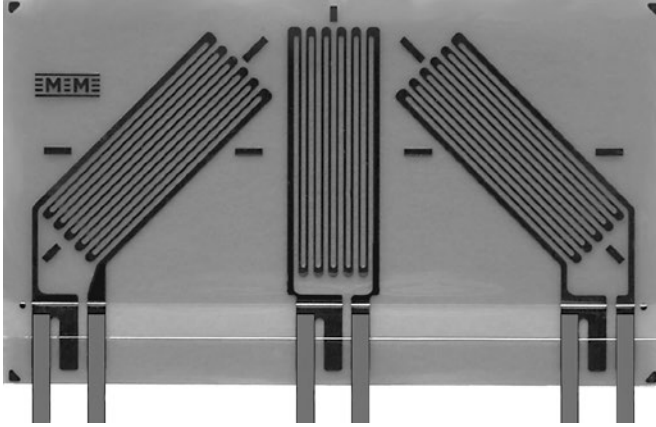
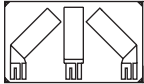
Note 2: Upper use range is reduced to these values for stacked patterns.

General Purpose Strain Gages – Rectangular Rosette

GAGE PATTERN DATA					
			GAGE DESIGNATION See Note 1	RESISTANCE (OHMS)	OPTIONS AVAILABLE
			L2A-XX-250LR-120 L2A-XX-250LR-350 C2A-XX-250LR-120 C2A-XX-250LR-350	120 ± 0.6% 350 ± 0.6% 120 ± 0.6% 350 ± 0.6%	
 <p>actual size</p>			DESCRIPTION General-purpose 45° rectangular single-plane rosette.		 RoHS COMPLIANT
GAGE DIMENSIONS		Legend ES = Each Section CP = Complete Pattern S = Section (S1 = Section 1) M = Matrix			inch millimeter
Gage Length	Overall Length	Grid Width	Overall Width	Matrix Length	Matrix Width
0.250	0.373	0.100	0.655	0.420	0.715
6.35	9.47	2.54	16.64	10.67	18.16
GAGE SERIES DATA — See Gage Series datasheet for complete specifications					
Series	Description	Strain Range	Temperature Range		
L2A	Encapsulated constantan gages with preattached ribbon leads.	±3%	-100° to +250°F (-75° to +120°C)		
C2A	Encapsulated constantan gages with preattached ready-to-use cables.	±3%	-60° to +180°F (-50° to +80°C)		
 <p>Example of an L2A Construction</p>		 <p>Example of an C2A Construction</p>			

Note 1: Insert desired S-T-C number in spaces marked XX.

General Purpose Strain Gages – Rectangular Rosette

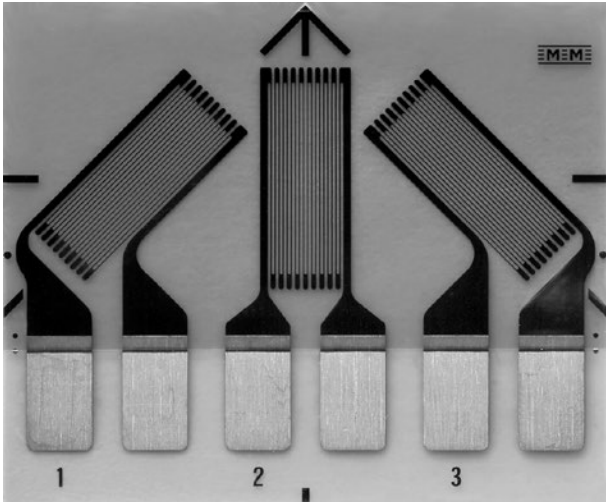
GAGE PATTERN DATA					
			GAGE DESIGNATION See Note 1	RESISTANCE (OHMS)	OPTIONS AVAILABLE See Note 2
			CEA-XX-250UR-120 CEA-XX-250UR-350	120 ± 0.4% 350 ± 0.4%	P2 P2
DESCRIPTION Large three-element 45° single-plane rosette. Exposed solder tab area 0.13 x 0.08 in [3.3 x 2.0 mm].					
GAGE DIMENSIONS		Legend			<input type="checkbox"/> inch <input type="checkbox"/> millimeter
		ES = Each Section S = Section (S1 = Section 1)			CP = Complete Pattern M = Matrix
Gage Length	Overall Length	Grid Width	Overall Width	Matrix Length	Matrix Width
0.250 ES	0.500 CP	0.120 ES	0.760 CP	0.65	0.80
6.35 ES	12.70 CP	3.05 ES	19.30 CP	16.5	20.3



GAGE SERIES DATA — See Gage Series datasheet for complete specifications

Series	Description	Strain Range	Temperature Range
CEA	Universal general-purpose strain gages.	±5%	-100° to +350°F (-75° to +175°C)

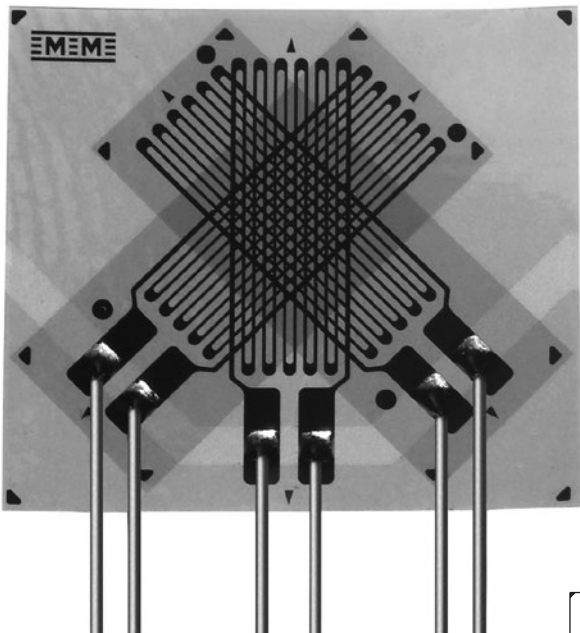

Note 1: Insert desired S-T-C number in spaces marked XX.

Note 2: Products with designations and options shown in bold are not RoHS compliant.

General Purpose Strain Gages—Stacked Rosette

GAGE PATTERN DATA					
		GAGE DESIGNATION See Note 1	RESISTANCE (OHMS)	OPTIONS AVAILABLE	
		L2A-XX-250WW-120 L2A-XX-250WW-350 C2A-XX-250WW-120 C2A-XX-250WW-350	120 ± 0.6% 350 ± 0.6% 120 ± 0.6% 350 ± 0.6%		
		DESCRIPTION Stacked, 0°-45°-90° rosette for use in applications involving limited gaging areas or steep strain gradients.			
GAGE DIMENSIONS		Legend ES = Each Section S = Section (S1 = Section 1) CP = Complete Pattern M = Matrix			<input type="checkbox"/> inch <input type="checkbox"/> millimeter
Gage Length	Overall Length	Grid Width	Overall Width	Matrix Length	Matrix Width
0.250 ES	0.362 CP	0.100 ES	0.375 CP	0.418	0.477
6.35 ES	9.19 CP	2.54 ES	9.53 CP	10.62	12.12











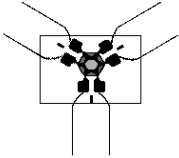

GAGE SERIES DATA — See Gage Series datasheet for complete specifications			
Series	Description	Strain Range	Temperature Range
L2A	Encapsulated constantan gages with preattached ribbon leads.	±3%	-100° to +150°F (-75° to +65°C)
C2A	Encapsulated constantan gages with preattached ready-to-use cables.	±3%	-60° to +150°F (-50° to +65°C)

 <p>Example of an L2A Construction</p>	 <p>Example of an C2A Construction</p>
---	--

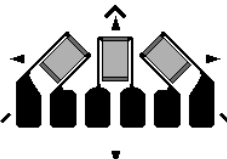
Note 1: Insert desired S-T-C number in spaces marked XX.

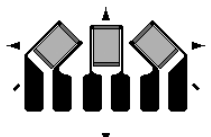
Note 2: Upper use range is reduced to these values for stacked patterns.

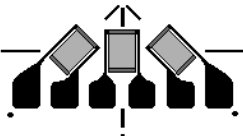







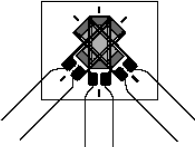

General Purpose Strain Gages

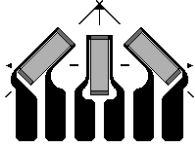
GAGE PATTERN	GAGE SERIES See Note 1	GAGE RESISTANCE (OHMS)	GAGE LENGTH	
			inches	millimeters
015RC   actual size	EA, SA	120	0.015	0.38
	Micro-miniature three-element 45° rosette with one tab common to all sections. See also 015RJ pattern. Note: See Strip Patterns datasheet for discussion of common-tab gages. Matrix size: 0.18L x 0.23W in. (4.6L x 5.8W mm)			
015RJ   actual size	EA, SA	120	0.015	0.38
	Micro-miniature three-element 45° rosette. Similar to 015RC pattern except each section has separate tabs for electrical isolation. Matrix size: 0.19L x 0.23W in. (4.8L x 5.8W mm)			
030WR   actual size	WA, WK, SA, SK	120	0.03	0.76
	Miniature three-element 45° rectangular stacked rosette. Matrix size: 0.18L x 0.19W in. (4.6L x 4.8W mm)			
031RB   actual size	EA, EP, SA	120	0.031	0.79
	Miniature 45° rectangular single-plane rosette with compact geometry. Matrix size: 0.19L x 0.24W in. (4.8L x 6.1W mm)			
062RB   actual size	EA, WA, WK, EP, SA, SK	120, 350	0.062	1.57
	Small 45° rectangular single-plane rosette with compact geometry. Matrix size: 0.42L x 0.46W in. (10.7L x 11.7W mm)			
062RF   actual size	EA, SA	350	0.062	1.57
	Small 45° rectangular single-plane rosette designed for use with Option W. Matrix size: 0.25L x 0.46W in. (6.4L x 11.7W mm)			

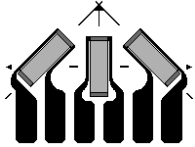
Note 1: Products with designations and options shown in **bold** are not RoHS compliant.

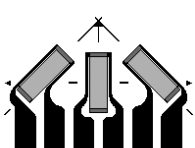
See <http://www.vishaypg.com/micro-measurements/stress-analysis-strain-gages/other-rectangular-rosettes/> for complete specifications.

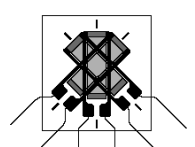
General Purpose Strain Gages

GAGE PATTERN	GAGE SERIES See Note 1	GAGE RESISTANCE (OHMS)	GAGE LENGTH	
			inches	millimeters
120WR   actual size	WA, WD, WK, SA, SK, SD	120, 350	0.12	3.05
Three-element 45° rectangular stacked rosette. Matrix size: 0.34L x 0.40W in. (8.6L x 10.2W mm)				
125RD   actual size	EA, WA, SA	350	0.125	3.18
General-purpose three-element 45° rectangular rosette. Similar to 125RA pattern except for grid resistance. Matrix size: 0.40L x 0.47W in. (10.1L x 11.9W mm)				
250RA   actual size	EA, WA, WK, EP, SA, SK	120, 350	0.25	6.35
Large three-element 45° rectangular rosette with convenient solder tab arrangement. See also 250RD pattern. Matrix size: 0.78L x 0.93W in. (19.8L x 23.6W mm)				
250RD   actual size	EA, EK, S2K, WA, WK, EP, SA, SK	350, 1000	0.25	6.35
Large three-element 45° rectangular rosette. Similar to the 250RA pattern except for resistance. EK-Series gages are supplied with duplex copper pads (DP) when optional feature W or SE is not specified. Matrix size: 0.78L x 0.93W in. (19.8L x 23.6W mm)				
250WR   actual size	WA, WD, WK, SA, SK, SD	120, 350	0.25	6.35
Three-element 45° rectangular stacked rosette. Matrix size: 0.51L x 0.60W in. (13.0L x 15.2W mm)				

Note 1: Products with designations and options shown in **bold** are not RoHS compliant.







See <http://www.vishaypg.com/micro-measurements/stress-analysis-strain-gages/other-rectangular-rosettes/> for complete specifications.

Delta Rosettes (General-Use)

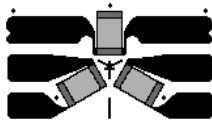
FEATURES

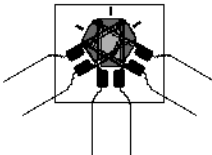
- Gage patterns designed for determining principle stresses and strains
- All patterns have three grids oriented at 0°, 60° and 120° angles
- Both stacked and planar constructions available
- Gage lengths from 0.30" (0.76 mm) to 0.125" (3.18 mm)

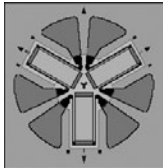
General Purpose Strain Gages

GAGE PATTERN	GAGE SERIES See Note 1	GAGE RESISTANCE (OHMS)	GAGE LENGTH	
			inches	millimeters
030YB   actual size	EA, SA	120	0.03	0.76
	Miniature three-element 60° delta single-plane rosette. Matrix size: 0.21L x 0.27W in. (5.3L x 6.9W mm)			
060WY   actual size	WA, WK, SA, SK	120, 350, 1000	0.06	1.52
	Small three-element 60° delta stacked rosette. Matrix size: 0.24L x 0.30W in. (6.1L x 7.6W mm)			
125UY   actual size	CEA	120, 350	0.125	3.18
	Three-element 60° delta single-plane rosette. Matrix size: 0.50L x 0.44W in. (12.7L x 11.2W mm)			

Note 1: Products with designations and options shown in **bold** are not RoHS compliant.

See <http://www.micro-measurements.com/stress-analysis-strain-gages/delta-rosettes/> for complete specifications.

Shear/Torque Rosettes (General-Use)

FEATURES

- Gage patterns designed for measuring shear strain and torque
- Individual and multiple grid patterns
- Gage lengths from 0.062" (1.57 mm) to 0.250" (6.35 mm)

PATTERNS

062DY	106
062LV	107
062TH	108
062TV	109
062UV	110
125TK	111
187UV	112
250US	113
Other Shear/Torque Patterns	114

General Purpose Strain Gages – Shear/ Torque Pattern

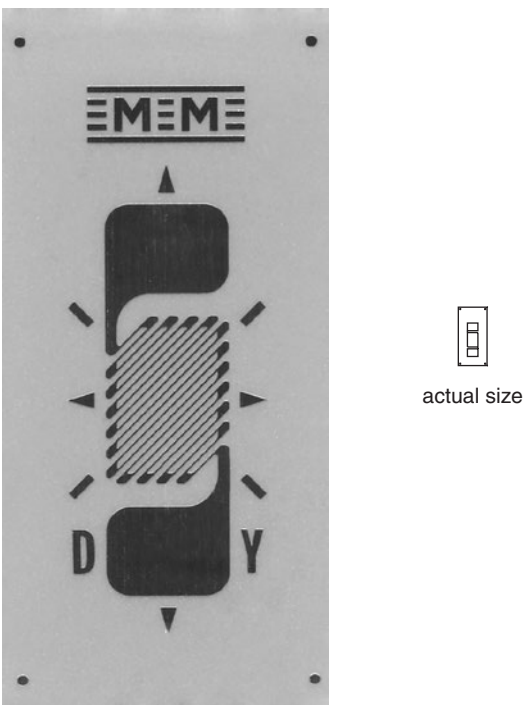
GAGE PATTERN DATA					
		GAGE DESIGNATION See Note 1, 3	RESISTANCE (OHMS) See Note 2	OPTIONS AVAILABLE See Note 3	
		EA-XX-062DY-120 ED-DY-062DY-350 WA-XX-062DY-120 WK-XX-062DY-350 SA-XX-062DY-350 SK-XX-062DY-350 SD-DY-062DY-350 WD-DY-062DY-350	120 ± 0.15% 350 ± 0.4% 120 ± 0.3% 350 ± 0.3% 120 ± 0.3% 350 ± 0.3% 350 ± 0.8% 350 ± 0.8%	E, L, LE E, L*, LE*	
DESCRIPTION 45° torque gage. Similar to 062DW pattern but with opposite grid angle.					
GAGE DIMENSIONS		Legend ES = Each Section CP = Complete Pattern S = Section (S1 = Section 1) M = Matrix			
				inch millimeter	
Gage Length	Overall Length	Grid Width	Overall Width	Matrix Length	Matrix Width
0.062	0.175	0.055	0.055	0.30	0.15
1.57	4.45	1.40	1.40	7.6	3.8

GAGE SERIES DATA — See Gage Series datasheet for complete specifications			
Series	Description	Strain Range	Temperature Range
EA	Constantan foil in combination with a tough, flexible, polyimide backing.	±3%	-100° to +350°F (-75° to +175°C)
ED	Isoelastic foil in combination with tough, flexible polyimide film.	±2%	-320° to +400°F (-195° to +205°C)
WA	Fully encapsulated constantan gages with high-endurance leadwires.	±2%	-100° to +400°F (-75° to +205°)
WK	Fully encapsulated K-alloy gages with high-endurance leadwires.	±1.5%	-452° to +550°F (-269° to +290°C)
SA	Fully encapsulated constantan gages with solder dots.	±2%	-100° to +400°F (-75° to +205°C)
SK	Fully encapsulated K-alloy gages with solder dots.	±1.5%	-452° to +450°F (-269° to +230°C)
SD	Equivalent to WD Series, but with solder dots instead of leadwires.	±1.5%	-320° to +400°F (-195° to +205°C)
WD	Fully encapsulated isoelastic gages with high-endurance leadwires.	±1.5%	-320° to +500°F (-195° to +260°C)



Note 1: Insert desired S-T-C number in spaces marked XX.

Note 2: Tolerance is increased when Option W, E, SE, LE, or P is specified.

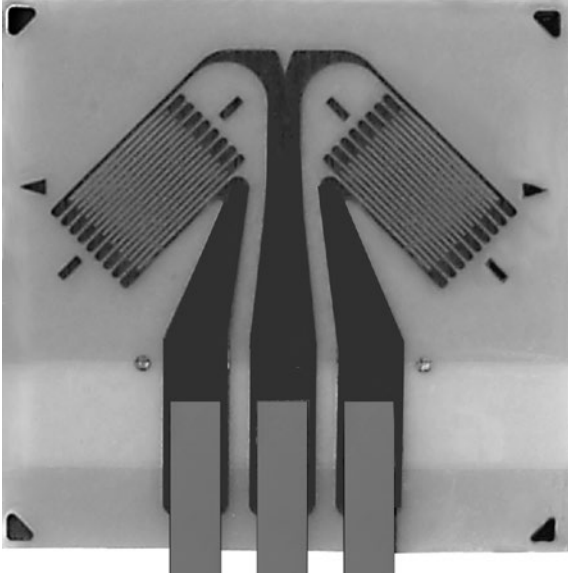

Note 3: Products with designations and options shown in **bold** are not RoHS compliant.

*Options available but not normally recommended. See Optional Features datasheet for details.

General Purpose Strain Gages – Shear/ Torque Pattern



GAGE PATTERN DATA					
  actual size			GAGE DESIGNATION See Note 1	RESISTANCE (OHMS)	OPTIONS AVAILABLE
			L2A-XX-062LV-120 C2A-XX-062LV-120	120 ± 0.6% 120 ± 0.6%	
DESCRIPTION Two-element 90° torque gage.					
GAGE DIMENSIONS		Legend ES = Each Section S = Section (S1 = Section 1)			inch millimeter
				CP = Complete Pattern	
				M = Matrix	
Gage Length	Overall Length	Grid Width	Overall Width	Matrix Length	Matrix Width
0.062 ES	0.214 CP	0.050 ES	0.215 CP	0.255	0.265
1.52 ES	5.44 CP	1.27 ES	5.46 CP	6.48	6.73

GAGE SERIES DATA — See Gage Series datasheet for complete specifications			
Series	Description	Strain Range	Temperature Range
L2A	Encapsulated constantan gages with preattached ribbon leads.	±3%	-100° to +250°F (-75° to +120°C)
C2A	Encapsulated constantan gages with preattached ready-to-use cables.	±3%	-60° to +180°F (-50° to +80°C)

 Example of an L2A Construction	 Example of an C2A Construction
---	--

Note 1: Insert desired S-T-C number in spaces marked XX.

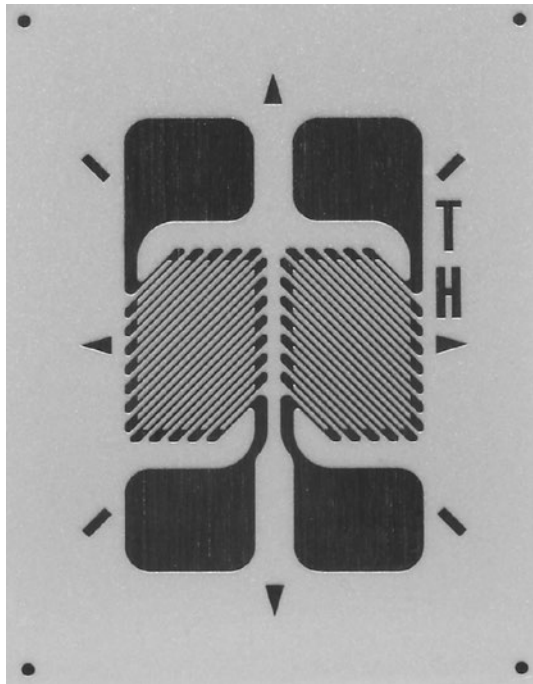
General Purpose Strain Gages – Shear/ Torque Pattern

GAGE PATTERN DATA							
		GAGE DESIGNATION See Note 1, 3		RESISTANCE (OHMS) See Note 2	OPTIONS AVAILABLE See Note 3		
		EA-XX-062TH-120 SA-XX-062TH-120 SK-XX-062TH-350		120 ± 0.2% 120 ± 0.4% 350 ± 0.4%	E, L, LE		
		 actual size					
DESCRIPTION Two-element 90° torque gage. Sections are electrically independent. See also 062TV and 062TW patterns.							
GAGE DIMENSIONS			Legend ES = Each Section CP = Complete Pattern S = Section (S1 = Section 1) M = Matrix				
				<table border="1"> <tr><td>inch</td></tr> <tr><td>millimeter</td></tr> </table>	inch	millimeter	
inch							
millimeter							
Gage Length	Overall Length	Grid Width	Overall Width	Matrix Length	Matrix Width		
0.062 ES	0.175 CP	0.055 ES	0.115 CP	0.27	0.21		
1.57 ES	4.45 CP	1.40 ES	2.92 CP	6.9	5.3		

GAGE SERIES DATA — See Gage Series datasheet for complete specifications			
Series	Description	Strain Range	Temperature Range
EA	Constantan foil in combination with a tough, flexible, polyimide backing.	±3%	-100° to +350°F (-75° to +175°C)
SA	Fully encapsulated constantan gages with solder dots.	±2%	-100° to +400°F (-75° to +205°C)
SK	Fully encapsulated K-alloy gages with solder dots.	±1.5%	-452° to +450°F (-269° to +230°C)

Note 1: Insert desired S-T-C number in spaces marked XX.

Note 2: Tolerance is increased when Option W, E, SE, LE, or P is specified.

Note 3: Products with designations and options shown in **bold** are not RoHS compliant.

General Purpose Strain Gages – Shear/ Torque Pattern

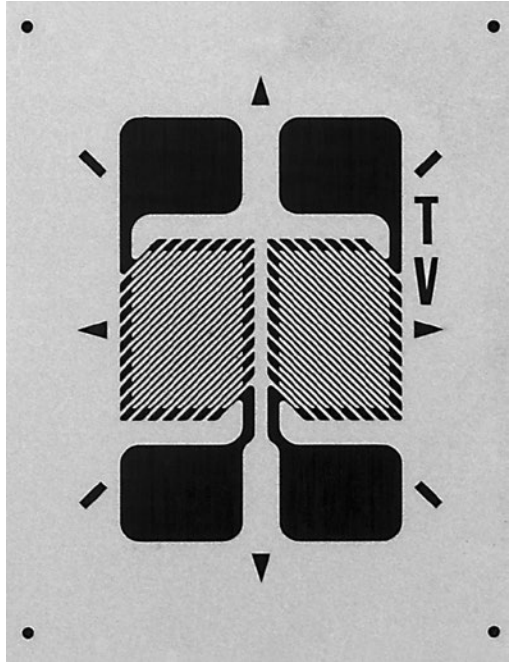
GAGE PATTERN DATA					
		GAGE DESIGNATION See Note 1, 3	RESISTANCE (OHMS) See Note 2	OPTIONS AVAILABLE See Note 3	
		EA-XX-062TV-350 SA-XX-062TV-350 SK-XX-062TV-500	350 ± 0.2% 350 ± 0.4% 500 ± 0.4%	E, L, LE	
		DESCRIPTION Two-element 90° torque gage.			
GAGE DIMENSIONS		Legend			<input type="checkbox"/> inch <input type="checkbox"/> millimeter
		ES = Each Section S = Section (S1 = Section 1)			CP = Complete Pattern M = Matrix
Gage Length	Overall Length	Grid Width	Overall Width	Matrix Length	Matrix Width
0.062 ES	0.175 CP	0.055 ES	0.115 CP	0.27	0.21
1.57 ES	4.45 CP	1.40 ES	2.92 CP	6.9	5.3

GAGE SERIES DATA — See Gage Series datasheet for complete specifications			
Series	Description	Strain Range	Temperature Range
EA	Constantan foil in combination with a tough, flexible, polyimide backing.	±3%	-100° to +350°F (-75° to +175°C)
SA	Fully encapsulated constantan gages with solder dots.	±2%	-100° to +400°F (-75° to +205°C)
SK	Fully encapsulated K-alloy gages with solder dots.	±1.5%	-452° to +450°F (-269° to +230°C)

Note 1: Insert desired S-T-C number in spaces marked XX.

Note 2: Tolerance is increased when Option W, E, SE, LE, or P is specified.

Note 3: Products with designations and options shown in **bold** are not RoHS compliant.

General Purpose Strain Gages – Shear/ Torque Pattern

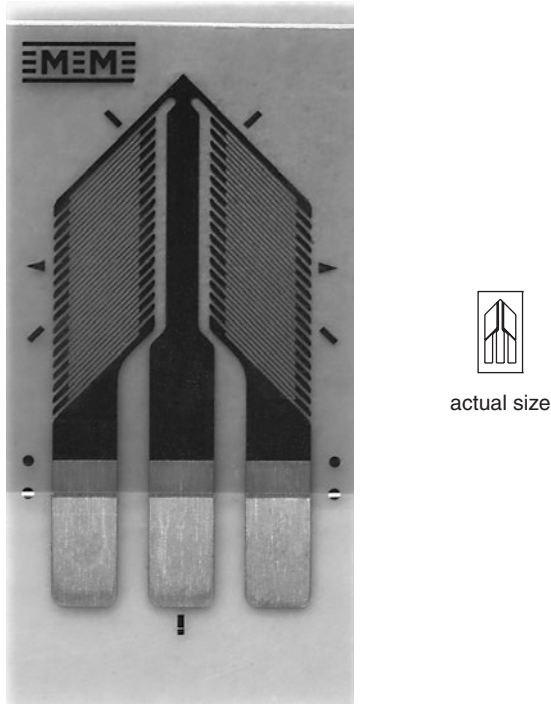
GAGE PATTERN DATA					
			GAGE DESIGNATION See Note 1	RESISTANCE (OHMS)	OPTIONS AVAILABLE See Note 2
			CEA-XX-062UV-350 CEA-XX-062UV-500	350 ± 0.4% 500 ± 0.4%	P2
DESCRIPTION Two-element 90° rosette for torque and shear-strain measurement. Sections have a common electrical connection. Exposed solder tab area is 0.04 x 0.07 in [1.0 x 1.8 mm].					
GAGE DIMENSIONS		Legend ES = Each Section CP = Complete Pattern S = Section (S1 = Section 1) M = Matrix			
				<input type="checkbox"/> inch <input type="checkbox"/> millimeter	
Gage Length	Overall Length	Grid Width	Overall Width	Matrix Length	Matrix Width
0.062 ES	0.330 CP	0.063 ES	0.160 CP	0.42	0.23
1.57 ES	8.38 CP	1.60 ES	4.06 CP	10.7	5.8

GAGE SERIES DATA — See Gage Series datasheet for complete specifications			
Series	Description	Strain Range	Temperature Range
CEA	Universal general-purpose strain gages.	±3%	-100° to +350°F (-75° to +175°C)

Note 1: Insert desired S-T-C number in spaces marked XX.

Note 2: Products with designations and options shown in bold are not RoHS compliant.

General Purpose Strain Gages – Shear/ Torque Pattern

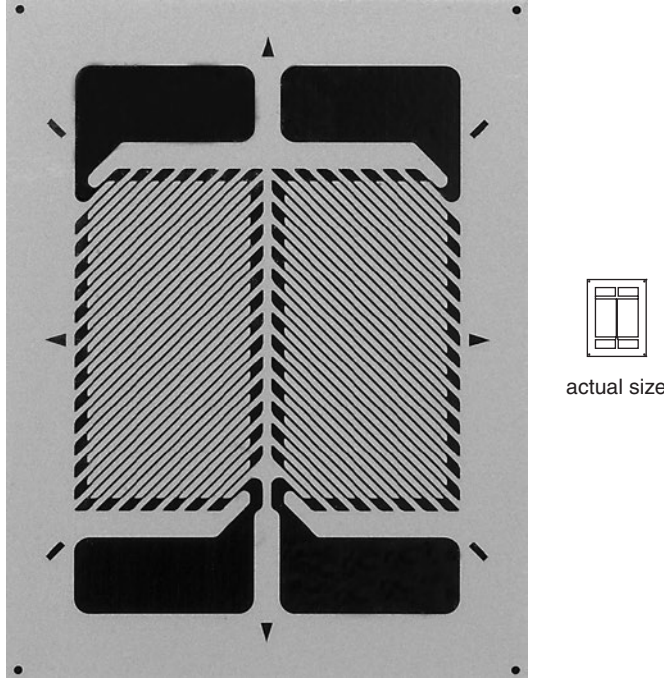
GAGE PATTERN DATA					
 <p>actual size</p>		GAGE DESIGNATION See Note 1, 3	RESISTANCE (OHMS) See Note 2	OPTIONS AVAILABLE See Note 3	
		EA-XX-125TK-350 WA-XX-125TK-350 WK-XX-125TK-10C SA-XX-125TK-350 SK-XX-125TK-10C	350 ± 0.2% 350 ± 0.4% 1000 ± 0.4% 350 ± 0.4% 1000 ± 0.4%	E, L, LE	
DESCRIPTION High-resistance two-element 90° torque gage. Similar to 125TL pattern except sections are electrically independent. See also 125TH pattern.					
GAGE DIMENSIONS		Legend			<input type="checkbox"/> inch <input type="checkbox"/> millimeter
		ES = Each Section S = Section (S1 = Section 1)			
		CP = Complete Pattern M = Matrix			
Gage Length	Overall Length	Grid Width	Overall Width	Matrix Length	Matrix Width
0.125 ES	0.320 CP	0.110 ES	0.225 CP	0.40	0.31
3.18 ES	8.13 CP	2.79 ES	5.72 CP	10.2	7.9

GAGE SERIES DATA — See Gage Series datasheet for complete specifications			
Series	Description	Strain Range	Temperature Range
EA	Constantan foil in combination with a tough, flexible, polyimide backing.	±5%	-100° to +350°F (-75° to +175°C)
WA	Fully encapsulated constantan gages with high-endurance leadwires.	±2%	-100° to +400°F (-75° to +205°)
WK	Fully encapsulated K-alloy gages with high-endurance leadwires.	±1.5%	-452° to +550°F (-269° to +290°C)
SA	Fully encapsulated constantan gages with solder dots.	±2%	-100° to +400°F (-75° to +205°C)
SK	Fully encapsulated K-alloy gages with solder dots.	±1.5%	-452° to +450°F (-269° to +230°C)

Note 1: Insert desired S-T-C number in spaces marked XX.

Note 2: Tolerance is increased when Option W, E, SE, LE, or P is specified.

Note 3: Products with designations and options shown in **bold** are not RoHS compliant.

General Purpose Strain Gages – Shear/ Torque Pattern

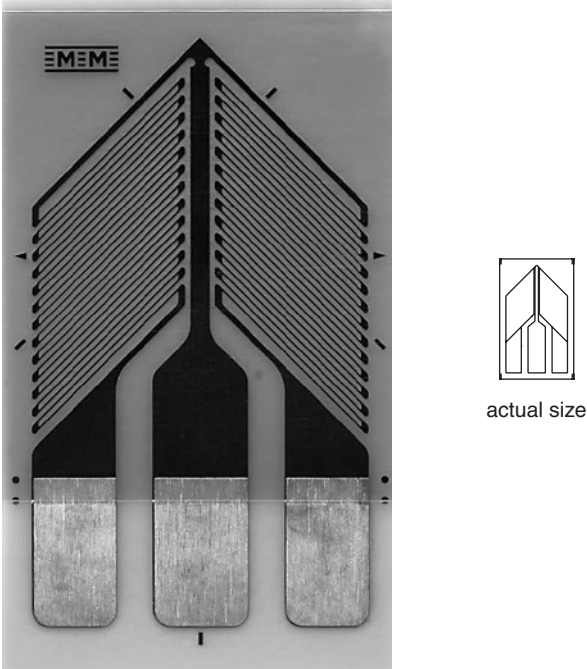
GAGE PATTERN DATA					
		GAGE DESIGNATION See Note 1	RESISTANCE (OHMS)	OPTIONS AVAILABLE See Note 2	
		CEA-XX-187UV-120 CEA-XX-187UV-350	120 ± 0.4% 350 ± 0.4%	P2 P2	
DESCRIPTION Two-element 90° rosette for torque and shear-strain measurement. Sections have a common electrical connection. Exposed solder tab area is 0.13 x 0.08 in [3.3 x 2.0 mm].					
GAGE DIMENSIONS		Legend ES = Each Section CP = Complete Pattern S = Section (S1 = Section 1) M = Matrix			<input type="checkbox"/> inch <input type="checkbox"/> millimeter
Gage Length	Overall Length	Grid Width	Overall Width	Matrix Length	Matrix Width
0.187 ES	0.560 CP	0.150 ES	0.320 CP	0.63	0.39
4.75 ES	14.22 CP	3.81 ES	8.13 CP	15.9	9.8

GAGE SERIES DATA — See Gage Series datasheet for complete specifications			
Series	Description	Strain Range	Temperature Range
CEA	Universal general-purpose strain gages.	±5%	-100° to +350°F (-75° to +175°C)

Note 1: Insert desired S-T-C number in spaces marked XX.

Note 2: Products with designations and options shown in bold are not RoHS compliant.

General Purpose Strain Gages – Shear/ Torque Pattern

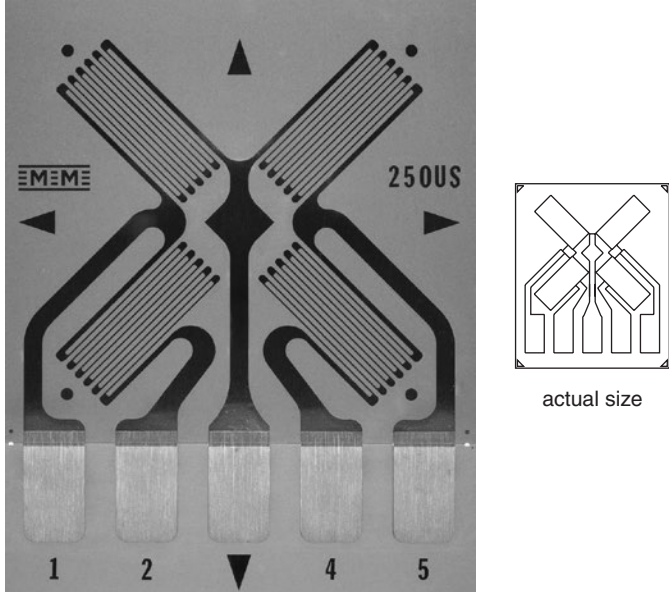
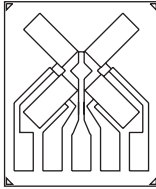
GAGE PATTERN DATA						
		<p>GAGE DESIGNATION See Note 1</p>		<p>RESISTANCE (OHMS)</p>	<p>OPTIONS AVAILABLE See Note 2</p>	
		<p>CEA-XX-250US-120 CEA-XX-250US-350</p>		<p>120 ± 0.4% 350 ± 0.4%</p>		
		 <p>actual size</p>				
<p>DESCRIPTION</p> <p>Four-element full-bridge pattern for shear-strain measurement. Grids are spaced 90° apart, and 45° from pattern centerlines. Exposed solder tab area is 0.16 x 0.10 in (4.1 x 2.5 mm).</p>						
<p>GAGE DIMENSIONS</p>			<p>Legend ES = Each Section CP = Complete Pattern S = Section (S1 = Section 1) M = Matrix</p>			
				inch	millimeter	
Gage Length	Overall Length	Grid Width	Overall Width	Matrix Length	Matrix Width	
0.250 ES	0.820 CP	0.120 ES	0.700 CP	0.96	0.80	
6.35 ES	20.83 CP	3.05 ES	17.78 CP	24.4	20.3	











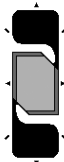

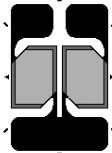
GAGE SERIES DATA — See Gage Series datasheet for complete specifications

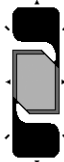
Series	Description	Strain Range	Temperature Range
CEA	Universal general-purpose strain gages.	±5%	-100° to +350°F (-75° to +175°C)

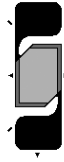
Note 1: Insert desired S-T-C number in spaces marked XX.

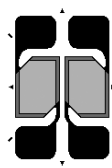
Note 2: Products with designations and options shown in bold are not RoHS compliant.

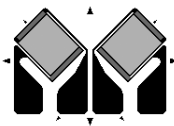
General Purpose Strain Gages

GAGE PATTERN	GAGE SERIES See Note 1	GAGE RESISTANCE (OHMS)	GAGE LENGTH	
			inches	millimeters
062DW   <p>actual size</p>	EA, ED, WA , WK, SA , SK , SD , WD	120, 350	0.062	1.57
	45° torque gage. Matrix size: 0.30L x 0.15W in. (7.6L x 3.8W mm)			
062TW   <p>actual size</p>	EA, WK, SA , SK	120, 350	0.062	1.52
	Two-element 90° torque gage. Matrix size: 0.27L x 0.21W in. (6.9L x 5.3W mm)			
090DW   <p>actual size</p>	EA, WA , WK, SA , SK	120, 350	0.09	2.29
	45° torque gage. Larger version of 062DW pattern. See also 090DY pattern. Matrix size: 0.38L x 0.19W in. (9.6L x 4.8W mm)			
090DY   <p>actual size</p>	EA, WA , WK, SA , SK	120, 350	0.09	2.29
	45° torque gage. Similar to the 090DW pattern except opposite grid angle. Matrix size: 0.38L x 0.19W in. (9.7L x 4.8W mm)			
125TH   <p>actual size</p>	EA, WA , WK, SA , SK	120, 350	0.125	3.18
	Two-element 90° torque gage. Sections are electrically independent. Matrix size: 0.44L x 0.31W in. (11.2L x 7.9W mm)			
125TR   <p>actual size</p>	EA, EK, S2K , WA , WK, SA , SK	120, 350, 1000	0.125	3.18
	Two-element 90° torque rosette. EK-Series gages are supplied with duplex copper dots (DD) when optional feature W or SE is not specified. Matrix size: 0.36L x 0.47W in. (9.1L x 11.9W mm)			

Note 1: Products with designations and options shown in **bold** are not RoHS compliant.

See <http://www.vishaypg.com/micro-measurements/stress-analysis-strain-gages/other-rosettes/> for complete specifications.

General Purpose Strain Gages

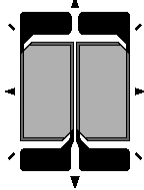
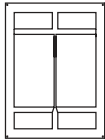
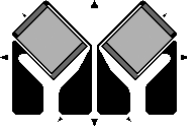
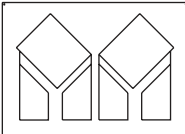
GAGE PATTERN	GAGE SERIES See Note 1	GAGE RESISTANCE (OHMS)	GAGE LENGTH	
			inches	millimeters
250TK   <p>actual size</p>	EA, WA , WK, SA , SK	120, 350, 1000	0.25	6.35
250TR   <p>actual size</p>	EA, EK, S2K , WA , WK, SA , SK	120, 350, 1000	0.25	6.35



Note 1: Products with designations and options shown in **bold** are not RoHS compliant.

See <http://www.vishaypg.com/micro-measurements/stress-analysis-strain-gages/other-rosettes/> for complete specifications.

SR-4[®] Strain Gages

SR-4® (Constantan Foil, Polyimide Carrier) Strain Gages

Following is a representative listing of the most popular gage patterns formerly manufactured by BLH. For availability of other SR-4 strain gages in other patterns and series—including those for transducer applications—please contact the Applications Engineering Department.

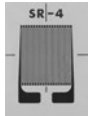
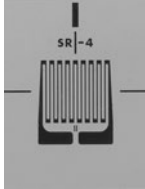
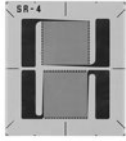
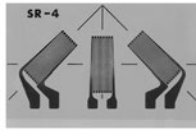
GAGE PATTERN		DESIGNATION	RES. IN OHMS	DIMENSIONS— inches (millimeters)				
				GRID LENGTH	OVERALL LENGTH	GRID WIDTH	MATRIX	
							Length	Width
	FAE-25-12SX	120 ±0.2	0.250 (6.35)	0.350 (8.89)	0.125 (3.18)	0.548 (13.92)	0.250 (6.35)	
	FAE-25-35SX	350 ±0.5	0.250 (6.35)	0.350 (8.89)	0.125 (3.18)	0.548 (13.92)	0.250 (6.35)	
	FAE-25-100SX	1000 ±0.2	0.235 (5.97)	0.425 (10.79)	0.175 (4.44)	0.710 (18.03)	0.465 (11.81)	
	FAE-12-12SX	120 ± 0.2	0.125 (3.18)	0.180 (4.57)	0.065 (1.65)	0.354 (8.99)	0.175 (4.45)	
	FAE-12-35SX	350 ± 0.5	0.125 (3.18)	0.180 (4.57)	0.062 (1.57)	0.359 (9.12)	0.180 (4.57)	
	FAE-12-100SX	1000 ± 0.2	0.125 (3.18)	0.180 (4.57)	0.062 (1.57)	0.364 (9.25)	0.185 (4.70)	
	Half-Square Grid—General Purpose							
	FAE-12S-12SX	120 ± 0.2	0.122 (3.10)	0.190 (4.38)	0.125 (3.18)	0.364 (9.25)	0.240 (6.10)	
	FAE-12S-35SX	350 ± 0.5	0.122 (3.10)	0.190 (4.38)	0.125 (3.18)	0.375 (9.53)	0.240 (6.10)	
	FAE-06S-12SX	120 ± 0.2	0.062 (1.57)	0.130 (3.30)	0.062 (1.57)	0.308 (7.82)	0.180 (4.57)	
	FAE-06S-35SX	350 ± 0.5	0.062 (1.57)	0.130 (3.30)	0.062 (1.57)	0.308 (7.82)	0.180 (4.57)	
	Square Grid—High Power Dissipation							
	FAE-03W-12SX	120 ± 0.2	0.031 (0.79)	0.075 (1.90)	0.062 (1.57)	0.269 (6.83)	0.140 (3.56)	
	FAE-03W-35SX	350 ± 0.5	0.031 (0.79)	0.075 (1.90)	0.062 (1.57)	0.269 (6.83)	0.152 (3.86)	
	Wide Grid—General Purpose, Low Profile							
	FAET-12A-12SX	120 ± 0.2	0.125 (3.18)	0.245 (6.22)	0.125 (3.18)	0.475 (12.07)	0.460 (11.68)	
	FAET-12A-35SX	350 ± 0.5	0.125 (3.18)	0.245 (6.22)	0.125 (3.18)	0.475 (12.07)	0.460 (11.68)	
	Tee-Rosette—General Purpose							
	FAER-25B-12SX	120 ± 0.2	0.250 (6.35)	0.380 (9.65)	0.125 (3.18)	0.604 (15.34)	0.935 (23.75)	
	FAER-25B-35SX	350 ± 0.5	0.250 (6.35)	0.385 (9.78)	0.125 (3.18)	0.600 (15.24)	0.935 (23.75)	
	FAER-12B-12SX	120 ± 0.2	0.125 (3.18)	0.190 (4.77)	0.062 (1.57)	0.350 (8.89)	0.485 (12.32)	
	FAER-12B-35SX	350 ± 0.5	0.125 (3.18)	0.190 (4.77)	0.062 (1.57)	0.355 (9.02)	0.500 (12.70)	
	3 Element Rosette—45° Planar							

Special Use Sensors

PATTERNS

Residual Stress Patterns	120
Magnetic Field Patterns	121
Standard Weldable Patterns	122
Sealed Weldable Patterns	124
High-Temperature Weldable Patterns	126
High-Temperature Patterns	128
Shear Modulus Testing Patterns	132
Concrete Embedment Gages.....	133

SENSORS

Temperature Sensors and LST Networks	134
Manganin Patterns	137
Crack Detection Patterns	139
Crack Propagation Patterns	141
Linear Displacement Sensor	143
Cable-Extension Displacement Sensor	145

Special Use Sensors—Residual Stress Strain Gages

The most widely used practical technique for determining residual stresses is the hole-drilling strain gage method described in ASTM Standard E837. With this method, a specially configured strain gage rosette is bonded to the surface of the test object; and a small, shallow hole is introduced into the structure, through the center of the gage, with a precision drilling apparatus. Strains in the immediate vicinity of the hole are measured, and the relaxed residual stresses are computed from these measurements. The general theory of making residual stress measurements is covered in Micro-Measurements Tech Note TN-503, "Measurement of Residual Stresses by the Hole-Drilling Strain Gage Method" and the requisite hardware is described in Datasheet 11304.

CONSTRUCTION

All gages are constructed of self-temperature-compensated foil (06 and 13 S-T-C) on a flexible polyimide carrier, and incorporate a centering target for use with a precision milling guide. EA-Series (A-Alloy) gages are available "open-faced" or with solder dots and encapsulation (Option SE); CEA-Series (A-Alloy) gages have encapsulated grids, and rugged, copper-coated solder tabs. Construction of the N2K Series (K-alloy) is similar to the N2A Series and includes copper pads (DP) on the solder tabs. The 062UM gage permits installation adjacent to weldments and intersecting surfaces.

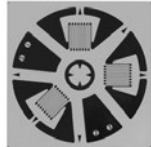
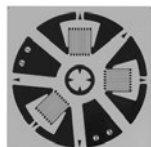
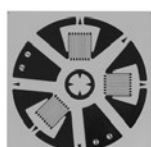
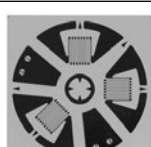
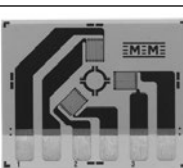
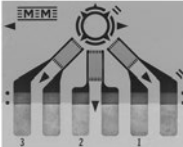
GAGE PATTERN AND DESIGNATION Insert Desired S-T-C No. in Spaces Marked XX. See Note 1.		RES. IN OHMS	DIMENSIONS					
			GAGE LENGTH	GRID CTR'LINE DIA.	TYPICAL HOLE DIA.		MATRIX	
					Min.	Max.	Length	Width
						inch	millimeter	
EA-XX-031RE-120 EA-XX-031RE-120/SE		120 ± 0.2% 120 ± 0.4%	0.031	0.101	0.03	0.04	0.29	0.29
			0.79	2.56	0.8	1.0	7.4	7.04
			Due to small pattern size, measurement error can be magnified by slight mislocation of drill hole. Pattern not recommended for general-purpose applications.					
N2K-XX-030RR-350/DP		350 ± 0.4%	0.30	0.170	0.090	0.100	0.37	0.37
			0.76	4.32	2.3	2.5	9.4	9.4
			Special six-element configuration that provides somewhat higher output than three-element designs.					
EA-XX-062RE-120 EA-XX-062RE-120/SE		120 ± 0.2% 120 ± 0.4%	0.062	0.202	0.06	0.08	0.42	0.42
			1.57	5.13	1.5	2.0	10.7	10.7
			Most widely used RE pattern for general-purpose residual stress measurement applications.					
EA-XX-125RE-120 EA-XX-125RE-120/SE		120 ± 0.2% 120 ± 0.4%	0.125	0.404	0.12	0.16	0.78	0.78
			3.18	10.26	3.0	4.1	19.8	19.8
			Larger version of the 062RE pattern.					
CEA-XX-062UL-120		120 ± 0.4%	0.062	0.202	0.06	0.08	0.50	0.62
			1.57	5.13	1.5	2.0	12.7	15.7
			Fully encapsulated with large copper-coated soldering tabs. Same pattern geometry as 062RE pattern.					
CEA-XX-062UM-120		120 ± 0.4%	0.062	0.202	0.06	0.08	0.38	0.48
			1.57	5.13	1.5	2.0	9.6	12.2
			Fully encapsulated with large copper-coated soldering tabs and special trim alignment marks. Trim line spaced 0.068 in (1.73 mm) from hole center. Limitations may exist in data reduction equations.					

Note 1: Products with designations and options shown in bold are not RoHS compliant.

Special Use Sensors – Magnetic Field Strain Gages

Intense, time-varying electromagnetic fields with steep gradients in field strength can cause troublesome noise in strain gage circuits. In severe magnetic environments, with low signal levels, the noise amplitude may be several times larger than the strain signal from the gage. Micro-Measurements H-Series noninductive strain gages have been specially designed to minimize noise pickup in the gage grid due to electromagnetic fields.

H-Series strain gages consist of two identical grids, with one stacked directly above and insulated from, the other. The upper and lower grid elements are connected in series so that current flows in opposite directions through the two grids. With this arrangement, noise voltages induced in the grid tend to be self-cancelling. The counter-current principle employed in H-Series gages is particularly effective against magnetic field gradients parallel to the test surface.

H-Series strain gages have been used very successfully in fusion research applications and similar environments with flux densities to 50 000 gauss.

CONSTRUCTION

H-Series strain gages are constructed with two 350-ohm constantan alloy foil grids on a glass-fiber-reinforced

epoxy phenolic carrier. These fully encapsulated gages include closely spaced, heavy copper terminals for direct leadwire attachment. H-Series gages are available in both a single axis and a delta (60°) rosette pattern. The available S-T-C number is 06.

ADHESIVES

Micro-Measurements M-Bond 600 or AE-15 adhesive systems are particularly recommended; M-Bond 600 produces the thinnest glue line. Adhesive cure temperature should not exceed the maximum sensor operating temperature of +250°F (+120°C).

LEADWIRES

In many cases, the leadwire system itself is the principal source of magnetic noise induction in the measuring circuit. Careful attention to details as outlined in Micro-Measurements Tech Note TN-501, "Noise Control in Strain Gage Measurements", is strongly recommended.

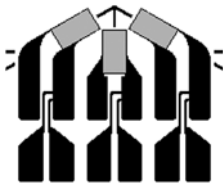
GAGE PATTERN AND DESIGNATION		RES. IN OHMS	DIMENSIONS					
			Legend: ES = Each Section					
			GAGE LENGTH	OVERALL LENGTH	GRID WIDTH	OVERALL WIDTH	MATRIX	
Length	Width							
H06A-AC1-125-700		700 ± 0.5%	inch					
			millimeter					
			0.125	0.49	0.125	0.125	0.61	0.22
			3.18	12.4	3.18	3.18	15.5	5.6
Single-axis pattern with integral copper terminals.								
H06A-AD3-125-700		700 ± 0.5%	0.125 ES	0.56	0.080 ES	0.620	0.65	0.70
			3.18 ES	14.2	2.03 ES	15.75	16.5	17.8
			Three-element 60° delta rosette with integral copper terminals.					

Where magnetic noise is likely to be encountered, the selection of the strain gage grid alloy should be given careful consideration. If the grid alloy is magnetic, it will be subject to extraneous physical forces in a magnetic field; and, if magnetoresistive, will undergo spurious resistance changes. Similarly, if the alloy is magnetostrictive, the grid will tend to change length in the magnetic field. While constantan is comparatively free from magnetic effects over its normal operating temperature range, specific measurement applications may indicate desirability of a different sensing grid alloy. Contact our Applications Engineering Department for details.

Special Use Sensors—Weldable Strain Gages

Micro-Measurements Standard Weldable Strain Gages and Temperature Sensors are specially designed for spot welding to structures and components. They are ideal for applications where test or environmental conditions preclude clamping and curing an adhesively bonded gage installation. These gages are equally advantageous when strain measurements must be made at an elevated temperature, but the nature of the test object does not permit the use of an elevated-temperature-curing adhesive.

Surface preparation requirements are minimal; only an appropriate solvent cleaning and abrasion of the test part surface with silicon-carbide paper or a small, hand-held grinder is needed. Spot welding is accomplished with a portable stored-energy hand-probe spot welder, such as the Model 700. Environmental protection is as easily applied to a welded gage installation as to an adhesively bonded gage.

Refer to Instruction Bulletin B-131 and MM Strain Gage Accessories Data Book for further information on installation and protective coatings. For specifications about the Model 700 Welding/Soldering Unit, please refer to the product datasheet.

DESCRIPTION AND PERFORMANCE

General—All sensors are laboratory-prebonded, with a high-performance adhesive, to thin [0.005 in (0.13 mm)] metal carriers. Sensor grids are fully encapsulated for protection against handling and installation damage. Standard weldable strain gages are offered in two series to meet differing performance requirements. Both series are available in either 06 or 09 self-temperature compensation. Strain gages with 06 S-T-C have Inconel carriers, while S-T-C 09 gages and temperature sensors are mounted on 300-series stainless steel.

CEA-Series Weldable Strain Gage—Polyimide-encapsulated constantan foil grid, with large, rugged,

copper-coated tabs. In most cases, the carrier can be contoured to a radius as small as 1/2 in (13 mm). The CEA Series is ideal for direct leadwire attachment, before or after installation.

Strain range is $\pm 5000 \mu\text{in/in}$ ($\pm 5000 \mu\text{m/m}$), and normal operating temperature range is -100° to $+200^\circ\text{F}$ (-75° to $+95^\circ\text{C}$). Short-term maximum temperature is $+300^\circ\text{F}$ ($+150^\circ\text{C}$).

LWK-Series Weldable Strain Gage—Nickel-chromium alloy grid, encapsulated in fiberglass-reinforced epoxy phenolic. The LWK gage is provided with a three-wire lead system with 10 in (250 mm) of Teflon[®]-insulated leadwire.

This construction simplifies leadwire temperature compensation and provides for easy connection of the lead system to the instrumentation cable. Minimum installation radius is generally limited to 2 in (50 mm).

Strain range is $\pm 5000 \mu\text{in/in}$ ($\pm 5000 \mu\text{m/m}$), and normal operating temperature range is -320° to $+500^\circ\text{F}$ (-195° to $+260^\circ\text{C}$). Short-term maximum temperature is $+550^\circ\text{F}$ ($+290^\circ\text{C}$).

WWT-Series Temperature Sensor—High-purity nickel foil grid encapsulated in fiberglass-reinforced epoxy-phenolic, and equipped with integral three-tab terminal to facilitate leadwire attachment. The temperature sensor is normally installed on a flat surface of the workpiece, but, in any case, should always be oriented with the gridlines in the direction of minimum strain to avoid strain-induced errors (see Micro-Measurements Tech Note TN-506, “Bondable Resistance Temperature Sensors and Associated Circuitry”). With an appropriate LST Matching Network, the temperature response characteristic of the nickel can be linearized and scaled for direct readout (in degrees) with any strain indicator.



Teflon is a Registered Trademark of DuPont.

MEASUREMENT CONSIDERATIONS

It is important to note that operating characteristics of weldable strain gages (gage factor, transverse sensitivity, and thermal output) are specified for the basic strain gage itself—without the metal carrier. Thus, the properties are measured by bonding a conventional strain gage directly to an appropriate calibration specimen, following standard methods specified for all Micro-Measurements strain gages. This procedure assures the most accurate results, independent of the variables introduced by welding. In particular, the user should be aware that the gage factor specified on the engineering data sheet accompanying the gage applies only to the basic strain gage, without the shim. The effective gage factor of the weldable assembly

(after welding to the test member) is commonly 5 to 10% lower than this, due primarily to the stiffness of the shim. The reduction in gage factor is not subject to quantitative generalization, because it depends on the cross-sectional properties of the test specimen, and on the mode of loading (e.g., bending versus direct stress). It has been demonstrated, however, that for a group of like specimens, loaded in the same manner, the weldable gages exhibit very good repeatability and uniformity of response. Therefore, when test requirements dictate greatest accuracy, the weldable gages should be calibrated on a specimen of the same material and cross section as the test part, and under the same mode of loading.

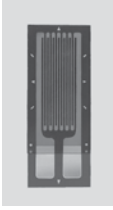
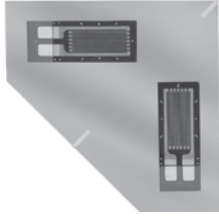
Special Use Sensors—Weldable Strain Gages

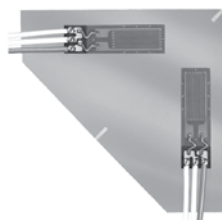
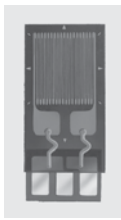
GAGE PATTERN AND DESIGNATION Insert Desired S-T-C No. in Spaces Marked XX. See Note 1		RES. IN OHMS	DIMENSIONS						
			Legend: ES = Each Section						
			CARRIER			ACTIVE GRID		MATRIX	
Length	Width	Thick	Length	Width	Length	Width			
CEA-XX-W250A-120 CEA-XX-W250A-350		120 ± 0.4% 350 ± 0.4%	0.63	0.34	0.005	0.230	0.125	0.44	0.17
			16.0	8.6	0.13	5.84	3.18	11.2	4.3
			Most flexible and conformable pattern. Type 326-DFV and 330-DFV flat three-conductor cable typically used to solder directly to copper-coated tabs.						
CEA-XX-W250C-120 CEA-XX-W250C-350		120 ± 0.4% 350 ± 0.4%	0.90	0.90	0.005	0.230	0.125	0.44	0.17
			22.9	22.9	0.13	5.84	3.18	11.2	4.3
			Tee rosette, used in biaxial stress states where directions of principal stresses are known. See W250A pattern for typical leadwire recommendations.						
LWK-XX-W250B-350		350 ± 0.4%	0.88	0.32	0.005	0.250	0.125	0.62	0.17
			22.4	8.1	0.13	6.35	3.18	15.7	4.3
			Wide-temperature-range linear pattern with 10 in (250 mm) preattached leads. Teflon insulation is pretreated for best bond to protective coatings.						
LWK-XX-W250D-350		350 ± 0.4%	1.15	1.15	0.005	0.250	0.125	0.62	0.17
			29.2	29.2	0.13	6.35	3.18	15.7	4.3
			Tee rosette, used in biaxial stress states where directions of principal stresses are known and a wide operating temperature range is required.						
WWT-TG-W200B-050		50 ± 0.4% @ +75°F (+24°C)	0.71	0.43	0.005	0.200	0.200	0.52	0.26
			18.0	10.9	0.13	5.08	5.08	13.1	6.6
			Easy-to-use temperature sensor that can be welded or adhesively bonded to the test structure. For standard bondable temperature sensors, see Document Number 11522, "Temperature Sensors and LST Networks."						

Note 1: Products with designations and options shown in bold are not RoHS compliant.

Special Use Sensors – Weldable Strain Gages

Micro-Measurements Sealed Weldable Strain Gages are specially designed for spot welding to structures and components. They are ideally used for applications where test or environmental conditions preclude clamping and curing an adhesively bonded gage installation. These gages are equally advantageous when strain measurements must be made at elevated temperatures, but the nature of the test object does not permit the use of an elevated temperature-curing adhesive. Additionally, all Micro-Measurements Sealed Weldable Strain Gages come with a preinstalled protective coating providing both protection in moist environments and savings in the time and effort required for making the complete gage installation.

All sensors are fabricated with EA-Series strain gages, laboratory-prebonded with a high-performance adhesive to a thin [0.005 in (0.127 mm)] stainless steel carrier, and fully encapsulated for protection against moisture. They have a ± 5000 microinch/in strain range, and a normal operating temperature range of -40°F (-40°C) to $+180^{\circ}\text{F}$ ($+83^{\circ}\text{C}$). These gages can be used on surfaces with a radius of curvature of 3.0 in (76 mm) or greater.

The three leadwire-series of Micro-Measurements Sealed Weldable Strain Gages have physical constructions designed for various environmental exposures and installation constraints.



R-LEADWIRE-SERIES

These gages are designed for long-term out-of-doors use. Primarily used in applications such as railroad and civil structures, they can be exposed to oil and water splash and short-term submersion in water of shallow [24 in (60 cm)] depth. The metal carrier is processed to give good first cycle data, excellent fatigue resistance and a high strain range.

Exposure of the vinyl-insulated cable to strong solvents—especially MEK—should be avoided to prevent damage. Long-term exposure to sub-freezing temperatures requires careful handling to avoid cracking of the vinyl insulation.

DESIGNATION	NOMINAL RESISTANCE (Ohms)	NOMINAL GAGE FACTOR	GRID GEOMETRY	GAGE LENGTH (in)	LEADWIRE	SHIM LENGTH (in)	SHIM WIDTH (in)
LEA-06-W125E-350/3R	350	2.0	Axial	0.125	Vinyl	0.8	0.4
	<p>Bridge Circuit</p>		<p>Configuration</p>				
LEA-06-W125F-350/3R	350	2.0	Shear	0.125	Vinyl	1.0	0.5
	<p>Bridge Circuit</p>		<p>Configuration</p>				

Special Use Sensors—Weldable Strain Gages

T-LEADWIRE-SERIES

This series is designed to withstand exposure to water pressures of up to 500 psi. They can also withstand short-term (up to 14 days) immersion in crude oil. A flexible stainless steel tube, providing wire routing from the strain gage to a cable transition, enables fine positioning of the sensor as well as providing strain relief. These sensors are typically used on larger civil structures, including bridges, dams, and buildings, or for exposures of up to a year in seawater.

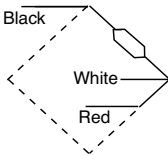
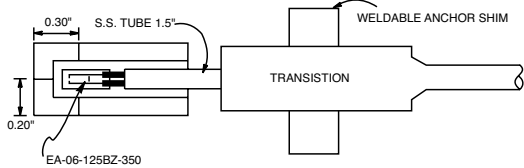
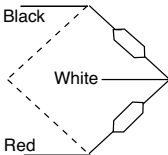
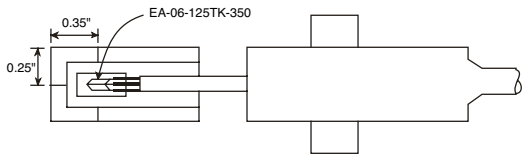
DESIGNATION	NOMINAL RESISTANCE (Ohms)	NOMINAL GAGE FACTOR	GRID GEOMETRY	GAGE LENGTH (in)	LEADWIRE	SHIM LENGTH (in)	SHIM WIDTH (in)
LEA-06-W125E-350/10T	350	2.0	Axial	0.125	Shielded Vinyl	0.8	0.4
	 <p>Bridge Circuit</p>		 <p>Configuration</p>				
LEA-06-W125F-350/10T	350	2.0	Shear	0.125	Shielded Vinyl	1.0	0.5
	 <p>Bridge Circuit</p>		 <p>Configuration</p>				

L-LEADWIRE-SERIES

The L-Leadwire-Series sensors are designed to have a performance similar to the T-Leadwire-Series but without a cable transition. They can be used in similar applications when the sensor will be exposed to smaller strains, and care can be taken during installation to anchor the leadwire to provide for strain relief. The L-Leadwire-Series gages are particularly useful where space constraints preclude the use of the cable transition of T-Leadwire-Series gages.

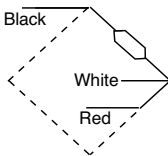
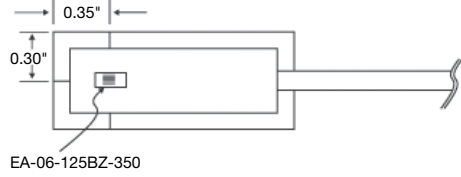
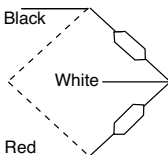
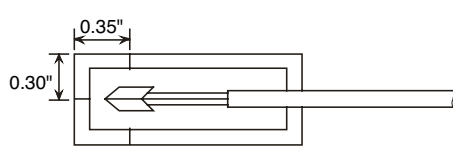
DESIGNATION	NOMINAL RESISTANCE (Ohms)	NOMINAL GAGE FACTOR	GRID GEOMETRY	GAGE LENGTH (in)	LEADWIRE	SHIM LENGTH (in)	SHIM WIDTH (in)
LEA-06-W125E-350/10L	350	2.0	Axial	0.125	Shielded Vinyl	1.5	0.6
	 <p>Bridge Circuit</p>		 <p>Configuration</p>				
LEA-06-W125F-350/10L	350	2.0	Shear	0.125	Shielded Vinyl	1.5	0.6
	 <p>Bridge Circuit</p>		 <p>Configuration</p>				

Special Use Sensors – Weldable Strain Gages

FEATURES

- High temperature installations using simple attachment techniques
- Ceramic bonded wire gage performance in a weldable gage
- Superior performance of bonded gages
- Improved fatigue life for dynamic applications

Micro-Measurements high-temperature weldable strain gages are free-filament wire strain gages pre-bonded to shim stock using flame sprayed alumina. The gages can be welded to the test structure using a capacitive discharge spot welder (such as Micro-Measurements Model 700), permitting easy installation in the field, especially on large structures. High-temperature weldable strain gages are excellent in applications where protection against moisture is not required. The fatigue resistance of this bonded wire strain gage makes it the best choice for dynamic, impact or vibratory strain measurements to 1800°F (980°C). Their use in measuring static strains should be avoided.

High-temperature weldable strain gages are available with grids of Nichrome V (N) or Pt8W (E) alloys. They can be ordered with either of two types of preattached high-temperature insulated cable.



RoHS
COMPLIANT

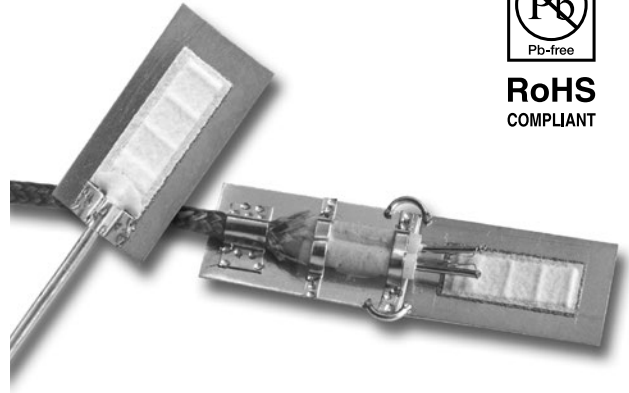

GAGES WITH M-SERIES LEADWIRES

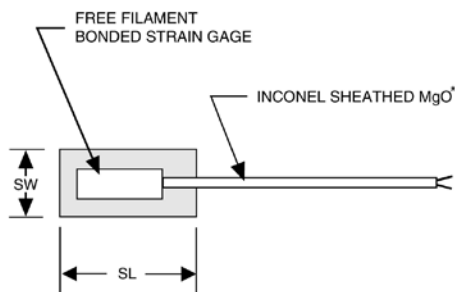

Complete assembly consists of a free-filament gage bonded to a shim with an integral high-temperature cable with chromel/alumel wires. The mineral insulated, two-conductor cable with an Inconel metal jacket is rated to 1800°F (980°C) and offers excellent protection in harsh environments. While the ends are sealed to avoid moisture absorption during shipping or storage, care should be taken when using M-Series cables to ensure that the mineral insulation does not absorb moisture during handling and application.

GAGES WITH F-SERIES LEADWIRES

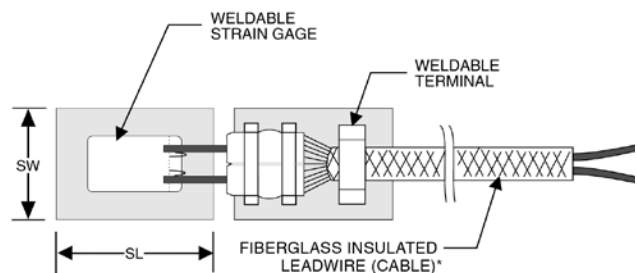

Complete assembly consists of a free-filament gage bonded to a shim, a weldable transition terminal and a high temperature cable with chromel/alumel wire. A fiberglass-insulated braided, two-conductor cable assembly is attached at the gage end through alumina insulators strap-welded to the terminal shim, providing a firm anchor for the cable at the gage end. The cable conductors are threaded through lengthwise holes in the alumina insulators and bonded to the insulators with high strength ceramic cement to prevent wire movement at the gage—cable weld junction. The fiberglass cable is rated to 1200°F (650°C) and is used where fraying due to vibration is not a concern. F-Series cables are more flexible than M-Series cables.

Special Use Sensors—Weldable Strain Gages

DESIGNATION	NOMINAL RESISTANCE	NOMINAL GAGE FACTOR	SENSOR ALLOY	SENSOR GAGE LENGTH	MAX. TEMP.	LEADWIRE	SHIM LENGTH (SL)	SHIM WIDTH (SW)	LEAD TERMINAL
LZN-NC-W250G-120/2F	120 Ω	2.0	NiChrome V	0.25 in (6.35 mm)	1200°F (649°C)	Chromel-Alumel	0.50 in (12.7 mm)	0.30 in (7.62 mm)	Yes
LZN-NC-W250G-120/2M					1600°F (871°C)				None
LZE-NC-W250G-120/2F	120 Ω	4.0	Pt8W	0.25 in (6.35 mm)	1200°F (649°C)	Chromel-Alumel	0.50 in (12.7 mm)	0.30 in (7.62 mm)	Yes
LZE-NC-W250G-120/2M					1600°F (871°C)				None

NOTE

The standard leadwire length is indicated, in feet, by the number to the left of the last letter of the gage designation. For example, /2F indicates 2 feet of fiberglass insulated leadwire. Gages with longer leadwires (up to 50 feet) are available on special order.

Special Use Sensors—High-Temperature Strain Gages

FEATURES

- Measurement range to 2100°F (1150°C)
- Free-filament Kanthal alloy grids for bonding with ceramic adhesives
- Linear and Tee-rosette patterns

ZC-Series strain gages are etched Kanthal (Fe-Cr-Al alloy) foil grids in free-filament form for high-temperature applications. They are bonded with either ceramic adhesives, or by the use of flame spray.

ZC-Series strain gages cannot be self-temperature compensated, and a dummy compensating gage must be used for minimizing of thermally induced apparent strain (thermal output). Several patterns are available with built-in compensating grids.

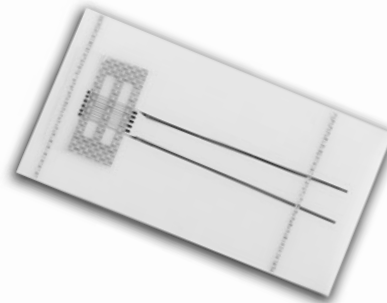

RoHS
COMPLIANT



ZC-Series strain gages are supplied with a removable high-temperature carrier for gage handling during installation. All patterns have 1 in (25.4 mm) Nichrome ribbon leads spot welded to the gage tabs for leadwire attachment.

GAGE PATTERN				inch millimeter	GAGE DESIGNATION	RES. IN OHMS
Not actual size shown. Enlarged when necessary for definition.						
DIMENSIONS						

G1262				Square linear pattern.								
				ZC-NC-G1262-120			120					
GAGE LENGTH	OVERALL LENGTH	GRID WIDTH	OVERALL WIDTH									
0.062	0.150	0.076	0.076									
1.57	3.81	1.93	1.93									
MATRIX SIZE	N/A											

G1263				Wide linear pattern.								
				ZC-NC-G1263-120			120					
GAGE LENGTH	OVERALL LENGTH	GRID WIDTH	OVERALL WIDTH									
0.100	0.248	0.179	0.179									
2.54	6.30	4.55	4.55									
MATRIX SIZE	N/A											

Special Use Sensors—High-Temperature Strain Gages

GAGE PATTERN Not actual size shown. Enlarged when necessary for definition.				GAGE DESIGNATION	RES. IN OHMS
DIMENSIONS			<input type="checkbox"/> inch <input type="checkbox"/> millimeter		
G1264 				Linear pattern with inactive temperature-compensating grid.	
GAGE LENGTH	OVERALL LENGTH	GRID WIDTH	OVERALL WIDTH	ZC-NC-G1264-120	120
0.100	0.310	0.179	0.430		
2.54	7.87	4.55	10.92		
MATRIX SIZE	N/A				
G1265 				Linear pattern.	
GAGE LENGTH	OVERALL LENGTH	GRID WIDTH	OVERALL WIDTH	ZC-NC-G1265-120	120
0.138	0.300	0.138	0.138		
3.51	7.62	3.51	3.51		
MATRIX SIZE	N/A				
G1266 G1272 				Linear pattern. Higher resistance linear pattern.	
GAGE LENGTH	OVERALL LENGTH	GRID WIDTH	OVERALL WIDTH	ZC-NC-G1266-120 ZC-NC-G1272-350	120 350
0.200	0.380	0.135	0.135		
5.08	9.65	3.43	3.43		
MATRIX SIZE	N/A				

Special Use Sensors—High-Temperature Strain Gages

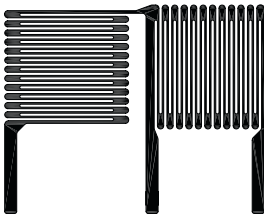
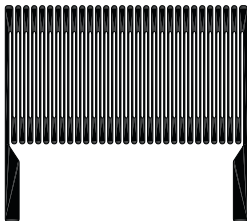
GAGE PATTERN Not actual size shown. Enlarged when necessary for definition.				GAGE DESIGNATION	RES. IN OHMS
DIMENSIONS			inch millimeter		
G1267 				Linear pattern with inactive temperature-compensating grid.	
				ZC-NC-G1267-120	120
GAGE LENGTH	OVERALL LENGTH	GRID WIDTH	OVERALL WIDTH		
0.200	0.503	0.134	0.442		
5.08	12.78	3.40	11.23		
MATRIX SIZE	N/A				
G1269 G1275 				Tee-rosette pattern in half-bridge configuration.	
				ZC-NC-G1269-200 ZC-NC-G1275-350	120 350
GAGE LENGTH	OVERALL LENGTH	GRID WIDTH	OVERALL WIDTH		
0.125	0.278	0.150	0.346		
3.18	7.06	3.81	8.79		
MATRIX SIZE	N/A				
G1270 				Higher resistance linear pattern.	
				ZC-NC-G1270-350	350
GAGE LENGTH	OVERALL LENGTH	GRID WIDTH	OVERALL WIDTH		
0.100	0.250	0.280	0.300		
2.54	6.35	7.11	7.62		
MATRIX SIZE	N/A				

Special Use Sensors—High-Temperature Strain Gages

GAGE FACTOR VARIATION WITH TEMPERATURE FOR ZC-SERIES GAGE

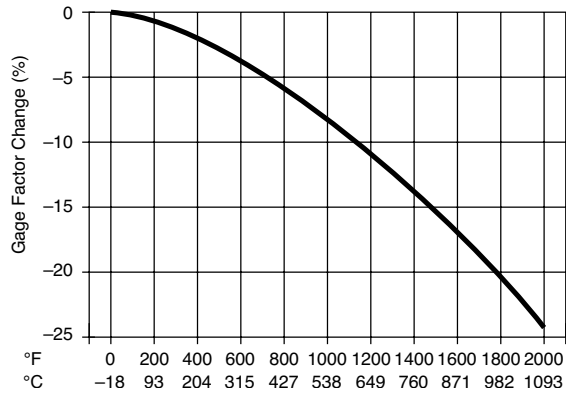

TYPICAL APPARENT STRAIN ZC-SERIES GAGE ON TITANIUM WITH H CEMENT

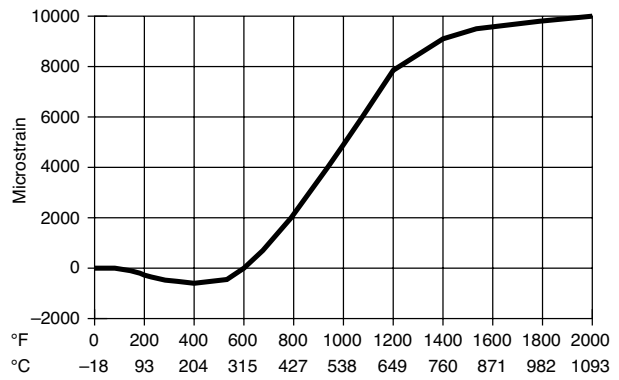

APPARENT STRAIN/THERMAL OUTPUT FOR LINEAR GRID WITH TEMPERATURE COMPENSATING DUMMY GRID ON TITANIUM (GAGE TYPE: ZC-NC-G1267-120)

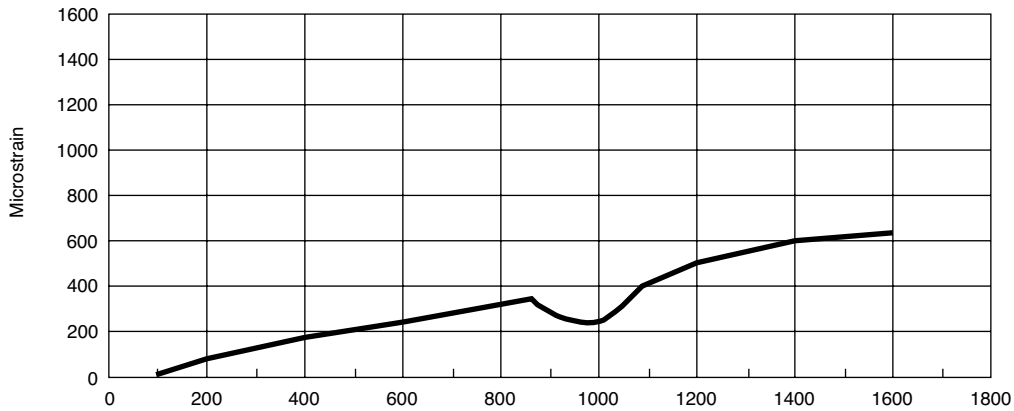

Special Use Sensors – Shear Modulus Testing Strain Gages

Shear Modulus Sensors are specifically designed to accommodate the unique specimen geometries and strain-field distributions encountered when testing composite materials for shear properties. Two popular specimens for in-plane shear modulus testing of composites are the losipescu and compact designs. The test section for both types is described as the area between two opposing notches. The losipescu specimen has a distance between the notch roots of 0.45 in (11.4 mm); for the compact design this distance is 0.75 in (19 mm). Both of these specimens have an inherently nonuniform shear-strain distribution in their test zone. Determining shear modulus requires extracting an average shear-strain value from this nonuniform strain field. Since strain gages have the unique characteristic of integrating the surface strain field under their grids, average specimen strain is automatically obtained by spanning the entire length of either specimen's test section.

Two 500 Ω ±0.4%, ±45° shear-gage configurations are available for both the losipescu and compact specimen designs. The planar configuration, with side-by-side

grids, is constructed with a standard N2 backing and Option SP61 (soft, copper lead ribbons and polyimide film encapsulation). The stacked configuration is produced with a special backing, A2. This backing is similar to N2 but is fully encapsulated with a polyimide film and includes integral soft, copper lead ribbons (like those provided by Option SP61). The stacked configuration is offered to best simulate strain measurement at a point. The stacked gages are supplied in a quarter-bridge arrangement so that independent gage measurements can be made if necessary. When connected in a half-bridge circuit, the stacked construction inherently provides temperature compensation and insensitivity to normal strains. Due to the increased stiffness of a stacked sensor, compared to one having only a single layer, an evaluation of the test conditions and requirements should be made to ensure that the gage will not compromise accuracy by significantly reinforcing low-modulus and/or thin specimens.

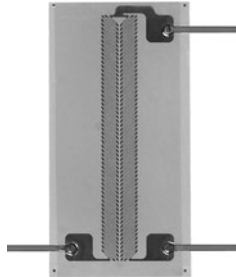
GAGE PATTERN AND DESIGNATION Insert Desired S-T-C No. in Spaces Marked XX.		 RoHS COMPLIANT	DIMENSIONS Legend: ES = Each Section				<table border="1"> <tr><td>inch</td></tr> <tr><td>millimeter</td></tr> </table>		inch	millimeter
			inch							
millimeter										
	N2A-XX-C032A-500/SP61 N2P-08-C032A-500/SP61 N2A-XX-C032B-500/SP61 N2P-08-C032B-500/SP61	0.032 ES 0.462 0.031 ES 0.197 0.81 ES 11.73 0.79 ES 5.00	0.031 ES 0.197 0.800 0.257 0.81 ES 19.35 0.79 ES 5.00	MATRIX						
				Length	Width					
For use with losipescu specimens.										
For use with compact specimens.										
For use with losipescu specimens.										
For use with compact specimens.										

Special Use Sensors—Concrete Embedment Strain Gages

The EGP-Series Embedment Strain Gage is specially designed for measuring mechanical strains inside concrete structures. The sensing grid, constructed of a nickel-chromium alloy (similar to Karma), has an active gage length of 4 in (100 mm) for averaging strains in aggregate materials. A rugged 5 in (130 mm) outer body of proprietary polymer concrete resists mechanical damage during pouring, minimizes reinforcement of the structure, and provides protection from moisture and corrosive attack. The grid, cast within the polymer concrete to ensure maximum strain sensitivity, is self-temperature-compensated to minimize thermal output when installed in concrete structures. Each gage incorporates a heavy-duty 10 ft (3 m) cable with 22-AWG (0.643 mm dia.) leadwires; a three-wire construction to the sensing grid helps minimize temperature effects in the instrumentation leads. Special lengths of preattached cable will be quoted upon request. Micro-Measurements M-LINE accessory cable 322-DJV is available for adding cable length in the field.



Rugged and reliable, EGP-Series Strain Gages are available in both 120-ohm (EGP-5-120) and 350-ohm (EGP-5-350) resistances.

SPECIFICATIONS

- **Construction:** Strain sensing grid cast in a sturdy, water-resistant material.
- **Sensing Grid:** Nickel-chromium alloy on polyimide backing. Active gage length of 4 in (100 mm) nominal. Grid resistance of 120 or 350 ohms, $\pm 0.8\%$.
- **Outer Body:** Proprietary polymer concrete. 5 x 0.7 x 0.4 in (130 x 17 x 10 mm) nominal.
- **Cable:** Three 10 ft (3 m) leads of 22-AWG (0.643 mm dia.) stranded tinned copper in 0.015 in (0.4 mm) thick PVC insulation. Nominal cable diameter of 0.2 in (5 mm). (Other lengths quoted upon request.)
- **Temperature Range:** The normal usage range is $+25^\circ$ to $+125^\circ\text{F}$ (-5° to $+50^\circ\text{C}$). Extended range is -25° to $+150^\circ\text{F}$ (-30° to $+60^\circ\text{C}$).

GAGE DESIGNATION		RES. IN OHMS	DIMENSIONS			
			ACTIVE GAGE LENGTH	OUTER BODY WIDTH	OUTER BODY LENGTH	OUTER BODY THICKNESS
EGP-5-120		120 \pm 0.8%	4	0.7	5	0.4
			100	17	130	10
EGP-5-350		350 \pm 0.8%	4	0.7	5	0.4
			100	17	130	10

Special Use Sensors – Temperature

Resistance thermometry is a widely employed method of measuring temperature, and is based on using a material whose resistivity changes as a function of temperature. Resistance Temperature Detectors (RTD's) have fast response time, provide absolute temperature measurement (since no reference junctions are involved), and are very accurate. Their measurement circuits are relatively simple, and the sensors, when properly installed, are very stable over years of use.

Micro-Measurements resistance temperature sensors are constructed much like wide-temperature-range strain gages. The standard sensors utilize nickel or nickel/manganin grids, although special-purpose gages are also available in Balco® alloy or copper foil grids. These temperature sensors are bonded to structures using standard strain gage installation techniques, and can measure surface temperatures from -452° to approximately +500°F (-269° to +260°C). Because of their extremely low thermal mass and the large bonded area, the sensors follow temperature changes in the structural mounting surface with negligible time lag.

Balco is a trademark of the W.B. Driver Company

TG TEMPERATURE SENSORS

TG Temperature Sensors are normally selected for measurements from -320° to +500°F (-195° to +260°C). The sensing grid utilizes a high purity nickel. Three basic constructions are offered:







ETG Sensors have a polyimide carrier for flexibility. It is available as an encapsulated gage with exposed solder tabs (Option E), or with integral printed-circuit terminals (Option W).

The WTG Sensor incorporates integral leadwires and a high-temperature epoxy-phenolic matrix (reinforced with glass fiber) which fully encapsulates the grid.

The WWT-TG Sensor is a slightly larger version of the WTG, but preattached to a 0.005-in (0.13-mm) thick stainless steel shim. This gage can be welded or bonded to a structure.

The resistance at +75°F (+23.9°C) is 50Ω ±0.3% for the ETG and WTG Sensors; and 50Ω ±0.4% for the WWT-TG Sensors.

Maximum operating temperature for ETG Sensors with Option E is +450°F (+230°C), and +350°F (+175°C) for Option W. All other types are +500°F (+260°C).

TG TEMPERATURE SENSORS GAGE PATTERN AND DESIGNATION		DIMENSIONS					
		GAGE LENGTH	OVERALL LENGTH	GRID WIDTH	OVERALL WIDTH	MATRIX Length Width	
ETG-50A/Option E ETG-50A/Option W   		0.060	0.148	0.100	0.100	0.28	0.20
		1.52	3.76	2.54	2.54	7.0	4.8
ETG-50B/Option E ETG-50B/Option W 50A/E 50B/E Opt W Feature		0.125	0.235	0.125	0.125	0.33	0.19
		3.18	5.97	3.18	3.18	8.3	4.7
WTG-50A WTG-50A/Option W   		0.060	0.148	0.100	0.100	0.28	0.20
		1.52	3.76	2.54	2.54	7.0	4.8
WTG-50B WTG-50B/Option W 50A 50B Opt W Feature		0.125	0.235	0.125	0.125	0.33	0.19
		3.18	5.97	3.18	3.18	8.3	4.7
WWT-TG-W200B-050 For Weldable Temperature Sensor, see appropriate datasheet. 		0.20	0.71 SL	0.200	0.43 SW	0.52	0.26
		5.08	18.03 SL	5.08	10.92 SW	13.1	6.6

Note 1: Products with designations and options shown in bold are not RoHS compliant.

In addition to the standard line of temperature sensors described above, Micro-Measurements can furnish almost any type of sensor pattern desired, in a wide range of resistances. Contact our Applications Engineering Department for details.

Special Use Sensors—Temperature

TYPICAL DATA FOR 50 Ω NICKEL SENSOR

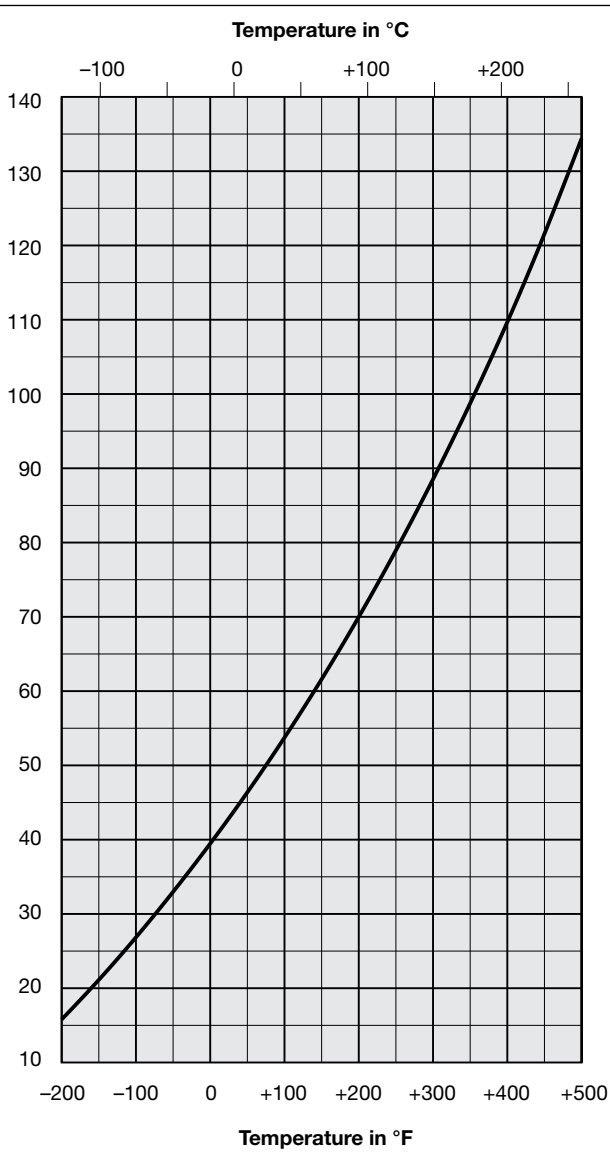

TG LST MATCHING NETWORKS

The temperature coefficient of resistance of nickel sensors is very high but nonlinear as indicated in the graph. The sensor resistance can be measured directly and converted to temperature with the charts supplied in Tech Note TN-506, but since TG Sensors are commonly used along with strain gages, special matching networks have been developed to use with strain gage instrumentation.

These LST Matching Networks are small passive devices encapsulated in a molded epoxy case. They are connected between TG Temperature Sensors and the strain gage readout instrumentation to perform the following three functions:

1. Linearize the gage resistance versus temperature.
2. Attenuate the resistance change slope to the equivalent of 10 or 100 microstrain per degree F or C for a gage factor setting of 2.000 on the strain indicator.
3. Present a balanced 350-ohm half-bridge circuit to the strain indicator at the reference temperature of 0°F (Fahrenheit networks) or 0°C (Celsius networks).

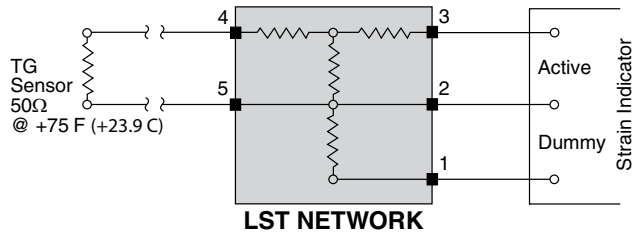

In order to optimize performance, separate network designs are available for cryogenic and normal temperature ranges. Environmental temperature range of LST networks is -65° to +250°F (-55° to +125°C). Standard strain gage instrumentation, such as the Micro-Measurements Model P3, is ideal for use with these sensors, eliminating the need to purchase separate readout devices.

LOW TEMPERATURE RANGE

NETWORK DESIGNATION	OUTPUT SLOPE	SENSOR TEMPERATURE RANGE
LST-10F-350C	10 microstrain/°F	-320° to +100°F
LST-10C-350C	10 microstrain/°C	-200° to +25°C
LST-100F-350C	100 microstrain/°F	-320° to +100°F
LST-100C-350C	100 microstrain/°C	-200° to +25°C

NORMAL TEMPERATURE RANGE

NETWORK DESIGNATION	OUTPUT SLOPE	SENSOR TEMPERATURE RANGE
LST-10F-350D	10 microstrain/°F	-200° to +500°F
LST-10C-350D	10 microstrain/°C	-150° to +260°C
LST-100F-350D	100 microstrain/°F	-200° to +500°F
LST-100C-350D	100 microstrain/°C	-150° to +260°C

Special Use Sensors—Temperature

CLTS-2B TEMPERATURE SENSORS

The Cryogenic Linear Temperature Sensor (CLTS) is recommended for best accuracy over the temperature range of -452° to $+100^{\circ}\text{F}$ (-269° to $+40^{\circ}\text{C}$). The CLTS-2B is a small surface thermometer gage consisting of two thin foil sensing grids laminated into a glass-fiber-reinforced epoxy-phenolic matrix, and electrically wired in series. The two alloys are special grades of nickel and manganin that are processed for equal and opposite nonlinearities in resistance versus temperature characteristics. The CLTS-2B is fabricated with integral printed-circuit terminals to provide strong, convenient attachment points for the leadwires. Gage construction is illustrated at right.

Because of its low thermal mass and thin construction, the CLTS-2B responds quickly and accurately to temperature changes in the surface to which it is bonded. Special design features protect the sensor from damage due to thermal shock, even during plunges from room temperature directly into liquefied gases, including LHe at -452°F (-269°C).

Avoid prolonged exposure of the CLTS-2B to temperatures above $+150^{\circ}\text{F}$ ($+65^{\circ}\text{C}$) as this may adversely affect characteristics of the manganin material. The maximum recommended curing temperature of the bonding adhesive is two hours at $+200^{\circ}\text{F}$ ($+95^{\circ}\text{C}$).

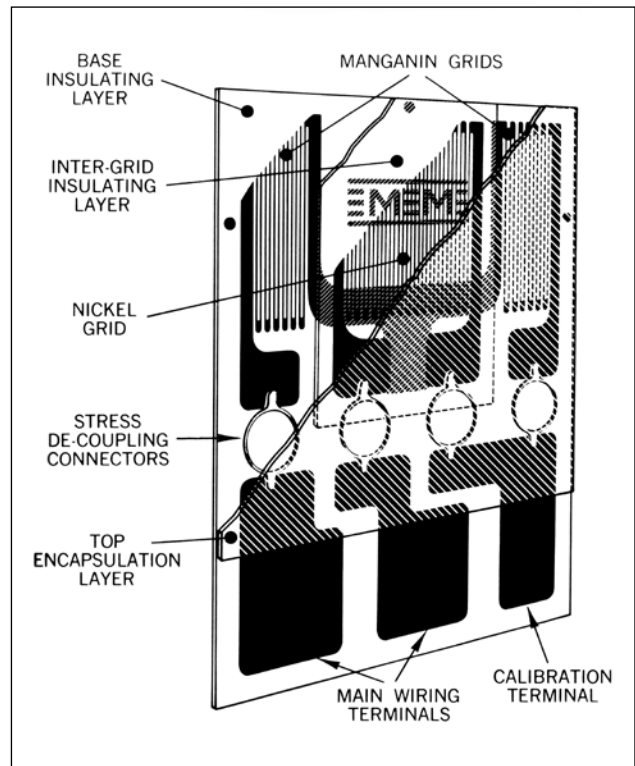

CLTS-2B SENSITIVITY

The nominal resistance of the CLTS-2B is 290.0 ohms $\pm 0.5\%$ at $+75^{\circ}\text{F}$ ($+23.9^{\circ}\text{C}$). The resistance decreases linearly with temperature, reaching a nominal value of 220.0 ohms at -452°F (-269°C). This represents a change of 70 ohms for 527°F , or a slope of 0.1328 ohms per degree F; the corresponding slope on the Celsius scale is

0.2391 ohms per degree C. With proper instrumentation a resolution of 0.01° can be easily achieved. Data readout can be accomplished by directly monitoring resistance change with an appropriate resistance measuring instrument.

GAGE PATTERN AND DESIGNATION Actual size shown	DIMENSIONS					
	GAGE LENGTH	OVERALL LENGTH	GRID WIDTH	OVERALL WIDTH	MATRIX	
					Length	Width
CLTS-2B 	0.130 ES	0.205	0.280 ES	0.280	0.43	0.31
	3.30 ES	5.21	7.11 ES	7.11	10.9	7.9

CLTS MATCHING NETWORKS

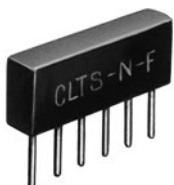

When used in conjunction with bonded strain gages, it is often most convenient to modify the CLTS output with a simple, passive resistance network that can be used with strain gage instrumentation as described with the TG Sensors. The

sensitivity can be adjusted to 10 microstrain per degree C (CLTS-N-C); with a resolution of 0.1° when used with most strain indicators. This type of network also provides a high degree of leadwire compensation. Environmental temperature limits for CLTS Networks are -65° to $+250^{\circ}\text{F}$ (-55° to $+125^{\circ}\text{C}$).

Special Use Sensors—Manganin Pressure Sensor

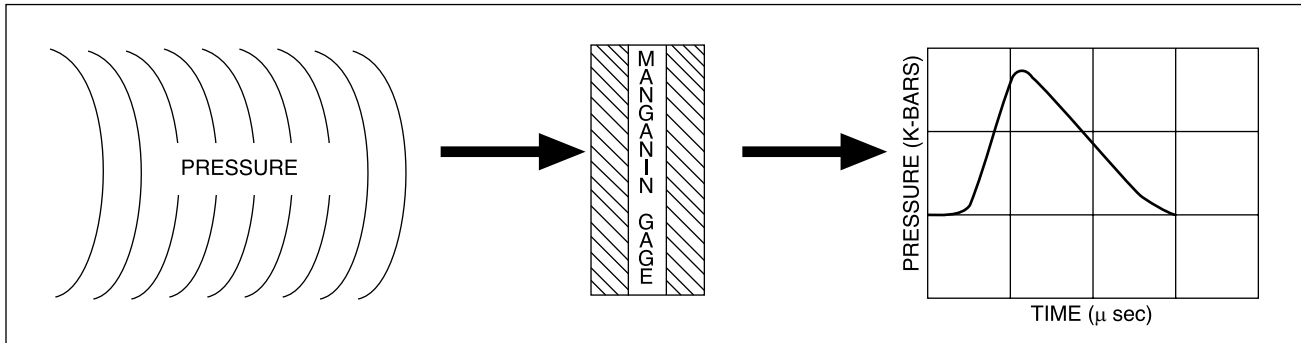

**FOR HIGH-PRESSURE MEASUREMENTS
SHOCK WAVE PROPAGATION • BLAST EFFECT • EXPLOSIVE-FORMING STUDIES
HIGH HYDROSTATIC PRESSURES**

Manganin is a copper-manganese-nickel alloy with a low strain sensitivity, but a relatively high sensitivity to hydrostatic pressure. Resistance change as a function of applied pressure is linear to extremely high pressures. This characteristic has been utilized in the construction of high-range fluid pressure cells using manganin wire for many years.

Manganin gages are used extensively in high-pressure shock wave studies ranging from 1 to over 400 kilobars (1 bar = 14.5 psi = 100 000 N/m²). In conventional applications, the gage is bonded between two flat metallic or polymer plates.

Micro-Measurements offers a large selection of gages for shock wave studies, manufactured from specially treated shunt stock manganin foil. The ultrathin construction offers several advantages over the wire type, including:

- Improved repeatability from gage to gage, due to precisely defined grids manufactured from the same lot of foil.
- Faster response times (nanosecond rise times have been recorded).
- Smaller, high resistance grids.
- Minimal distortion of the pressure wave when mounted in high-modulus materials.

TECHNICAL INFORMATION

Nominal pressure sensitivity of Micro-Measurements manganin foil gages is 0.27% per kilobar (0.0027 ohm/ohm/kb). Long signal transmission cables, low signal levels, and high electrical noise complicate

the measurement. Most of these gages are designed for impedance matching to 50-ohm coaxial cable. The 210AW pattern illustrated has been used with excitation currents exceeding 6 amperes for periods to 100 microseconds.

The 580SF pattern was designed specifically for investigating the effects of sweeping explosive waves. With the target intentionally tilted at a small angle to the wave front, the pressure wave traverses the grid in the direction toward the leads.

Micro-Measurements manufactures manganin foil gages in several backing materials. The backing material is normally selected to minimize the mechanical impedance mismatch within the target.

L backing is a glass-fiber-reinforced epoxy-phenolic approx. 0.002 in (0.050 mm) thick. Although commonly used in the 1- to 15-kilobar range, its usefulness is not limited to this extent. The backing is ideal for use in quartz-phenolic transducers since it does not present a significant impedance discontinuity. L-backed gages may be used in high-mechanical-impedance materials with the understanding that rise-time limitations may exist due to an impedance mismatch between the sensor and the test material. An encapsulated version (Option SP60), with only the tab ends exposed for soldering, is available.

N2 backing is nominally 0.0008 in (0.020 mm) thick polyimide film. This backing is rugged, highly flexible, and easy to handle. It is suited to very-low-kilobar pressure ranges.

J2 backing is an encapsulated version of the N2, with the ends of the tabs exposed.

Special Use Sensors—Manganin Pressure Sensor

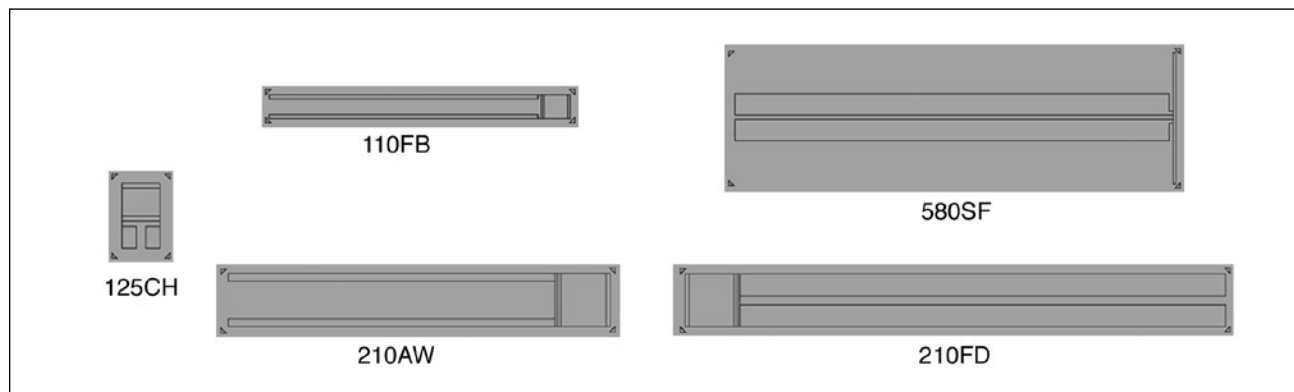

GAGE DESIGNATION		FOIL THICKNESS	DIMENSIONS				inch
			OVERALL PATTERN		ACTIVE GRID		TAB LENGTH
			Length	Width	Length	Width	
LM-SS-110FB-048 LM-SS-110FB-048/SP60 N2M-SS-110FB-048 J2M-SS-110FB-048	0.0002	1.380	0.125	0.110	0.125	1.240	
	0.005	35.05	3.18	2.79	3.18	31.49	
LM-SS-125CH-048 LM-SS-125CH-048/SP60 N2M-SS-125CH-048 J2M-SS-125CH-048	0.0002	0.290	0.175	0.125	0.175	0.100	
	0.005	7.37	4.45	3.18	4.45	2.54	
LM-SS-210AW-048 LM-SS-210AW-048/SP60 N2M-SS-210AW-048 J2M-SS-210AW-048	0.0005	1.750	0.250	0.210	0.250	1.500	
	0.013	44.45	6.35	5.33	6.35	38.10	
LM-SS-210FD-050 LM-SS-210FD-050/SP60 N2M-SS-210FD-050 J2M-SS-210FD-050	0.0005	2.500	0.250	0.210	0.250	2.250	
	0.013	63.50	6.35	5.33	6.35	57.15	
LM-SS-580SF-025 LM-SS-580SF-025/SP60 N2M-SS-580SF-025 J2M-SS-580SF-025	0.0004	2.018	0.600	0.580	0.008	2.000	
	0.010	51.26	15.24	14.73	0.20	50.80	

† All resistance values are $\pm 1\%$, measured on the tab near the grid.

Special Use Sensors—Crack Detection Sensors

CD-Series Crack Detection Gages are designed to provide a convenient, economical method of indicating the presence of a crack, or indicating when a crack has progressed to a predetermined location on a test part or structure. By employing several CD gages, it is also possible to monitor the rate of crack growth; however, Crack Propagation Gages would normally be selected for that purpose.

In some applications, thin copper wires bonded to the test structure are used to provide a low-cost method of detecting crack initiation or propagation. Because of the behavior of copper wire, however, this method suffers from two limitations: (a) the crack tip may progress considerably beyond the wire without breaking the strand, and (b) in areas of high cyclic strains, the wire may fail in fatigue without crack initiation in the specimen. CD-Series Crack Detection Gages are designed to overcome both of these limitations.

CD-Series gages consist of a single strand of high-endurance alloy. A crack propagating beneath the gage will induce local fracture of the sensing strand and open the electrical circuit. When the CD gage is installed at critical locations on a test part or structure and used as a sensing element in a control system, the signal can serve to alter a test sequence or to alert an operator to incipient component failure.

CONSTRUCTION

Two gage constructions are currently available:

The CD-02 is made of beryllium copper alloy laminated to polyimide, and offers a low-resistance sensing element. Select the CD-02 type for maximum conformability to irregular surfaces and ease of soldering, when greatest fatigue life is not required.

The CD-23 type is constructed of isoelastic alloy laminated to a glass-fiber-reinforced backing for applications where the highest endurance is required. The superior fatigue life of the isoelastic alloy allows the CD-23 to be used in high cyclic strain fields without premature failure, while maintaining high sensitivity

to crack formation under the gage. This gage is less conformable than the CD-02 and requires use of SS-Flux for tinning of solder tabs for leadwire attachment.

Crack Detection Gages are available with various strand lengths; from 0.4 in (10 mm) for applications where space is limited, to 2.0 in (50 mm) for use where the direction of crack propagation, or the point of crack initiation, is uncertain.

Resistance of the CD Series is nominally 0.05Ω/mm of active strand length for beryllium copper and 1Ω/mm for isoelastic gages.

The normal operating temperature range is -320° to +250°F (-195° to +120°C).

ADHESIVES

Conventional strain gage adhesives are suitable for bonding CD-Series gages. M-Bond 600, 610, or 43-B are preferred for excellent performance over the widest operating temperature range. However, M-Bond AE-10 and AE-15 are also suitable where in-service temperatures will not exceed +200°F (+95°C). M-Bond 200 is satisfactory for fast installation, but should not be used for long-term testing.

PROTECTIVE COATINGS

Corrosion, which can cause premature filament failure, is greatly accelerated in the presence of high cyclic strain fields. For long-term use, it is essential to protect the crack detection gage from atmospheric corrosion and other contamination.

M-Bond 43-B is an excellent protective coating when the bonding adhesive, leadwire insulation and solder can tolerate the cure temperature. If lower cure temperatures are necessary, M-Bond AE-10 and AE-15 are recommended. When in-service environmental conditions are not extreme, a softer coating may prove perfectly adequate. Either 3140 RTV or M-Coat D would be a good choice in these instances.

For repetitive use on identical structural shapes, special patterns may be designed to fit the expected crack formation area. Contact our Applications Engineering Department for details.

Special Use Sensors—Crack Detection Sensors

CD-SERIES GAGE DESIGNATION

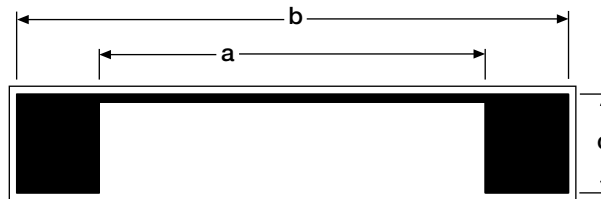
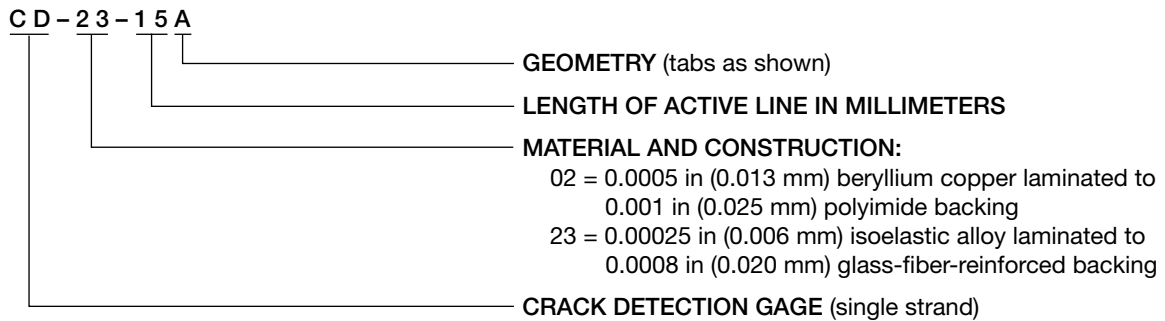

GAGE DESIGNATION	 RoHS COMPLIANT	DIMENSIONS				
		a	b	c	LENGTH	WIDTH
CD-02-10A CD-23-10A		0.40	0.56	0.10	0.60	0.13
		10.2	14.2	2.5	15.2	3.2
CD-02-15A CD-23-15A		0.60	0.76	0.10	0.80	0.13
		15.2	19.3	2.5	20.3	3.2
CD-02-20A CD-23-20A		0.80	0.96	0.10	1.00	0.13
		20.3	24.4	2.5	25.4	3.2
CD-02-25A CD-23-25A		1.00	1.16	0.10	1.20	0.13
		25.4	29.5	2.5	30.5	3.2
CD-02-50A CD-23-50A		2.00	2.16	0.10	2.22	0.13
		50.8	54.9	2.5	56.4	3.2

Special Use Sensors – Crack Propagation Sensors

Crack Propagation Gages provide a convenient method for indicating rate of crack propagation in a test part or structure. The CPA, CPB, and CPC patterns consist of a number of resistor strands connected in parallel. When bonded to a structure, progression of a surface crack through the gage pattern causes successive open-circuiting of the strands, resulting in an increase in total resistance. The CPA pattern incorporates 20 resistor strands; the CPB, with the same basic configuration, incorporates ten. Both series produce stepped increases in resistance with successive open-circuiting as indicated in the charts below. In applications where space permits, the CPC pattern may be preferred because of greater uniformity of increases in total resistance with successive strand fractures.

The resistor strands of the CPD pattern operate independently, each producing an open circuit when fractured. This type of gage allows the user to electrically predetermine a specific point in the fracturing process at which the instrumentation will perform some type of altering function.

GAGE CHARACTERISTICS

Crack Propagation Gages have a nominal gage thickness of only 0.0017 in (0.043 mm). The high-endurance K-alloy foil grid has a single cycle strain range of up to

$\pm 1.5\%$ with a fatigue life of greater than 10^7 cycles at ± 2000 microstrain. The standard backing is a glass-fiber-reinforced epoxy matrix. These gages are useful through the temperature range of -452°F (-269°C) to over $+450^\circ\text{F}$ ($+230^\circ\text{C}$).

Since exact self-temperature compensation is unnecessary in crack propagation studies, all of these gages are supplied in 09 S-T-C.

Crack Propagation Gages feature small copper pads on the tabs for ease of soldering.

ADHESIVES AND PROTECTIVE COATINGS

Crack Propagation Gages should be installed with a solvent-thinned adhesive incorporating a cure temperature of at least $+300^\circ\text{F}$ ($+150^\circ\text{C}$). M-Bond 600 or 610 adhesives are recommended for use over the widest temperature range. Handling tape should not be applied over the grid or soldering tabs during installation. Room-temperature-curing adhesives are not recommended for use with Crack Propagation Gages.

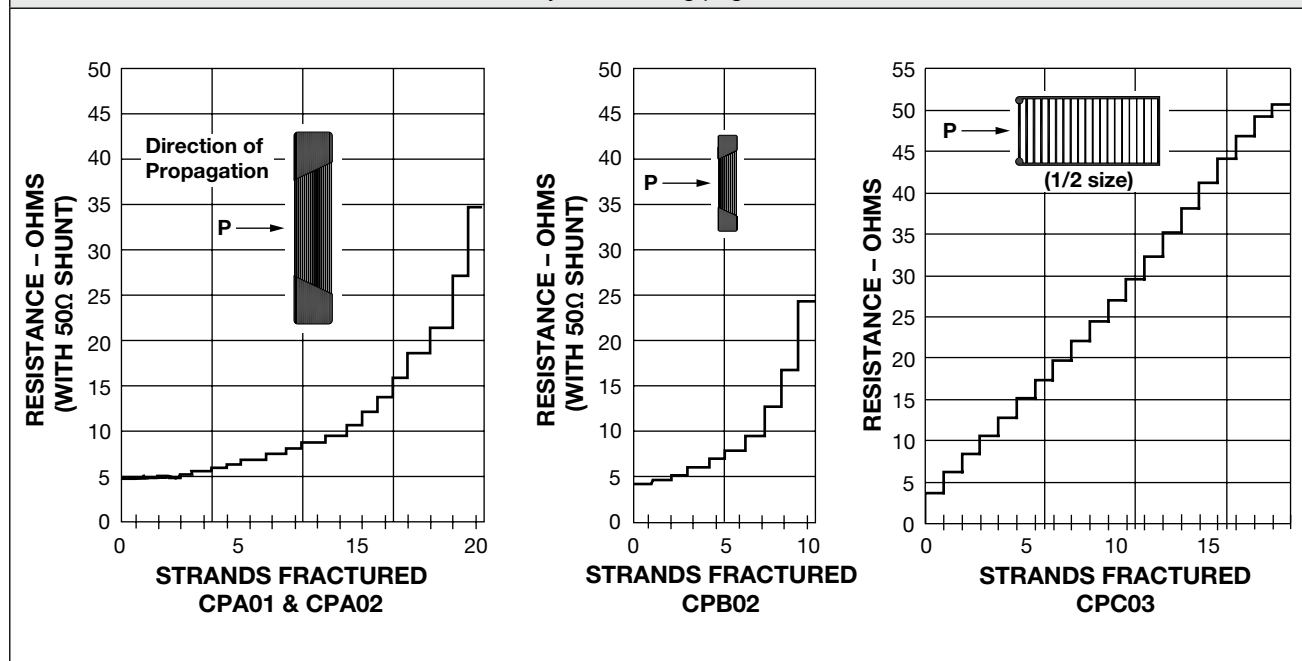

Protective coating selection considerations are similar to those for CD-Series Crack Detection Gages. Refer to appropriate datasheet for protective coating recommendations.

GAGE RESISTANCE CHARTS—See circuitry on following page

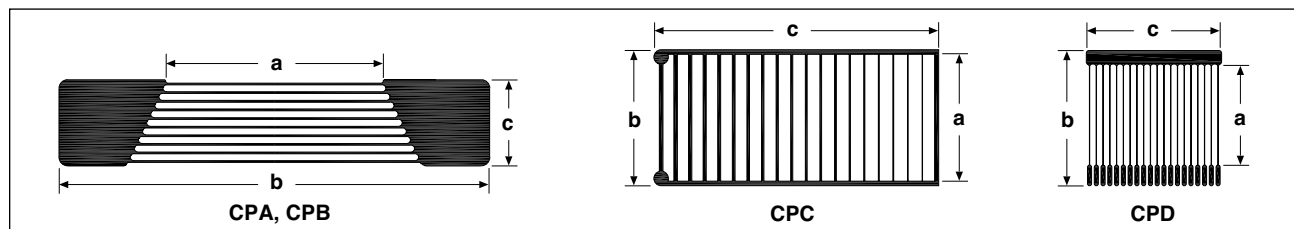

Special Use Sensors—Crack Propagation Sensors

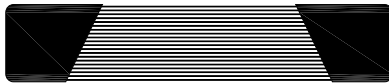
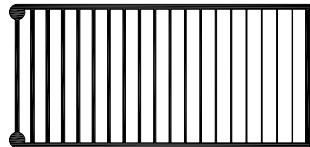
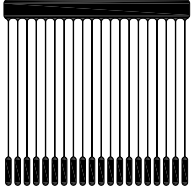

GAGE DESIGNATION AND DESIGNATION	 RoHS COMPLIANT	NOMINAL RESISTANCE IN OHMS	DIMENSIONS				
			a	b	c	MATRIX	
						Length	Width
TK-09-CPB02-005/DP		5	0.25	0.50	0.10	0.56	0.16
			6.4	12.7	2.5	14.2	4.1
			Ten grid lines—0.010 in (0.25 mm) between centerlines.				
TK-09-CPA01-005/DP		5	0.50	1.00	0.20	1.08	0.28
			12.7	25.4	5.1	27.4	7.1
			Twenty grid lines—0.010 in (0.25 mm) between centerlines.				
TK-09-CPA02-005/DP		5	1.00	2.00	0.40	2.08	0.48
			25.4	50.8	10.2	52.8	12.2
			Twenty grid lines—0.020 in (0.51 mm) between centerlines.				
TK-09-CPC03-003/DP		3	0.70	0.75	1.57	0.80	1.62
			17.8	19.1	39.9	20.3	41.1
			Twenty grid lines—0.080 in (2.03 mm) between centerlines.				
TK-09-CPD01-NRA/DP		110	0.75	1.00	1.00	1.11	1.11
			19.1	25.4	25.4	28.1	28.1
			Twenty grid lines—0.050 in (1.27 mm) between centerlines.				

CIRCUITRY

CPA, CPB, AND CPC PATTERNS

An ohmmeter with milliohm sensitivity is a suitable readout instrument. Alternately, a strip chart recorder, connected in the manner shown at right, can be used to obtain a step curve of strands broken versus time.

CPD PATTERN

Low voltage instrumentation can be employed to shut off a motor, sound an alarm, or trigger some other type of alerting function.

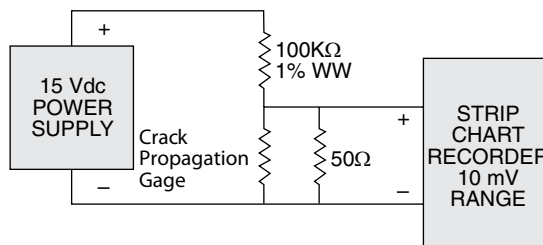

Conventional strain gage instrumentation is not readily adaptable for use with Crack Propagation Gages.

Special Use Sensors – Linear Displacement Sensors

FEATURES

- Infinite resolution
- True output linearity over the entire measurement range
- Low operating forces
- Excellent stability and temperature compensation

DESCRIPTION

Micro-Measurements Linear Displacement Sensors use a fully active 350-ohm strain-gage bridge to sense spindle displacement, giving infinite resolution and excellent linearity. They are compatible with all standard strain-gage instrumentation with bridge excitation from 2 to 10 volts. With a selection of models having full-scale ranges from 1/4 in (5 mm) to 4 in (100 mm), Linear Displacement Sensors feature a unique design that produces maximum operating forces of less than 1 lb (4.4 N). Available with specially designed mounting fixtures, these versatile sensors are ideally suited for use in research, manufacturing and process control applications.

ACCURACY

Micro-Measurements Linear Displacement Sensors produce an output voltage proportional to a captive, guided spindle displacement by means of a 350-ohm strain gage bridge with four active arms. This arrangement provides excellent temperature compensation and linearity.



COMPATIBILITY

Micro-Measurements Linear Displacement Sensors exhibit the same inherent advantages for linearity, versatility and precision as many other strain-gage-based sensors. As such, they are systems-compatible with a wide range of commonly used sensors for pressure, load, acceleration, vibration, etc. and normally utilize the same instrumentation.

OUTLINE DIMENSIONS in inches (millimeters)

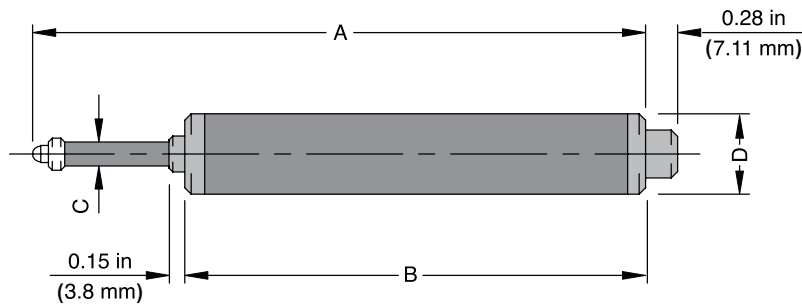

DIMENSION	MODEL				
	HS5	HS10	HS25	HS50	HS100
A	4.10 in (104.2 mm)	4.30 in (109.2 mm)	5.44 in (138.2 mm)	8.48 in (215.4 mm)	14.97 in (380.2 mm)
B	3.49 in (88.6 mm)	3.49 in (88.6 mm)	4.08 in (103.6 mm)	6.11 in (155.2 mm)	10.47 in (266.0 mm)
C _∅	0.19 in (4.8 mm)	0.19 in (4.8 mm)	0.19 in (4.8 mm)	0.19 in (4.8 mm)	0.24 in (6.0 mm)
D _∅	0.69 in (17.4 mm)	0.69 in (17.4 mm)	0.69 in (17.4 mm)	0.69 in (17.4 mm)	1.0 in (25.4 mm)

Special Use Sensors—Linear Displacement Sensors

SPECIFICATIONS					
PARAMETERS	MODEL				
	HS5	HS10	HS25	HS50	HS100
Displacement Range*	0.25 in (6.5 mm)	0.5 in (11.2 mm)	1 in (26 mm)	2 in (51.5 mm)	4 in (102 mm)
Weight	0.31 lb (140 g)	0.31 lb (140 g)	0.33 lb (150 g)	0.44 lb (200 g)	1.10 lb (500 g)
Spring Force*	0.44 lb (200 g)	0.55 lb (250 g)	0.55 lb (250 g)	0.66 lb (300 g)	0.77 lb (350 g)
Excitation	2 to 10 V, AC or DC				
Frequency Response*	5-mm displacement: 100 Hz; 100-mm displacement: 10 Hz				
Rated (F.S.) Output*	4.5 mV/V	5.3 mV/V	7.0 mV/V	3.6 mV/V	5.2 mV/V
Nonlinearity (Best-Fit Method)*	0.35% FS	0.35% FS	0.35% FS	0.35% FS	0.35% FS
Resolution	Infinite				
Bridge Resistance (Nominal)	350 ohms bridge, 100k ohms zero balance				
Temperature Range	+15 to +140°F (-10 to +60°C)				
Temperature Coefficient (%FS)*	Zero <0.006%/°F (<0.01%/°C)		Span <0.006%/°F (<0.01%/°C)		
Termination	0.18 in PVC 7/0.008 (4.5 mm PVC 7/0.2), 4-core shielded, 6.6 ft (2.2 m) long				
Electrical Connections	Input: Red+ Black- ; Output: Green+ White-				

* Typical figures: actual values subject to calibration

FATIGUE LIFE					
MODEL	DISPLACEMENT (NCHES)				
	0.25	0.50	1.00	2.00	4.00
Cycles to Failure (Nominal)					
HS5	5.00E+04				
HS10	5.00E+05	5.00E+04			
HS25	5.00E+06	5.00E+05	5.00E+04		
HS50	5.00E+06	5.00E+06	5.00E+06	5.00E+05	
HS100	5.00E+06	5.00E+06	5.00E+06	5.00E+05	5.00E+04
Signal (mV/V)					
HS5	4.50				
HS10	2.65	5.30			
HS25	1.75	3.50	7.00		
HS50	0.45	0.90	1.80	3.60	
HS100	0.32	0.65	1.30	2.60	5.20

* Please note that recommended displacements are indicated by shading

Special Use Sensors – Cable-Extension Displacement Sensors

FEATURES

- Full-scale ranges from 5 to 50 inches
- Rugged, low profile design
- Switch-selectable potentiometer and Wheatstone bridge output circuits
- Standard RJ-45 electrical connections
- Compatible with all Micro-Measurements strain gage and high-level-signal instrumentation
- Easy to install and use



DESCRIPTION

The Micro-Measurements Cable-Extension Displacement Sensor provides a voltage signal linearly proportional to the extension of a retractable stainless steel cable. Used for indicating the displacement of the test structure, member or part to which the cable is attached, installation is quick and easy. Simply attach the base of the sensor to a reference surface, the cable to the component being displaced, and the electrical leads to any instrument accepting strain-gage or high-level signal inputs. With the certified calibration data and wiring instructions provided with each sensor, you will be making displacement measurements in minutes.

SPECIFICATIONS							
PARAMETER	MODEL						UNIT
	CDS-05	CDS-10	CDS-20	CDS-30	CDS-40	CDS-50	
Measurement Range	5 (127)	10 in (254)	20 (508)	30 (762)	40 (1016)	50 (1270)	in (mm)
Accuracy	0.25	0.15	0.10	0.10	0.10	0.10	% FS
Resolution	Analog (effectively infinite, limited only by instrumentation)						—
Repeatability	Greater of ± 0.001 in (± 0.025 mm) or 0.02% FS						—
Cable Retraction Force (min)	3.5 (1.0)	8.4 (2.3)	8.4 (2.3)	6.3 (1.8)	4.2 (1.1)	3.5 (1.0)	oz (N)
Cable Extension Force (max)	6.5 (1.8)	15.6 (4.3)	15.6 (4.3)	11.7 (3.3)	7.8 (2.2)	6.5 (1.8)	oz (N)
Cable Acceleration	3	11	11	5	4	3	g
Vibration	Up to 10, 0–2000						g, Hz
Shock	100, 0.1						g, mS
Sensor	Plastic-hybrid precision potentiometer						
Resistance	500						ohms
Maximum Supply Voltage – Potentiometer	30						V
Maximum Supply Voltage – Bridge	30						V
Output – Bridge	3.0 typical						mV/V FS
Case	Powder-painted aluminum alloy						
Cable	Nylon-coated stainless steel, 0.019 in [0.48 mm] diameter						
Electrical Connector	RJ-45 receptacle						
Weight	2 (1) typ.						lb (kg)
Operating Temperature	–40 to +200 (–40 to 93)						°F (°C)
TC of Sensor	88 (157)						ppm/°F (ppm/°C)
Humidity	100 at 90°F (32°C)						% RH

Special Use Sensors—Cable-Extension Displacement Sensors

OUTLINE DIMENSIONS in inches

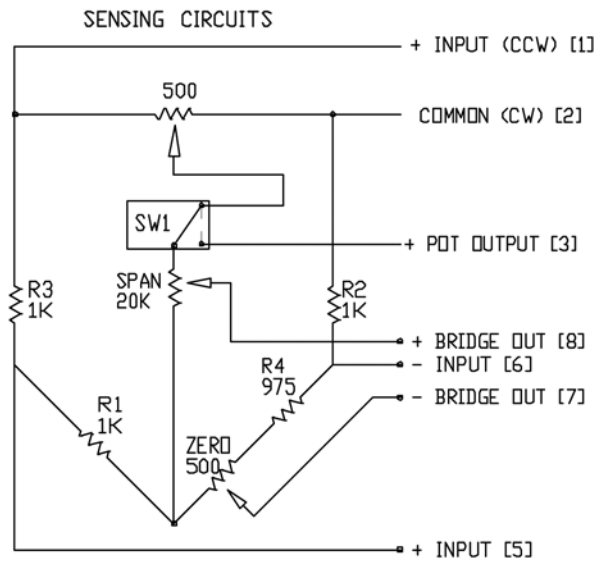

MEASUREMENT RANGE (INCHES)	5	10	20	30	40	50
DIMENSION 'A'	0.16	0.65	0.65	0.43	0.35	0.16

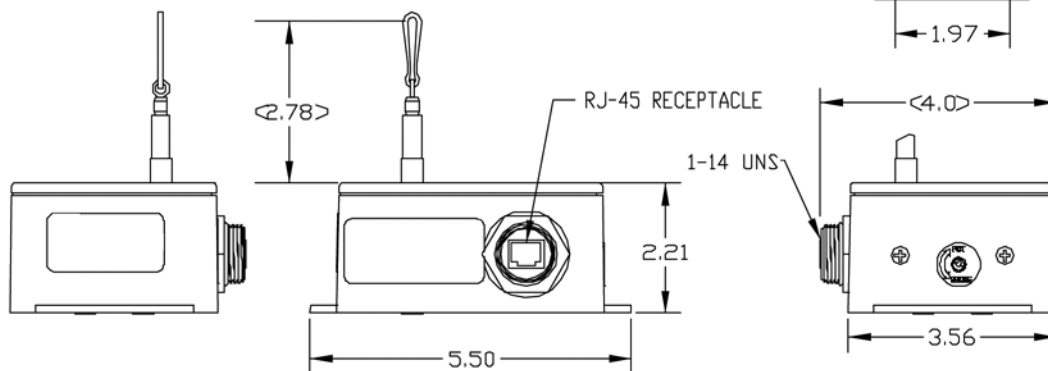
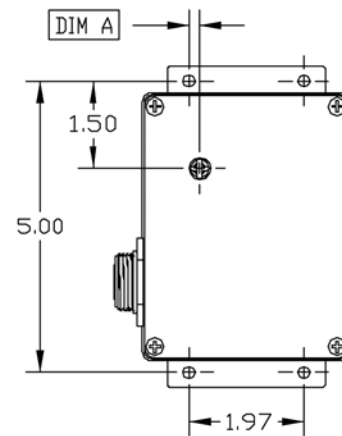
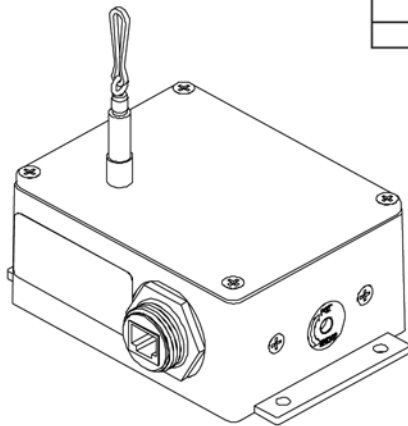

Strain Gage Accessories and Instruments

Micro-Measurements Strain Gage Accessories

Micro-Measurements strain gages are produced under rigidly controlled manufacturing conditions, with the utmost care and attention given to ensuring the high level of quality for which these gages have gained world-wide recognition. However, the gages' full potential for accurate strain measurement can be realized only when they are properly installed. There are, in fact, three principal components in every strain gage installation: (1) The strain gage itself, (2) the tools, materials, and supplies (accessories) needed to install the gage, and (3) the techniques employed in performing the installation. Professional stress analysts have learned from experience that compromising any of these may lead to compromising the quality of the installation and the accuracy of the strain data.

The well-established formula for making consistently successful strain gage installations is quite simple:

- Select high-quality precision strain gages.
- Select professional-caliber accessories which have been laboratory-tested and field-proven for effectiveness and compatibility with the strain gages.
- Follow the installation procedures recommended by the manufacturer of the gages and accessories.

A small sample of the Micro-Measurements strain gage installation accessories is featured on the following two pages. As indicated, the appropriate materials, supplies, and tools are available for each important step in the gage installation process—from preparing the surface of the test piece to applying a protective coating over the









bonded and wired gage. All accessory items, whether manufactured directly by Micro-Measurements or specified for purchase from an outside supplier, are of the highest quality, and have been designed or selected specifically to help ensure successful installation of Micro-Measurements strain gages.

Regular users of strain gages will want to request a copy of Micro-Measurements Strain Gage Accessories databook. This fully illustrated catalog describes the complete line of gage installation accessories and related equipment. In addition to detailed product descriptions and specifications, it includes, where applicable, extensive recommendations for the appropriate selection and application of the accessories. Micro-Measurements Strain Gage Accessories databook is available on request from our Applications Engineering Department. A complete listing is available on our website.

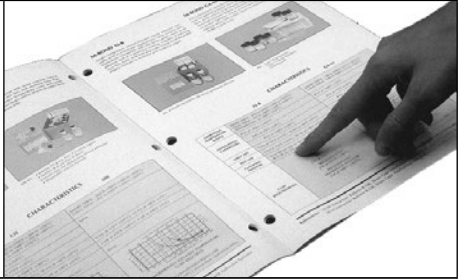

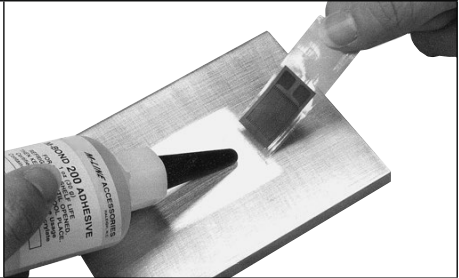
Micro-Measurements Strain Gage Accessories

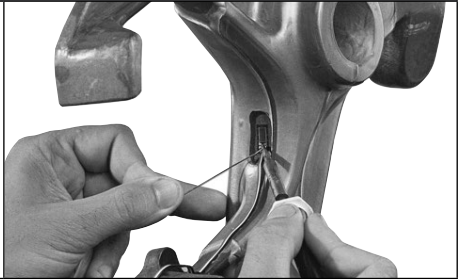
SIX SIMPLE STEPS TO SUCCESSFUL STRAIN GAGE INSTALLATION

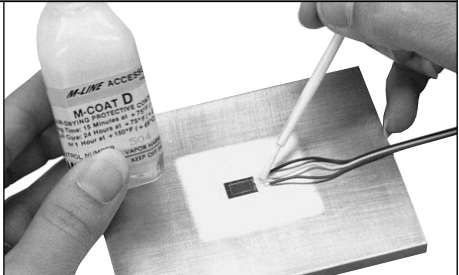
1. Surface Preparation		
	<p>CSM Degreaser M-Prep Conditioner A M-Prep Neutralizer 5A Silicon-Carbide Paper Cotton Tip Applicators Gauze Sponges</p>	
2. Adhesive Selection		
	<p>M-Bond 200 M-Bond AE-10 M-Bond AE-15 M-Bond 600 M-Bond 610</p>	
3. Gage Handling and Bonding		
	<p>Gage Handling Tape Mylar® Tape Spring Clamps Teflon® Film Silicone Rubber Gum Pads Application Tools</p>	
4. Leadwire Attachment		
	<p>Solder Terminals Wires, Cables – Solid, Stranded, Tinned Solders Soldering Station Wiring Tools</p>	
5. Protective Coating Application		
	<p>M-Coat A Polyurethane M-Coat B Nitrile Rubber M-Coat C Silicone Rubber M-Coat D Acrylic M-Coat W-1 Microcrystalline Wax</p>	

Micro-Measurements Strain Gage Accessories

6. Gage Installation Tester



Reads insulation resistance (leakage) to 20 000 M Ω with 15 VDC.
Measures deviation of installed gage resistance from precise standards to a resolution of 0.02%.
Auxiliary ohmmeter scale for troubleshooting questionable installations.
Reads with the push of a button.
Verifies the complete gage circuit including leadwires.



GENERAL APPLICATION KITS

It is often of greatest convenience for the strain gage user to purchase all of the needed accessory supplies and materials in a single package.

GAK-2 Series Kits provide specific selections of M-LINE accessories for making basic strain gage installations with the M-Bond 200, AE-10, or 610 Adhesives.

The ultimate in gage installation capability is provided by the **MAK-1, Master Strain Gage Application Kit**. The MAK-1 includes all of the supplies and special tools necessary for making a wide range of gage installations for both laboratory and field applications.



GAK-2 Series Kit



MAK-1 Master Strain Gage Application Kit

INSTRUCTIONAL MATERIALS

Because technique is such an important ingredient in successful strain gage installation, detailed **Instruction Bulletins** have been prepared for virtually all Micro-Measurements strain gage installation products.

In addition, a library of **Tech Notes** and **Application Notes** is available for reference on a broad range of subjects within Strain Gage Technology.

Application Notes present practical strain gage application techniques for “out-of-the-ordinary” situations, and represent, as much as possible, a practical “how-to” approach to strain gage installation.

Tech Notes contain in-depth technical treatments of specific subjects having direct or indirect bearing on the successful application of stress/strain measurement technology.

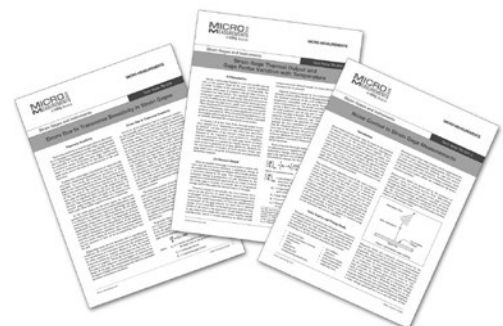

Considerations for Instrument Selection

STRAIN INDICATORS AND CALIBRATORS



Basic instrumentation requirements call for stability, accuracy and high resolution when making measurements under static loading conditions, and particularly where measurements are to be taken over long periods of time. Micro-Measurements offers our Model P3 Strain Indicator and Recorder and D4 Data Acquisition Conditioner to meet these demanding criteria.

The Model P3 Strain Indicator and Recorder is a portable, battery-operated instrument while our D4 is a USB-powered instrument that connects to a personal computer. Both are capable of simultaneously accepting four inputs from quarter-, half-, and full-bridge strain-gage circuits, including strain-gage-based transducers. A highly stable measurement circuit, regulated bridge excitation supply, and precisely settable gage factor enable measurements of $\pm 0.1\%$ accuracy and 1 microstrain resolution. The P3 can also be configured and operated directly from your PC with a separate software application included with each instrument. The D4 also has a separate software application and is programmable for custom applications.

SIGNAL CONDITIONING AMPLIFIERS



When signals are produced by dynamically applied loads at frequencies above 0.1 Hz, or are transients, measuring instrumentation requires adequate frequency response, and a wide amplifier gain range for output to the appropriate recording or display device. Such an instrument consists of an amplifier and signal conditioner with a built-in or shared power supply. Individual units are normally required for each channel when simultaneous recording or multiple channels are needed. With the output sent to a suitable display device, signal conditioning amplifiers can be used for making long-term measurements under static loading conditions, when maximum stability and accuracy are not primary considerations.

The 2100, 2200, and 2300 Systems accept low-level signals, and condition and amplify them into high-level

outputs suitable for multiple channel, simultaneous, dynamic recording. All of these systems can be used in conjunction with a variety of recording devices.

DIGITAL DATA SYSTEMS



Depending on their design, digital data systems can be used for measurement of static, dynamic, or both kinds of signals. Micro-Measurements offers three digital data systems, each controlled with StrainSmart® software and other third-party software.

System 7000 is a high performance dynamic data acquisition instrument with measurement accuracy of $\pm 0.05\%$ of full scale. Each sensor card employs a 24-bit analog to digital converter enabling 0.5 microstrain resolution. Scan rates up to 2048 samples per second are available for simultaneous reading of all sensor inputs. A combination of analog and flexible Finite Impulse Response (FIR) filters are available to provide adequate anti-alias filtering at all scanning rates. Electronically selectable bridge completion resistors allow the user to choose between 120-, 350-, and 1000-ohm strain gages through software selection. System 7000 is capable of self-calibration with a removable calibration reference.

System 8000 is a versatile, precision data acquisition instrument system intended for static and dynamic test and measurement applications. The system includes a scanner with 8 channels of data acquisition. A 10-foot crossover Ethernet cable is also included. The scanners may be used separately or up to 16 scanners can be used concurrently for a maximum of 128 channels. Each channel can be configured, via software, to accept signals from strain gages or strain-gage-based transducers, thermocouples, or high level voltage sensors. Strain gage channels accept full-, half-, or quarter-bridge configurations and have the required bridge completion components for 120-, 350-, and 1000-ohm bridges. Each scanner operates independently; multiple scanners are not synchronized. The data is processed in a modern 24-bit digital signal processor and filtering is performed using Finite Impulse Response (FIR), multi-stage filters. This provides excellent noise rejection and stability and unsurpassed measurement accuracy.

System 9000 from Micro-Measurements is a versatile, precision data acquisition instrument system intended for dynamic test and measurement applications. The system includes a scanner with 12 channels of strain gage (strain gauge) data acquisition and 4 configurable slots for high level voltage sensors, thermocouples, and piezoelectric transducers (charge mode and voltage mode). Strain gage (strain gauge) channels accept full-, half-, or

Considerations for Instrument Selection

quarter-bridge configurations and have the required bridge completion components for 120-, 350-, and 1000- ohm bridges. Three scanners can be connected concurrently, providing 48 fully synchronized channels of data acquisition (36 strain gage and 12 configurable). The data is processed in a modern 24-bit digital signal processor and filtering is performed using Finite Impulse Response (FIR), multi-stage filters. This provides

excellent noise rejection and stability and unsurpassed measurement accuracy. The Model 9000-16-SM Scanner communicates with a host personal computer (PC) via a DHCP auto configured Ethernet connection. Micro-Measurements StrainSmart® software is optimal for configuring, controlling, and acquiring data from the System 9000.

INSTRUMENT SELECTION GUIDE

STRAIN INDICATORS AND CALIBRATORS						
Instrument	Display	Operation	Bridge Excitation	Input Power	Multi-Channel	Remarks
P3	Digital	Manual, Direct-Reading	1.5 VDC	Battery, USB, or AC Adapter	Selectable	Portable, 4-Channel, 0.1% Accuracy
D4	Host PC	PC Controlled via USB	1.5 VDC	USB	Selectable	4-Channel, 0.1% Accuracy

SIGNAL CONDITIONING AMPLIFIERS						
Instrument	Frequency Response ⁽¹⁾	Output (±)	Amplifier Gain	Bridge Excitation	Input Power	Remarks
2100	DC 15 kHz -3 dB	10 V at 100 mA	Continuously Variable 1-2100	DC 0.5-12 V	AC	High Performance Amplifier for Simultaneous Dynamic Recording
2200	DC 50 kHz -0.5 dB DC 100 kHz -3 dB	10 V at 10 mA and 1 VRMS at 10 mA	Continuously Variable 1-3300	DC: 0.5-15 V or 0.5-30 mA	AC	High Performance, for Demanding Environments
2300	DC 60 kHz -0.5 dB DC 145 kHz -3 dB	10 V	Continuously Variable 1-11,000	DC: 0.7-15 V (11 steps) 0.2-7 V Variable	AC	High-Frequency Response Multi-Feature Signal Conditioner

⁽¹⁾ Typical—see specific product bulletin and/or instruction manual for detailed performance specifications.

DIGITAL DATA SYSTEMS						
Instrument	Operating Mode ⁽²⁾	Channels	Scanning Rate	Bridge Excitation ⁽³⁾	Input Power	Remarks
7000	Stationary, Online	Unlimited (in increments of 8)	10-2048 Samples/Sec/ Channel	0-10 VDC Programmable	DC (AC Optional)	Programmable Digital Filters to 800 Hz
8000	Stationary, Online	1-128 (in increments of 8)	10-1000 Samples/Sec	0-10 VDC Programmable	DC (AC Optional)	Anti-Alias Low-Pass Filter
9000	Stationary, Online	1-48 (in increments of 16) ⁽⁴⁾	5-50,000 Samples/Sec/ Channel	0-10 VDC Programmable	DC (AC Optional)	Anti-Alias Low-Pass Filter

⁽²⁾ All systems can be operated with StrainSmart software for data acquisition, storage, reduction, and presentation, or with other third-party software.

⁽³⁾ Strain gage cards only.

⁽⁴⁾ System 9000, up to 12 of the 16 channels per unit can be strain gage inputs.

Considerations for instrument selection are provided on the previous page for all general-purpose instrumentation and data systems produced by Micro-Measurements. Additionally, our Applications Engineering staff is always available to assist you in selecting the right instrument for your specific applications.



Gage Series—
Stress Analysis Gages..... 154
Optional Features—
Stress Analysis Gages..... 162

Technical Data for General-Use Strain Gages

Technical Data

GAGE SERIES

All Micro-Measurements strain gages incorporate precision foil grids mounted on organic backing materials. The strain-sensing alloys and backing materials cannot be arbitrarily combined in specifying a gage type. Instead, a selection must be made from among the available gage systems, or series, where each series generally incorporates special design or construction features, as well as a specific combination of alloy and backing material.

Descriptions of all standard gage series are given on the following pages, along with performance specifications and application notes. The information includes, in each case, the alloy and backing combination employed, as well as the principal construction features common to the series. The allowable strain range is specified, and operating temperature ranges are recommended for different types of applications.

The plots of cyclic strain level versus number of cycles shown for each series represent general guidelines for the nominal fatigue characteristics. This data is a function of gage size with the upper curve indicative of larger gage patterns, and the lower curve of smaller gage patterns. Since the fatigue life of a strain gage is subject to special interpretation, reference should be made

to Micro-Measurements Tech Note TN-508, "Fatigue Characteristics of Micro-Measurements Strain Gages", for a full understanding of the plotted data.

The fatigue curves on the following pages correspond to fully reversed strain levels. They can also be applied, approximately, to unidirectional strains and to combinations of mean and variable strains by derating the peak-to-peak amplitude by 10%. As an example, a fully reversed strain range of $\pm 1500\mu\epsilon$ is approximately equivalent in gage fatigue damage to strain levels of:

0 to $+2700\mu\epsilon$

0 to $-2700\mu\epsilon$

-200 to $+2500\mu\epsilon$

However, a mean strain which increases in the tensile direction during cycling will lead to much earlier failure.

It must be noted that all performance specifications for strain gages are nominal, since the behavior of a particular gage may be modified by installation or application circumstances. Moreover, the specifications apply primarily to gages of 0.125 in (3 mm) gage length and larger, and without optional features, unless otherwise indicated.

EA SERIES

EA-Series constantan gages are widely used in general-purpose experimental stress analysis applications. The basic gage is of open-faced construction on a 0.001 in (0.025 mm) tough, flexible cast polyimide backing. The strength and heat resistance of this backing provide excellent handling and performance qualities. This series is available in the widest range of patterns and will usually be the lowest in cost for a particular pattern design. A large number of options may be obtained for EA-Series gages, covering various forms of lead attachment and protective encapsulation. The backing is treated for strong bond formation with all standard strain gage adhesives. Strain limits are approximately $\pm 5\%$ for gages of 1/8 in (3 mm) or greater gage length and $\pm 3\%$ for smaller sizes.

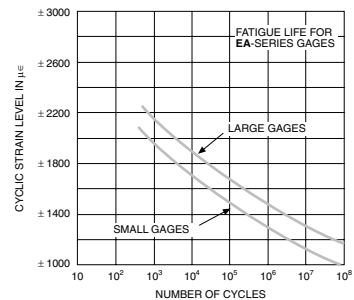

OPERATING TEMPERATURES FOR EA-SERIES GAGES

The thermal output of constantan increases rapidly below -50°F (-45°C). Static measurements become difficult if temperatures are varying.

Positive zero drift of constantan alloy increases significantly above $+150^\circ\text{F}$ ($+65^\circ\text{C}$) for single active gages in static measurements. Use half-bridge or full-bridge circuits when possible.

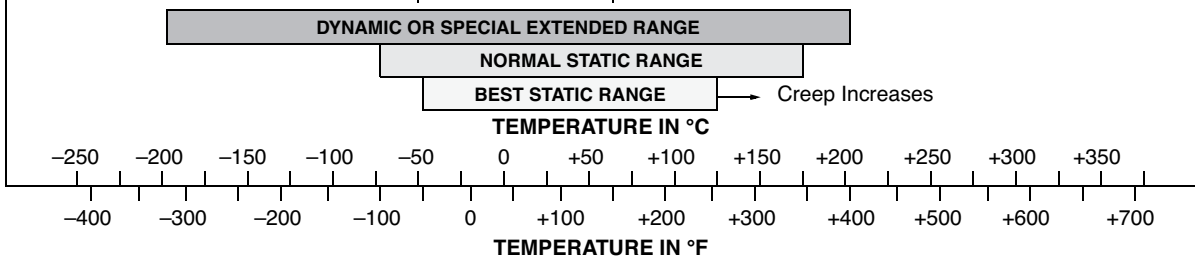

Technical Data

CEA SERIES

CEA-Series gages are the most widely accepted for use in general-purpose experimental stress analysis applications in the world today. These polyimide encapsulated constantan gages feature large, rugged, copper-coated tabs. This construction provides optimum capability for attaching leadwires directly to the tabs, eliminating the need for separate terminals. In most applications, the CEA Series is preferred over the EA Series with options such as E, L, LE and W. Nominal single-plane gage thickness is 0.0027 in (0.069 mm); stacked rosettes, 0.0039 in (0.099 mm). The extremely tough but flexible cast polyimide carrier can be contoured to almost any radius. Strain limits are approximately $\pm 5\%$ (50 000 $\mu\epsilon$) for gage lengths 1/8 in (3 mm) or greater, and $\pm 3\%$ for smaller sizes.

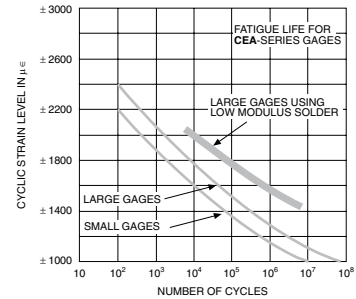

OPERATING TEMPERATURES FOR CEA-SERIES GAGES

The thermal output of constantan increases rapidly below -50°F (-45°C). Static measurements become difficult if temperatures are varying.

Positive zero drift of constantan alloy increases significantly above $+150^{\circ}\text{F}$ ($+65^{\circ}\text{C}$) for single active gages in static measurements. Use half-bridge or full-bridge circuits when possible. Stacked rosettes are limited to a maximum operating temperature of $+150^{\circ}\text{F}$ ($+65^{\circ}\text{C}$).

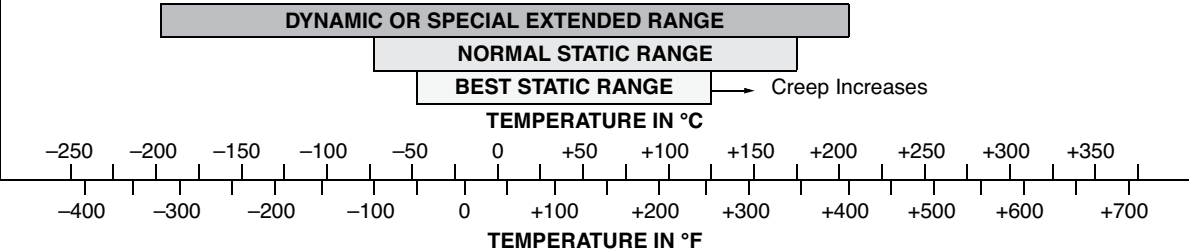

N2A SERIES

N2A-Series gages are open-faced constantan on a special, thin, laminated polyimide backing. The backing is very flexible and tough. Backing thickness is approximately 0.0008 in (0.020 mm), and the backing has been specially treated for optimum bond formation. The N2A Series has an elongation capability of approximately $\pm 3\%$. These gages are intended for use in elastic strain fields. This series is primarily available for certain large gage patterns because its flatness eases handling.

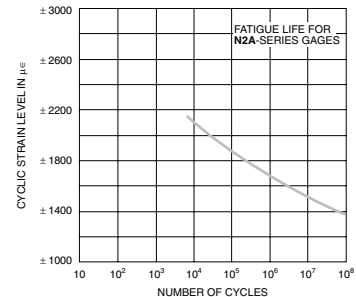

OPERATING TEMPERATURES FOR N2A-SERIES GAGES

The thermal output of constantan increases rapidly below -50°F (-45°C). Static measurements become difficult if temperatures are varying.

Positive zero drift of constantan alloy increases significantly above $+150^{\circ}\text{F}$ ($+65^{\circ}\text{C}$) for single active gages in static measurements. Use half-bridge or full-bridge circuits when possible.

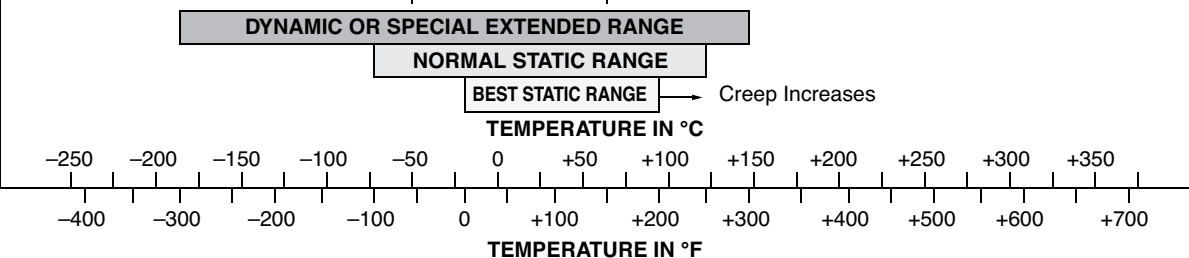

Technical Data

C2A SERIES

C2A series gages are designed to save time in gage installation. They are fully encapsulated constantan alloy gages with pre-attached 3-conductor instrument cables. Flexible and rugged polyimide film backing and encapsulation allows these gages to be installed on almost any radius. Pre-attached 10-ft (3 m) 26-AWG stranded instrument cable requires no soldering. Economical and easy to install, the C2A series is available in linear, shear, Tee-Rosette and Rectangular Rosette patterns. Nominal gage thickness 0.002 in (0.05 mm). Jumper wire between gage and instrument cable is 34 AWG single-conductor, polyurethane insulated copper wire 1 in (25 mm) long. Solder used for the connections is +430°F (+220°C) melting point, lead-free type. Strain limits $\pm 3\%$.

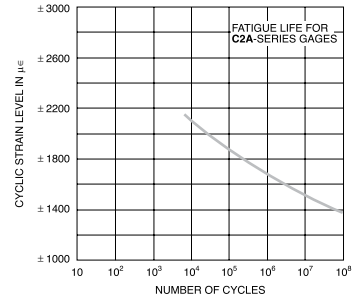

OPERATING TEMPERATURES FOR C2A-SERIES GAGES

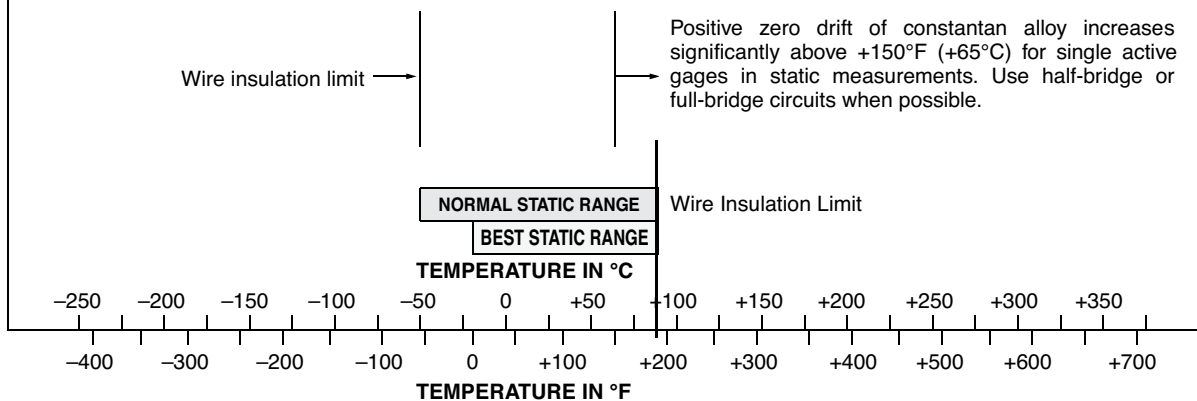

L2A SERIES

L2A series gages are fully encapsulated constantan alloy gages with pre-attached nickel-clad copper lead ribbons. Flexible and rugged polyimide film backing and encapsulation allows these gages to be installed on almost any radius. Available in linear, shear, Tee-Rosette and Rectangular Rosette patterns, L2A gages are the lowest cost pre-leaded gage series, and also save you time in gage installation by eliminating direct soldering on the gage foil. Preattached leads are 1.2 in (30 mm) long, 0.016 in (0.4 mm) wide and 0.002 inch (0.05 mm) thick nickel-clad copper ribbon soldered with +430°F (+220°C) lead-free solder. Nominal gage thickness is 0.002 in (0.05 mm). Strain limits $\pm 3\%$.

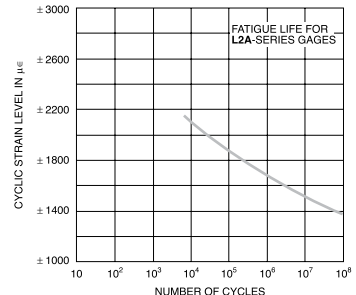

OPERATING TEMPERATURES FOR L2A-SERIES GAGES

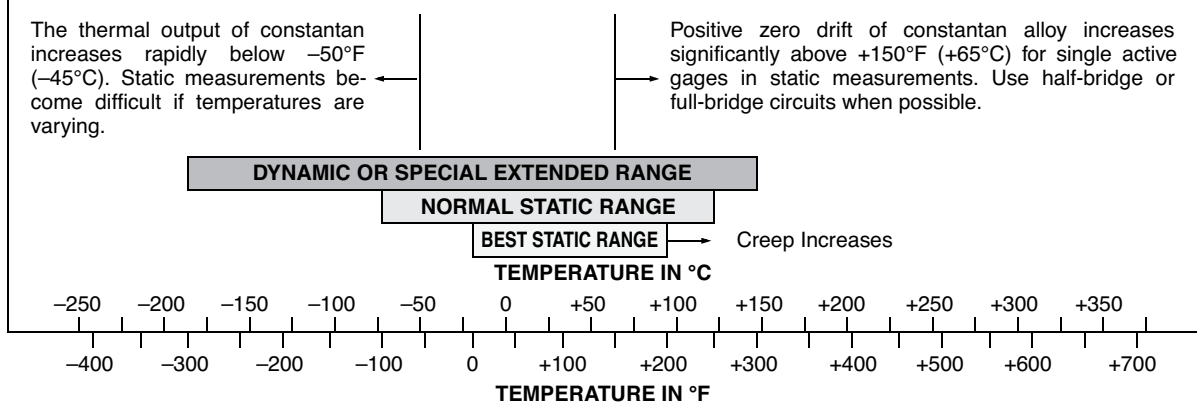

Technical Data

WA SERIES

WA-Series gages are fully encapsulated constantan, equipped with integral, high-endurance beryllium copper leadwires. The backing and encapsulation matrix consists of a high-temperature epoxy-phenolic resin system reinforced with glass fibers. Overall gage thickness is approximately 0.0028 in (0.071 mm). The WA construction provides a gage that is strong and easy to handle, though not as flexible as the EA type. The backing is treated for strong bond formation with all standard strain gage adhesives. The strain range is limited to approximately ± 1 to 2% by the hard, creep-resistant matrix. WA-Series gages are primarily intended for high accuracy measurements over wider temperature ranges and in more difficult environments than other forms of constantan gages. Option W is available on some WA-Series gages, but will restrict the fatigue life to some extent. Heat-curing adhesives such as M-Bond 600 or 610 are recommended when full-temperature-range capabilities are required.

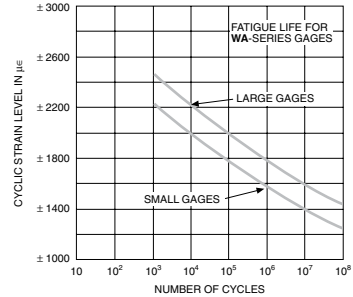

OPERATING TEMPERATURES FOR WA-SERIES GAGES

The thermal output of constantan increases rapidly below -50°F (-45°C). Static measurements become difficult if temperatures are varying.

Positive zero drift of constantan alloy increases significantly above $+150^{\circ}\text{F}$ ($+65^{\circ}\text{C}$) for single active gages in static measurements. Use half-bridge or full-bridge circuits when possible.

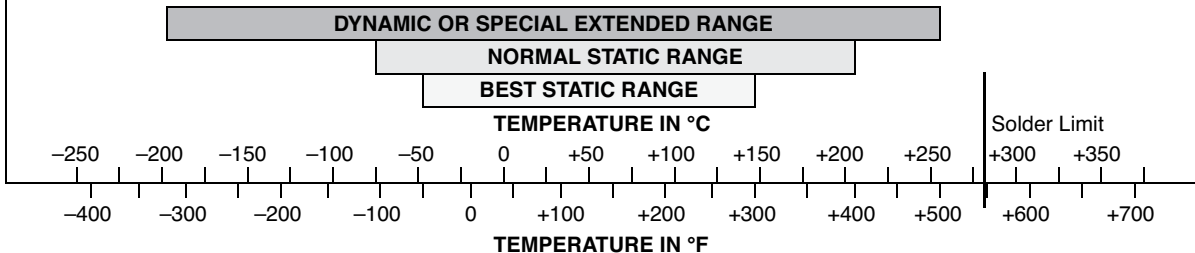

SA SERIES

SA-Series gages are fully encapsulated constantan similar to WA-Series gages, but with solder dots instead of leadwires. The matrix is somewhat thinner than the WA type, with an overall gage thickness of approximately 0.002 in (0.05 mm). The solder is a lead-tin-silver alloy which melts at approximately $+570^{\circ}\text{F}$ ($+300^{\circ}\text{C}$). These gages are typically used in stress analysis applications when mounting space is restricted. The solder dot connections permit small jumper wires to be attached from any direction, and the matrix can be field-trimmed very close to the pattern since no integral leadwires are involved. Because of the exposed solder dots, SA-Series gages are not as well protected in extreme environments as the WA type. The WA Series is superior in maximum temperature capability and fatigue life. No leadwire options are available in this series. Strain limits are approximately ± 1 to 2%. Heat-curing adhesives such as M-Bond 600 or 610 are recommended for full-range performance.

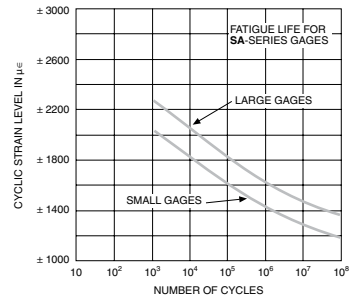

OPERATING TEMPERATURES FOR SA-SERIES GAGES

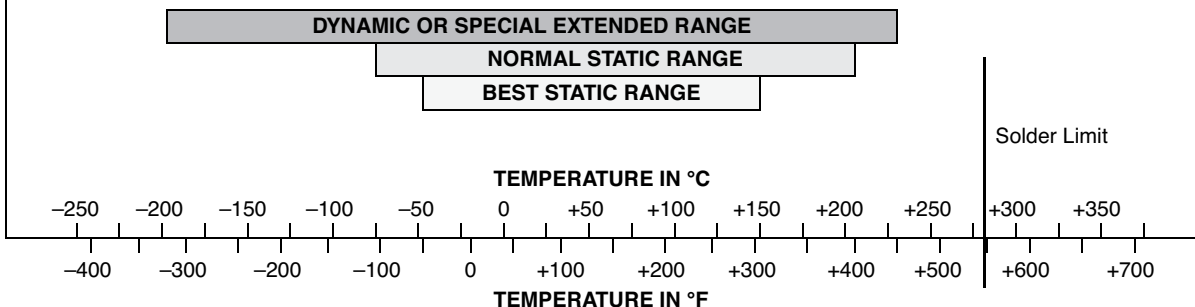

Technical Data

EP SERIES

EP-Series gages are specifically designed for use in the measurement of large strains, >3–5%. The basic gage is of open-faced construction on a 0.001 in (0.025 mm) tough, flexible, high-elongation cast polyimide backing. The sensing grid is a special grade of fully annealed constantan foil for maximum ductility. This gage series is available in 08 and 40 compensations, for use on metals and plastic, respectively. Exact values of self-temperature compensation are usually not important in post-yield work because the thermal output error is very small compared to the large strain levels being measured. Strain limits for EP-Series gages are approximately $\pm 20\%$ for gages of 1/8 in (3 mm) or greater gage length, and $\pm 10\%$ for smaller sizes. Optional features generally degrade elongation capabilities. EP-Series gages can be obtained on special order with all options offered on the equivalent EA-Series pattern. M-Bond A-12 adhesive is recommended for full elongation capability.

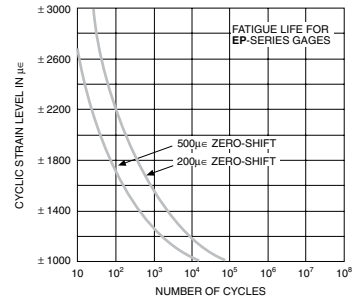

OPERATING TEMPERATURES FOR EP-SERIES GAGES

Elongation capability of gage and adhesive is restricted at temperatures below -50°F (-45°C).

Currently adhesive-limited

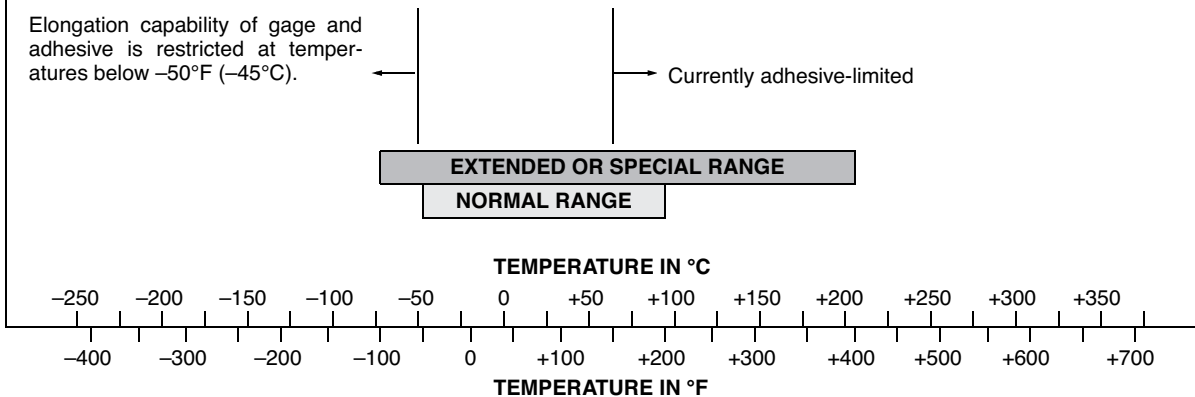

ED SERIES

ED-Series gages are used in general-purpose dynamic-only strain measurement. They are openfaced construction on a thin, 0.001 in (0.025 mm), tough, flexible cast polyimide backing. The isoelastic grid alloy has a high strain sensitivity, and gage factor is approximately 3.2. The extremely high temperature coefficient of resistance (thermal output of approximately $80\mu\epsilon/^{\circ}\text{F}$ ($145\mu\epsilon/^{\circ}\text{C}$)) does not normally permit static measurements to be made with isoelastic gages. The outstanding features of the ED Series are excellent handling properties, high flexibility, good fatigue life, and relatively low cost. A wide range of options is available, covering various forms of lead attachment and protective encapsulation. Leadwires must be handled and installed with care to avoid reduction in fatigue life. All isoelastic gages tend to generate error signals in magnetic fields, since the alloy is both magnetic and magnetostrictive. Strain limits for ED gages are approximately $\pm 1\%$, but increasing nonlinearity above $\pm 5000\mu\epsilon$ normally restricts this type of gage to measurement of dynamic, elastic strain levels.

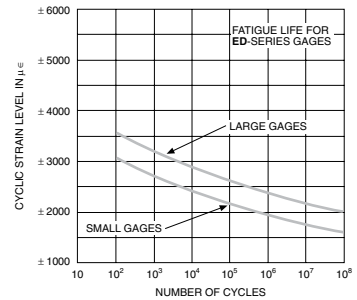

OPERATING TEMPERATURES FOR ED-SERIES GAGES

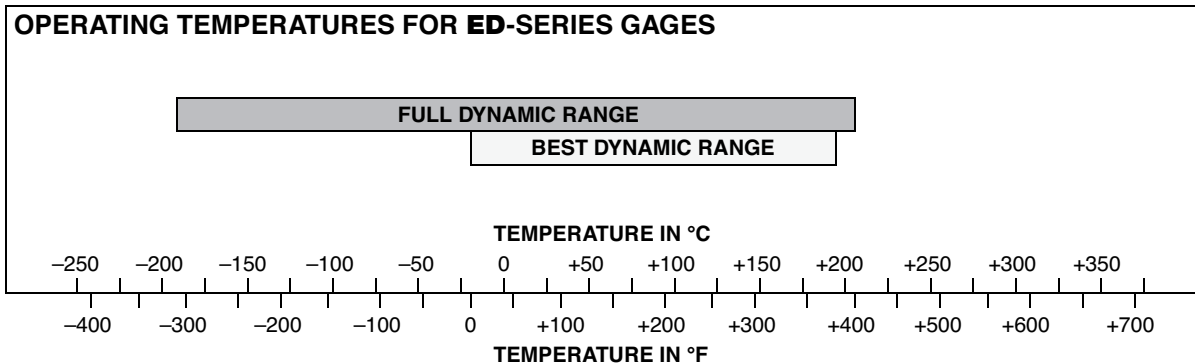

Technical Data

WD SERIES

WD-Series gages are fully encapsulated isoelastic alloy with integral, high-endurance beryllium copper leadwires. The matrix is a high-temperature epoxy-phenolic resin system reinforced with glass fibers. Overall gage thickness is approximately 0.0028 in (0.071 mm). These gages are excellent in dynamic strain measurement over wide temperature ranges. The WD Series is considerably less flexible than the ED type, but is useful over a wider temperature range and in more severe environments. The encapsulation matrix and integral high-endurance leadwires provide higher fatigue life than ED-Series gages. No standard options are available. Strain limits for WD-Series gages are approximately $\pm 5000\mu\epsilon$. Heat-curing adhesives such as M-Bond 600 or 610 will provide best overall performance.

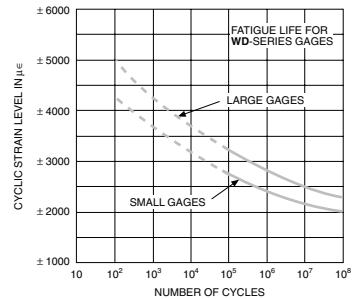

OPERATING TEMPERATURES FOR WD-SERIES GAGES

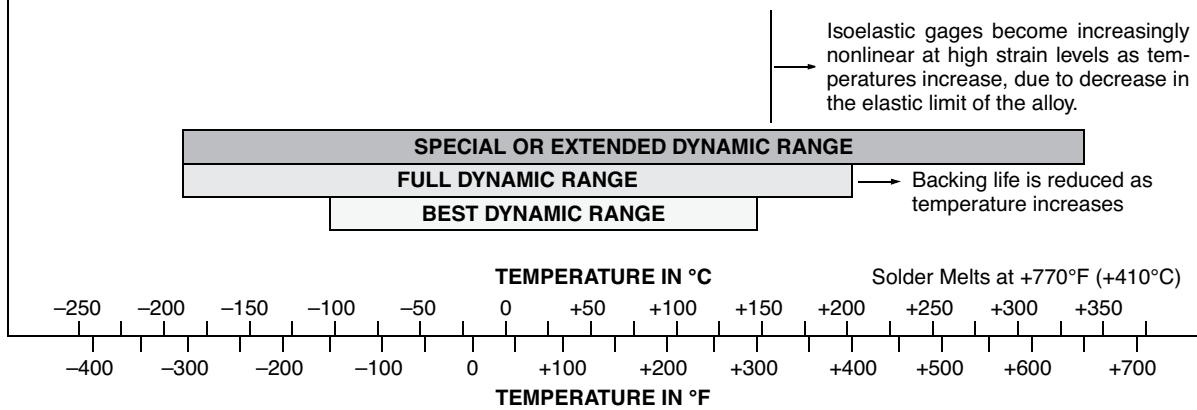

SD SERIES

SD-Series gages are fully encapsulated isoelastic alloy similar to WD-Series gages, but with solder dots instead of leadwires. The matrix is somewhat thinner than the WD type, with an overall thickness of approximately 0.002 in (0.05 mm). The solder is a lead-tin-silver alloy which melts at +570°F (+300°C). The SD Series is primarily used over the WD type when the matrix must be trimmed very close to the gage pattern because of restricted mounting space. There are no integral leadwires to restrict trimming of the lower edge of the matrix, and attachment wires can be routed to the solder dot tabs from any direction. Both maximum operating temperature and fatigue life are somewhat lower than in the WD Series because of the exposed solder dots. Strain limits are approximately $\pm 1\%$, but nonlinearity becomes increasingly severe above $\pm 5000\mu\epsilon$. Heat-curing adhesives such as M-Bond 600 or 610 will provide best overall performance.

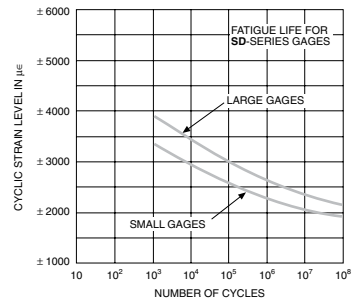

OPERATING TEMPERATURES FOR SD-SERIES GAGES

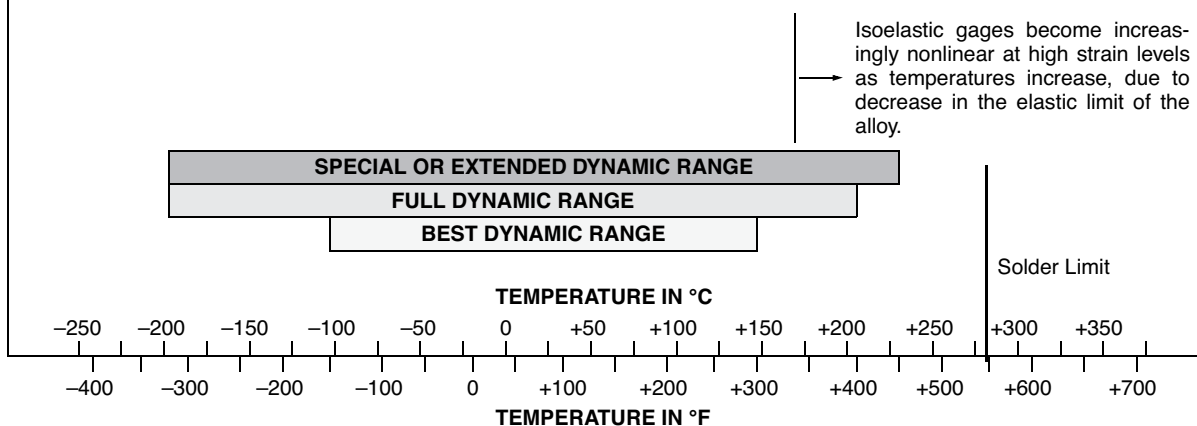

Technical Data

EK SERIES

EK-Series gages are K alloy, often employed in general-purpose testing where higher resistances and grid stability are required, particularly at elevated temperatures. They are normally selected for applications where reinforced laminate-backed gages lack sufficient flexibility. EK gages are of openfaced construction on a 0.001 in (0.025 mm) tough, flexible cast polyimide backing. The strong, heat-resistant backing provides excellent handling and performance qualities, and is treated for good bond formation with all standard strain gage adhesives. Heat-curing adhesives such as M-Bond 610 are recommended for full-temperature-range capabilities. Strain limits for this series are approximately $\pm 1.5\%$. EK gages are often selected instead of EA gages for improved fatigue life. However, when maximum fatigue life is required, reinforced laminate-backed K-alloy gages are recommended. Soldering to K-alloy is difficult, and duplex copper pads or dots are included as a standard feature. Most options available on EA-Series gages are offered with EK gages, but performance may be degraded.

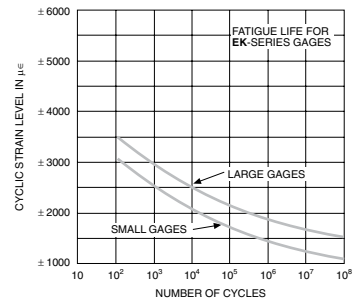

OPERATING TEMPERATURES FOR EK-SERIES GAGES

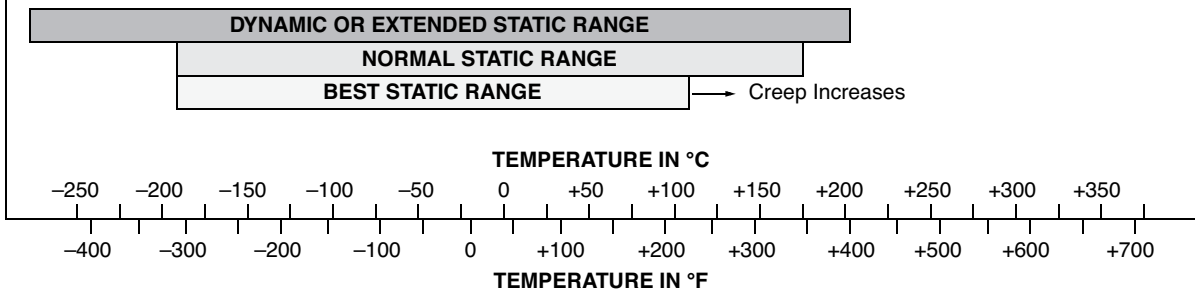

WK SERIES

WK-Series gages are fully encapsulated K alloy, equipped with integral, high-endurance beryllium copper leadwires. The matrix is a high-temperature epoxy-phenolic resin system reinforced with glass fibers. Overall gage thickness is approximately 0.0028 in (0.071 mm). WK-Series gages have the widest temperature range and most extensive environmental capability of any general purpose strain gage of the self-temperature-compensated type. Option W is available on many pattern designs, but will lower the excellent cyclic endurance and maximum operating temperature of the basic WK gage. Elevated temperature drift of these gages is very low to +600°F (+315°C), and the main restriction at high temperatures is the limited life of the backing and adhesive due to oxidation and sublimation. Strain limits for WK gages are approximately $\pm 1.5\%$. High temperature adhesives such as M-Bond 610 are required for full-range performance.

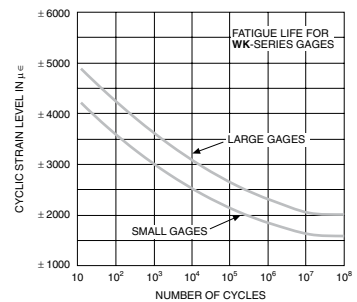

OPERATING TEMPERATURES FOR WK-SERIES GAGES

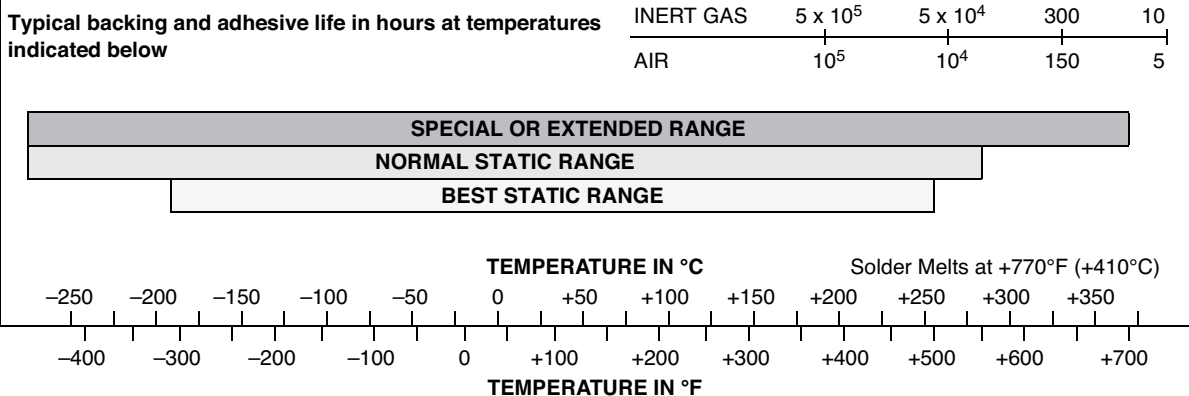

Technical Data

SK SERIES

SK-Series gages are fully encapsulated similar to the WK-Series gages, but with solder dots instead of leadwires. The matrix is somewhat thinner than the WK type, with an overall thickness of approximately 0.002 in (0.05 mm). The solder is a lead-tin-silver alloy which melts at approximately +570°F (+300°C). SK gages are primarily used when mounting space is restricted. Performance is equivalent to the WK type, but over a lower temperature range. Fatigue life of the SK Series is equivalent to the WK type, but more care is required during leadwire attachment to avoid gage damage. The absence of integral leadwires allows SK gages to be field-trimmed very close to the pattern size. No leadwire options are available. Strain limits are approximately ±1.5%. Heat-curing adhesives such as M-Bond 610 will provide best overall performance.

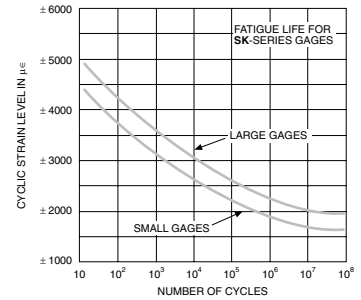

OPERATING TEMPERATURES FOR SK-SERIES GAGES

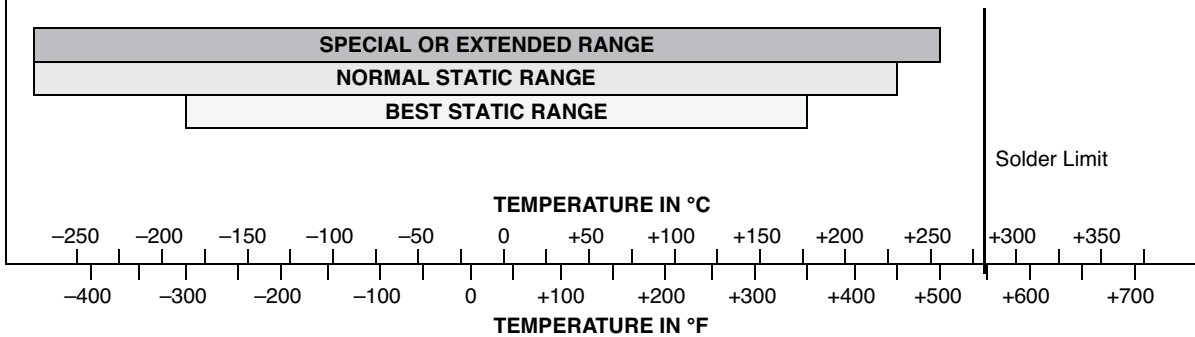

S2K SERIES

S2K-Series gages are fully encapsulated K alloy, equipped with large integral solder dots. The backing and encapsulation are 0.001 in (0.025 mm) thick laminated high-performance polyimide. The overlay fully encapsulates the grid and solder tabs. Large [0.030 in (0.75 mm)] diameter solder pads are provided for ease of leadwire attachment. Overall gage thickness is approximately 0.0025 in (0.065 mm) and the backing has been specially treated for optimum bond formation. M-Bond 43-B is recommended for S2K-Series gages if a cure temperature of +350°F (+175°C) is possible. Alternatively, M-Bond AE-10/15, M-Bond 200, or M-Bond 600/610 may be used. The S2K Series has an elongation capability exceeding ±1.5%. Designed primarily for use on composites, these gages are normally produced in larger patterns and higher resistances.

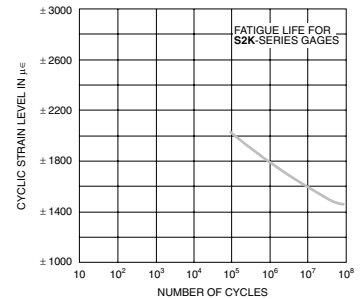

OPERATING TEMPERATURES FOR S2K-SERIES GAGES

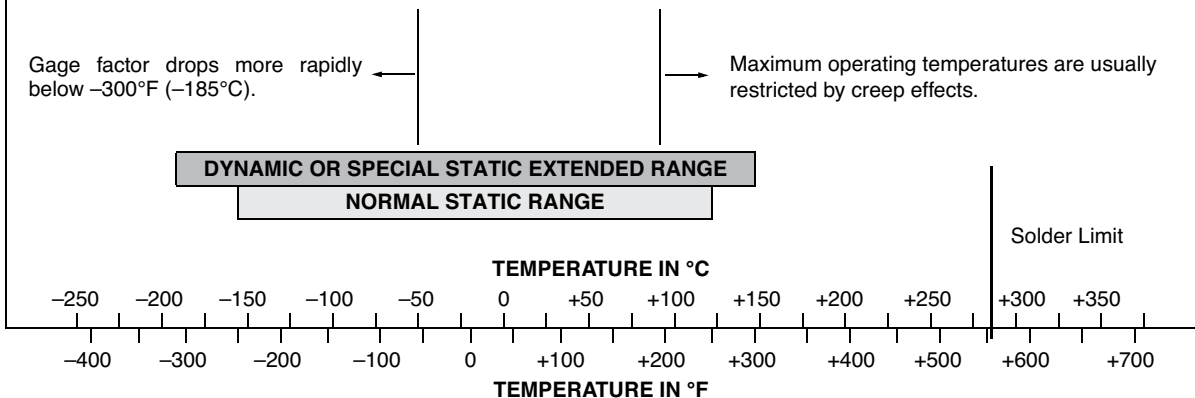

Technical Data

OPTIONAL FEATURES

Micro-Measurements offers a wide selection of optional features for its general-purpose strain gages and special-purpose sensors. The addition of options to the basic gage construction usually increases the cost, but this is generally offset by the benefits. Examples are:

- Significant reduction of installation time and costs.
- Reduction of the skill level necessary to make dependable installations.
- Increased reliability of applications.

- Simplified installation of sensors in difficult locations on components or in the field.
- Increased protection, both in handling during installation and shielding from the test environment.
- Achievement of special performance characteristics.

Availability of each option varies with gage series and pattern. Standard options are noted for each sensor in the product listing.

Shown below is a summary of the optional features offered. Detailed descriptions will be found on the following pages.

STANDARD OPTIONS

The optional features shown below are considered standard when they are listed with the gage series and pattern in the General-Purpose Strain Gage Listings.

OPTION	BRIEF DESCRIPTION	AVAILABLE ON GAGE SERIES
W	Integral Terminals and Encapsulation	As shown in General-Use Strain Gage Listings
E	Encapsulation with Exposed Tabs	
SE	Solder Dots and Encapsulation	
L	Preattached Leads	
LE	Preattached Leads and Encapsulation	
P	Preattached Leadwire Cables and Encapsulation	
P2	Preattached Leadwire Cables for CEA-Series Gages	Special order required
R	Individually Furnished Resistance Value	
S	Solder Dots	
W3	Special Terminals	

If the option desired is not shown in the Strain Gage Listings, it may be available as a special order. Please contact our Applications Engineering Department for specific information.

SPECIAL OPTIONS

The following applies to Special Options:

1. Availability will depend on the specific gage series and pattern.
2. A quotation is required and can be requested from our Customer Service Department.
3. A minimum order quantity may be required.
4. Whenever more than one Special Option is required, a custom part number will be assigned to the gage/option combination.

OPTION	BRIEF DESCRIPTION	AVAILABLE ON GAGE SERIES
SP-11-14	Single Batch of Foil per Order	All
SP21-24	'Modulus-Compensating' Foil	EK, WK, SK, S2K
SP30	Round Ni-Clad Copper Leads	EA, WA, ED, WD, EK, WK, EP
SP60	Special Encapsulation	Only on Manganin Gages
SP61	Preattached Leads and Encapsulation	N2A, N2P

Note 1: Products with designations and options shown in **bold** are not RoHS compliant.

Technical Data

STANDARD OPTIONS

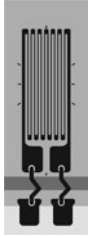
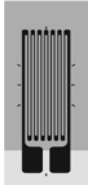
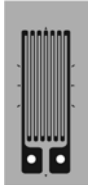
OPTION W	SERIES AVAILABILITY: EA, EP, WA, ED, WD, EK, WK	
<p>General Description: This option provides encapsulation, and thin, printed circuit terminals at the tab end of the gage. Beryllium copper jumpers connect the terminals to the gage tabs. The terminals are 0.0014 in (0.036 mm) thick copper on polyimide backing nominally 0.0015 in (0.038 mm) thick. Option W gages are rugged and well protected, and permit the direct attachment of larger leadwires than would be possible with open-faced gages. This option is primarily used on EA-Series gages for general-purpose applications. Solder: +430°F (+220°C) tin-silver alloy solder joints on E-backed gages, +570°F (+300°C) lead-tin-silver alloy solder joints on W-backed gages. Temperature Limit: +350°F (+175°C) for E-backed gages, +450°F (+230°C) for W-backed gages. Grid Protection: Entire grid and part of terminals are encapsulated with polyimide. Fatigue Life: Some loss in fatigue life unless strain levels at the terminal location are below $\pm 1000\mu\epsilon$. Size: Option W extends from the soldering tab end of the gages and thereby increases gage size. With some patterns, width is slightly greater. Strain Range: With some gage series, notably E-backed gages, strain range will be reduced. This effect is greatest with EP gages, and Option W should be avoided with them if possible. Flexibility: Option W adds encapsulation, making gages slightly thicker and stiffer. Conformance to curved surfaces will be somewhat reduced. In the terminal area itself, stiffness is markedly increased. Resistance Tolerance: On E-backed gages, resistance tolerance is normally doubled.</p>		
<p>OPTION E</p> <p>SERIES AVAILABILITY: EA, ED, EK, EP</p> <p>General Description: Option E consists of a protective encapsulation of polyimide film approximately 0.001 in (0.025 mm) thick. This provides ruggedness and excellent grid protection, with little sacrifice in flexibility. Soldering is greatly simplified since the solder is prevented from tinning any more of the gage tab than is deliberately exposed for lead attachment. Option E protects the grid from fingerprints and other contaminating agents during installation and, therefore, contributes significantly to long-term gage stability. Heavier leads may be attached directly to the gage tabs for simple static load tests. Supplementary protective coatings should still be applied after lead attachment in most cases. Temperature Limit: No degradation. Grid Protection: Entire grid and part of tabs are encapsulated. Fatigue Life: When gages are properly wired with small jumpers, maximum endurance is easily obtained. Size: Gage size is not affected. Strain Range: Strain range of gages will be reduced because the additional reinforcement of the polyimide encapsulation can cause bond failure before the gage reaches its full strain capability. Flexibility: Option E gages are almost as conformable on curved surfaces as open-faced gages, since no internal leads or solder are present at the time of installation. Resistance Tolerance: Resistance tolerance is normally doubled when Option E is selected.</p>		
<p>OPTION SE</p> <p>SERIES AVAILABILITY: EA, ED, EK, EP</p> <p>General Description: Option SE is the combination of solder dots on the gage tabs with a 0.001 in (0.025 mm) polyimide encapsulation layer that covers the entire gage. The encapsulation is removed over the solder dots providing access for lead attachment. These gages are very flexible, and well protected from handling damage during installation. Option SE is primarily intended for small gages that must be installed in restricted areas, since leadwires can be routed to the exposed solder dots from any direction. The option does not increase overall gage dimensions, so the matrix may be field-trimmed very close to the actual pattern size. Option SE is sometimes useful on miniature transducers of medium- or low-accuracy class, or in stress analysis work on miniature parts. Solder: +570°F (+300°C) lead-tin-silver alloy. To prevent loss of long-term stability, gages with Option SE must be soldered with noncorrosive (rosin) flux, and all flux residue should be carefully removed with M-LINE Rosin Solvent after wiring. Protective coatings should then be used. Temperature Limit: No degradation. Grid Protection: Entire gage is encapsulated. Fatigue Life: When gages are properly wired with small jumpers, maximum endurance is easily obtained. Size: Gage size is not affected. Strain Range: Strain range of gages will be reduced because the additional reinforcement of the polyimide encapsulation can cause bond failure before the gage reaches its full strain capability. Flexibility: Option SE gages are almost as conformable on curved surfaces as open-faced gages. Resistance Tolerance: Resistance tolerance is normally doubled when Option SE is selected.</p>		

Technical Data

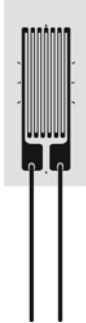
OPTION L	SERIES AVAILABILITY: EA, ED, EK, EP	
<p>General Description: Option L is the addition of soft copper lead ribbons to open-faced polyimide-backed gages. The use of this type of ribbon results in a thinner and more conformable gage than would be the case with round wires of equivalent cross section. At the same time, the ribbon is so designed that it forms almost as readily in any desired direction. Leads: Nominal ribbon size for most gages is 0.012 wide x 0.004 in thick (0.30 x 0.10 mm). Leads are approximately 0.8 in (20 mm) long. Solder: +430°F (+220°C) tin-silver alloy. Temperature Limit: +400°F (+200°C). Fatigue Life: Fatigue life will normally be degraded by Option L. This occurs primarily because the copper ribbon has limited cyclic endurance. When it is possible to carefully dress the leads so that they are not bonded in a high strain field, the performance limitation will not apply. Option L is not often recommended for very high endurance gages such as the ED Series. Size: Matrix size is unchanged. Strain Range: Strain range will usually be reduced by the addition of Option L. Flexibility: Gages with Option L are not as conformable as standard gages. Resistance Tolerance: Not affected.</p>		

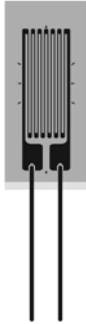
OPTION LE	SERIES AVAILABILITY: EA, ED, EK, EP	
<p>General Description: This option provides the same conformable soft copper lead ribbons as used in Option L, but with the addition of a 0.001 in (0.025 mm) thick encapsulation layer of polyimide film. The encapsulation layer provides excellent protection for the gage during handling and installation. It also contributes greatly to environmental protection, though supplementary coatings are still recommended for field use. Gages with Option LE will normally show better long-term stability than open-faced gages which are “waterproofed” only after installation. A good part of the reason for this is that the encapsulation layer prevents contamination of the grid surface from fingerprints or other agents during handling and installation. The presence of such contaminants will cause some loss in gage stability, even though the gage is subsequently coated with protective compounds. Leads: Nominal ribbon size for most gages is 0.012 wide x 0.004 in thick (0.30 x 0.10 mm) copper ribbons. Leads are approximately 0.8 in (20 mm) long. Solder: +430°F (+220°C) tin-silver alloy. Temperature Limit: +400°F (+200°C). Grid Protection: Entire gage is encapsulated. A short extension of the backing is left uncovered at the leadwire end to prevent contact between the leadwires and the specimen surface. Fatigue Life: Fatigue life will normally be degraded by Option LE. This occurs primarily because the copper ribbon has limited cyclic endurance. Option LE is not often recommended for very high endurance gages such as the ED Series. Size: Matrix size is unchanged. Strain Range: Strain range will usually be reduced by the addition of Option LE. Flexibility: Gages with Option LE are not as conformable as standard gages. Resistance Tolerance: Resistance tolerance is normally doubled by the addition of Option LE.</p>		

LEADWIRE ORIENTATION FOR OPTIONS L AND LE

These illustrations show the standard orientation of leadwires relative to the gage pattern geometry for Options L and LE. The general rule is that the leads are parallel to the longest dimension of the pattern. The illustrations also apply to leadwire orientation for WA-, WK- and WD-Series gages, when the pattern shown is available in one of these series.

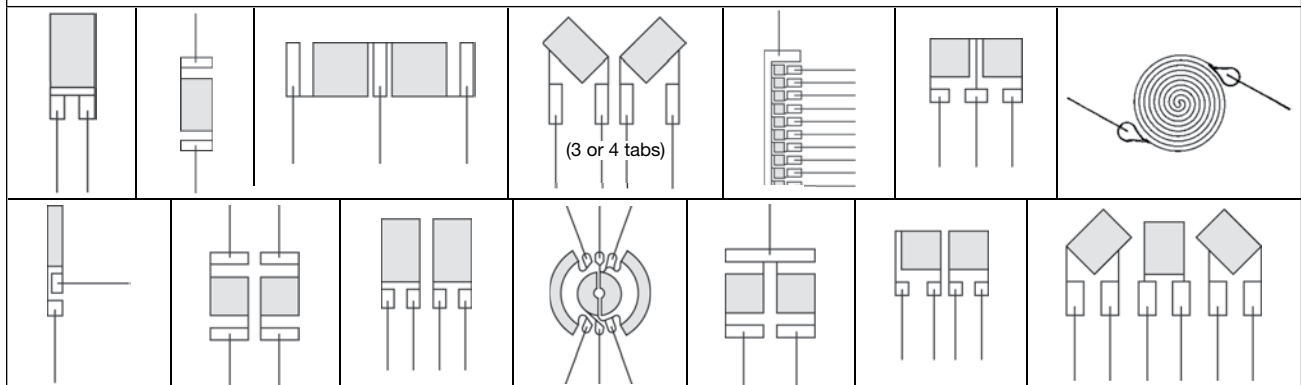

Technical Data

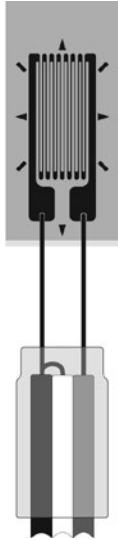
OPTION P	SERIES AVAILABILITY: EA, N2A	
<p>General Description: Option P is the addition of preattached leadwire cables to many patterns of EA Series strain gages. Encapsulation seals small “jumper” leadwires at gage end, and cable insulation protects solder joints at cable end. Option P virtually eliminates need for soldering during gage installation. Leads: A pair of 1 in (25 mm) <i>M-LINE</i> 134-AWP (solid copper, polyurethane enamel) single conductor “jumper” leadwires. Cable: 10 ft (3.1 m) of color-coded, flat, three-conductor 26-gauge (0.404 mm dia.), stranded, tinned copper with vinyl insulation (similar to <i>M-LINE</i> 326-DFV). Solder: +430°F (+220°C) tin-silver alloy solder joints, “jumper” to gage. Cable conductors and “jumpers” joined with +361°F solder beneath cable insulation. Exposed leadwires on unattached end of cable are pretinned for ease of hookup. Temperature Limit: –60° to +180°F (–50° to +80°C); limited by vinyl insulation on cable. Grid Encapsulation: Entire grid and tabs are encapsulated. Fatigue Life: Fatigue life will normally be degraded by Option P, primarily because the copper “jumper” wires have limited cyclic endurance. Pattern Availability: Most EA-Series single-grid patterns that are 0.062 in (1.5 mm) or greater gage length, with parallel solder tabs on one end of the grid, and suitable for encapsulation. (Consult our Applications Engineering Department for availability of Option P on other gage series/patterns, and for nonstandard cable lengths.) Size: Matrix size is unchanged. Strain Range: Strain range will usually be reduced by the addition of Option P. Flexibility: E-backed gages with Option P are not as conformable as standard gages. Resistance Considerations: Each conductor of the cable has a nominal resistance of 0.04 ohm/ft (0.13 ohm/m). Gage resistance is measured at gage tabs. Gage Factor: Gage factor is determined for gages without preattached cable. Resistance Tolerance: Resistance tolerance is normally ±0.5% for single-element gages, and ±0.6% for multiple-grid gages.</p>		

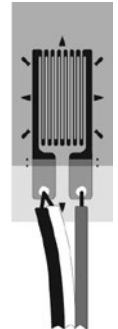
OPTION P2	SERIES AVAILABILITY: CEA	
<p>General Description: Option P2 is the addition of preattached leadwire cables to CEA-Series strain gages. Option P2 virtually eliminates need for soldering during gage installation. Cable: 10 ft (3.1 m) of color-coded, flat, three-conductor 30-gauge (0.255 mm), stranded, tinned copper with vinyl insulation (similar to <i>M-LINE</i> 330-DFV). Solder: +361°F (+180°C) tin-lead alloy solder joints. Exposed leadwires on unattached end of cable are pretinned for ease of hookup. Temperature Limit: –60° to +180°F (–50° to +80°C); limited by vinyl insulation on cable. Grid Encapsulation: Entire grid is encapsulated. (Solder tabs are not encapsulated.) Fatigue Life: Fatigue life will normally be unchanged by Option P2. Pattern Availability: Most CEA-Series single- and multiple-grid patterns. Size: Matrix size is unchanged. Strain Range: Standard for CEA-Series gages. Flexibility: No appreciable increase in stiffness. Resistance Considerations: Each conductor of the cable has a nominal resistance of 0.1 ohm/ft (0.35 ohm/m). Gage resistance is measured at gage tabs. Gage Factor: Gage factor is determined for gages without preattached cable. Resistance Tolerance: Not affected.</p>		

OPTION S	SERIES AVAILABILITY: EA, ED, EP	
<p>Precisely formed hemispherical solder dots are installed in the center of each solder tab. This feature facilitates soldering by providing a pretinned area for lead attachment. A film of adhesive or appropriate protective coating is normally applied over the gage before soldering, and this prevents the solder from spreading on the tab when leads are reinstalled. After the top coating has been cured, the solder dot is easily exposed for soldering by scraping with a scalpel or by simply post-tinning. Solder used for the dots is +570°F (+300°C) lead-tin-silver alloy. Dot diameter varies somewhat with tab size but is usually about 0.02 in (0.5 mm). Temperature limit for this feature is +500°F (+260°C). Because the solder dots result in much greater soldering uniformity, the variable fatigue life factor, which results from excessive solder on the gage tabs, is eliminated. Solder dots are small and interfere very little with flexibility and conformability of strain gages.</p>		

OPTION W3	SERIES AVAILABILITY: EA, EP, WA, ED, EK, WK	
<p>This feature is identical to Standard Catalog Option W, except that the printed circuit wiring terminals have three solder pads, two of which are electrically common. These terminals facilitate the connection of three-conductor cable for single active gage circuits using the three-wire lead system. Many of the gage patterns which are marked as available with Option W in the General-Purpose Strain Gage Listings are available with three-pad terminals.</p>		

Technical Data

OPTION R	SERIES AVAILABILITY: ALL
<p>The resistance of each gage is separately measured with an accurate digital ohmmeter and the exact value is recorded on the transparent folder that contains the gage. Resistance is given to the nearest 0.01 ohm, and the overall absolute accuracy is $\pm 0.05\%$ or better for gages of 60-ohm or greater resistance; thus allowing the user to select gages very closely matched in resistance from the total group of gages purchased. The necessary order quantity can be estimated for any matching requirements by assuming an even distribution of resistance values through the tolerance band, which is unchanged. Note: This feature is less effective for open-faced gages without leadwires or solder dots because of the uncertainty in leadwire position on the tabs with user-installed leadwires.</p>	

SPECIAL OPTIONS

OPTIONS SP11, 12, 13, 14	SERIES AVAILABILITY: ALL
<p>These options specify that all sensors are supplied from a single process batch and lot of foil. They are primarily used to obtain the closest possible matching of performance characteristics from a large group of gages.</p> <p style="margin-left: 40px;">SP11: One sensor type from a single batch of processed foil SP12: Two sensor types from a single batch of processed foil SP13: Three sensor types from a single batch of processed foil SP14: Four sensor types from a single batch of processed foil</p>	

OPTIONS SP21, 22, 23, 24	SERIES AVAILABILITY: EK, WK, SK, S2K			
<p>This option series provides strain gages with 'Modulus Compensation' features through use of specially modified lots of K alloy. The 'Mod-Comp' match will be quite close for the materials specified, although thermal output characteristics may not be ideal.</p>				
<p>When force-responsive type transducers are manufactured from the metals listed, and the appropriate Special Option gages are used, the result is a transducer which demonstrates very little span change with temperature.</p>	NOMINAL GAGE FACTOR SLOPE			
	Option	%/100°F	%/100°C	For Use On
	SP21	-1.50	-2.70	Stainless Steels
	SP22	-2.35	-4.25	Aluminum
	SP23	-1.25	-2.25	Tool Steels
SP24	-1.35	-2.45	Tool Steels	

OPTION SP30	SERIES AVAILABILITY: EA, WA, ED, WD, EK, WK, EP			
<p>General Description: This option consists of special leadwires, either added to open-faced gages, or substituted for lead ribbons on WA-, WK-, or WD-Series gages. The wire is very formable, and may be spot-welded or soldered to main leadwires. The primary advantages are easy handling and excellent resistance to oxidation at the highest temperatures the gages can withstand. Leads: 0.8 in (20 mm) long nickel-clad copper wires 0.005 in (0.13 mm) diameter. For some gage types, usually small patterns, wire size must be reduced to 0.0035 in (0.09 mm) diameter. Solder: EA-, ED-, EK-, EP-Series gages: +430°F (+220°C) tin-silver alloy; WA-Series gages: +570°F (+300°C) lead-tin-silver alloy; WK- and WD-Series gages: +770°F (+410°C) solder. Temperature Limit: E-backed gages: +400°F (+200°C); WA-Series gages: +500°F (+260°C); WK and WD-Series gages: +750°F (+400°C). Fatigue Life: Fatigue life will normally be degraded by Option SP30. This occurs primarily because the copper wire has limited cyclic endurance. Option SP30 should therefore not be used when best fatigue life is required, unless the tab area of the gage is in a low strain area ($\pm 1000\mu\epsilon$ or less). Loss of cyclic endurance is experienced particularly with WA-, WK-, and WD-Series gages. Size: Matrix size is unchanged. On W-backed gages, SP30 leads are substituted for the normal beryllium copper ribbon leads. One wire lead per tab is supplied. Strain Range: Option SP30 normally reduces the strain range of E-backed gages but does not similarly affect W-backed gages. Flexibility: E-backed gages with SP30 leads are not as conformable as standard gages. W-backed gages are not affected. Resistance Tolerance: Not affected.</p>				

Technical Data

OPTION SP60	SERIES AVAILABILITY: ONLY ON MANGANIN GAGES
<p>SP60 is an encapsulation option available for L-backed manganin gages. The end of each tab includes a thin copper coating that is left exposed for lead attachment.</p>	

OPTION SP61	SERIES AVAILABILITY: N2A, N2P
<p>General Description: This option provides conformable, soft copper lead ribbons and a 0.0005 in (0.013 mm) thick encapsulation layer of polyimide film. The encapsulation layer provides excellent protection for the gage during handling and installation. It also contributes greatly to environmental protection, though supplementary coatings are still recommended for field use. Gages with Option SP61 will normally show better long-term stability than open-faced gages which are “waterproofed” only after installation. A good part of the reason for this is that the encapsulation layer prevents contamination of the grid surface from fingerprints or other agents during handling and installation. The presence of such contaminants will cause some loss in gage stability, even though the gage is subsequently coated with protective compounds. Leads: 0.010 wide x 0.002 in thick (0.25 x 0.05 mm) soft copper ribbons. Leads are approximately 0.8 in (20 mm) long. Solder: +430°F (+220°C) tin-silver alloy. The solder is confined to small, well-defined areas at the end of each ribbon. Temperature Limit: +400°F (+200°C). Grid Protection: Entire gage is encapsulated. A short extension of the backing is left uncovered at the leadwire end to prevent contact between the leadwires and the specimen surface. Size: Matrix size is unchanged. Strain Range: Strain range will usually be reduced by the addition of Option SP61. Flexibility: Gages with Option SP61 are not as conformable as standard gages. Resistance Tolerance: Resistance tolerance is normally doubled by the addition of Option SP61.</p>	



Contact

mm@vpgsensors.com

micro-measurements.com