



● Oversea branches ● Distributors

# VIBRATION & SHOCK TEST SOLUTIONS



DONGLING Technologies  
 Add: No.2 Longshan Road, Science & Technology Town, Suzhou National  
 New & Hi-Tech Industrial Development Zone, Suzhou, Jiangsu Province, P.R.C  
 Zip Code: 215163  
 Tel: +86-512-6665 2225  
 Fax: +86-512-6665 5669  
 Email: info@donglingtech.com

DONGLING EUROPE OFFICE  
 Add: Via Edison 22/24, Strada Provinciale 30, Gudo Visconti, MI 20088, Italy  
 Tel: +39(0)2 9440252  
 Fax: +39(0)2 871 62890  
 Email: europe@donglingtech.com

DONGLING Technologies USA  
 Add: 7355 Clyde Park Avenue S.W., 8H, Byron Center, MI 49315 United States  
 Tel: +1 616 583-8246  
 Email: equipmentsales@donglingusa.com

[www.donglingtech.com](http://www.donglingtech.com)



201704

[www.donglingtech.com](http://www.donglingtech.com)



# Company Profile

Since 1995, DONGLING's growth and development has attracted the attention of the testing industry worldwide. DONGLING has come to the forefront with its global research and development, technology and production of test equipment and has shown its strength in numerous international projects.

DONGLING has accomplished considerable advancements in reliability and environmental test equipment as well as fatigue and strength test equipment. Our more than 300 products incorporate the latest technologies and satisfy the highest international standards. DONGLING'S products and services are widely used in automotive, aerospace, rail transit, aviation, ship building, defense and the electronics industries. DONGLING is a leading supplier of test equipment and integrated solutions in more than 50 countries.



www.donglingtech.com



## System Model

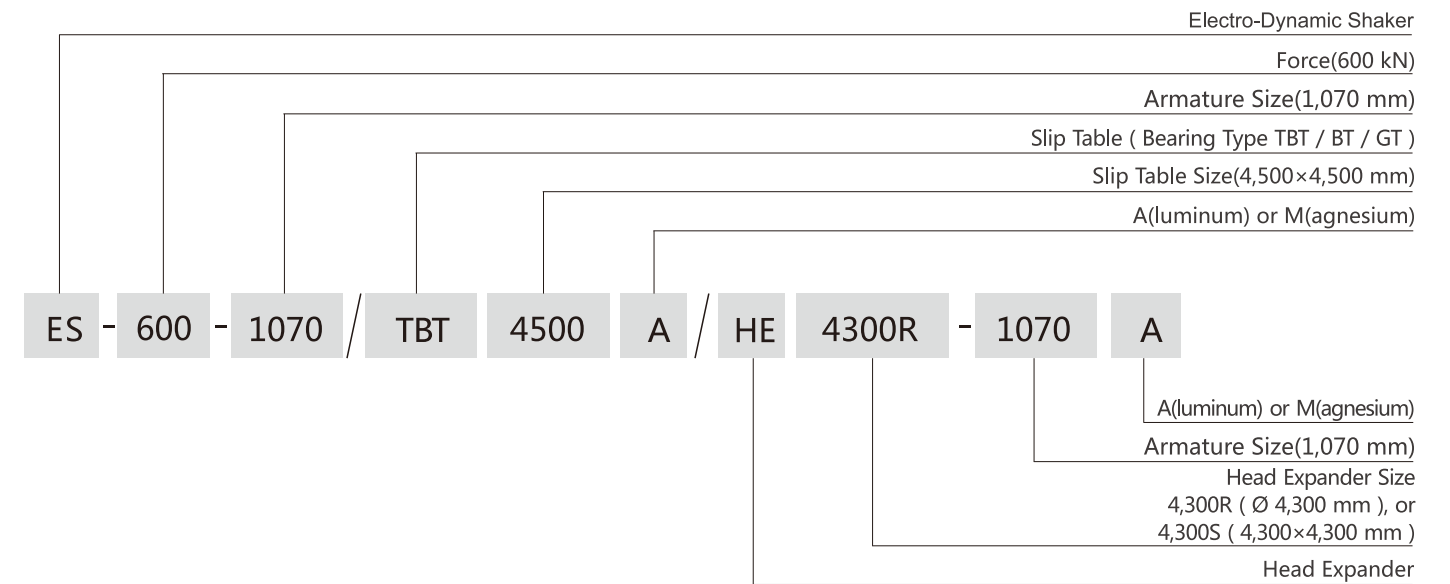

## How to Size Your Electro-dynamic Shaker

Calculate the force requirement for the required vibration test using the following formula:

$$F = (m_0 + m_1 + m_2 \dots + m_x) \times a$$

F = Force (N)

$m_0$  = Mass of Armature

$m_1$  = Mass of Fixture and Head Expander/ Slip Table

$m_2$  = Mass of Specimen

$m_x$  = Mass of Bolts, Thermal Barrier, etc.

a = Acceleration

### Example Calculation:

Mass of Armature  $m_0$  = 30kg

Mass of Fixture and Head Expander/ Slip Table  $m_1$  = 45kg

Mass of Specimen  $m_2$  = 35kg

Maximum Acceleration a = 196m/s<sup>2</sup>

The required force would be calculated as:

$$F = (30\text{kg} + 45\text{kg} + 35\text{kg}) \times 196.0\text{m/s}^2 = 21,560\text{N}$$

This calculation determines the minimum force required. In actual testing the required force would be 1.2 -1.3 times the minimum calculation depending on the actual test specifications. Therefore the actual minimum requirement would be calculated as 21,650 x 1.3 = 28,028N.

Refer to the shaker specifications to determine the shaker that can produce the required force that exceeds the minimum required in the above calculation which is 28,028N.

The ES-30-370 is the smallest shaker that can produce at least 28,028N. The ES-30-370 has a Sine force rating of 30kN. Remember, it is very important to consider both your current and your future needs when sizing your shaker.

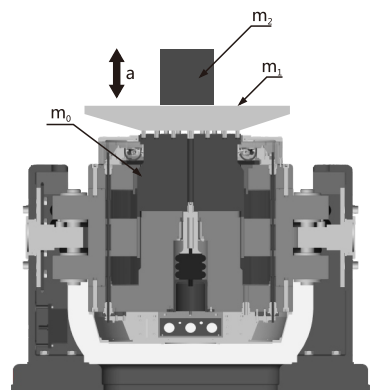

# Tri-axis Electro-dynamic Vibration Test System

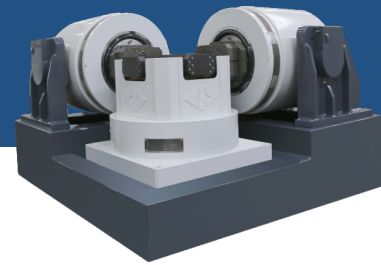

## Description

The DONGLING range of vibration test equipment includes the most advanced 3 axis electro-dynamic test system in the industry. This shaker system can more realistically simulate the dynamic environment of the real world by simultaneously exciting 3 different axis'. Additional benefits of simultaneous 3 axis testing are shortened test time, improvements in complex test analysis and a reduction in under and over testing that occurs when an article is only tested in a single axis. The 3 axis test system utilizes an advance hydraulic bearing to interconnect the 3 individual shakers and limits test article movement to the X, Y and Z axis'.

## Main Features

- Reduce test time – 3 axis testing can reduce test time versus performing 3 tests in a single axis.

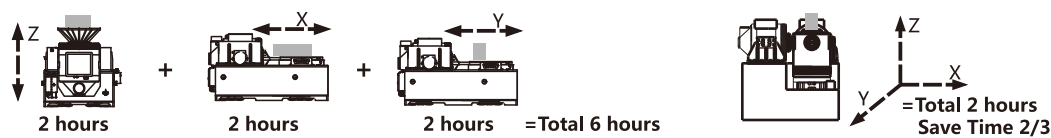

- More closely reproduce real world environment. More realistic than single axis shaker testing.
- Interlock Protection – Safe design that will shut down all shakers in the event there is an abort or malfunction triggered on any single shaker to protect the test specimen and the shaker system.
- High frequency range – The functional frequency range is up to 2000Hz or more to offer more choices to test engineers.

- **Orthogonal Coupling Bearing Unit(OCBU)**

- High Pressure loading of hydrostatic bearing, no metal contact.
- Provides pre-tightening stiffness
- Optimized coupling structure using FEA to ensure low mode.
- Foundry integrated supporting round shape.
- Advanced throttle hole distribution to ensure transmission of force. Oil film surface provides stiffness and durability.

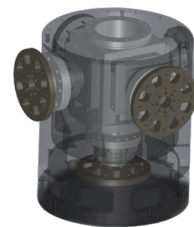

## Technical Parameters

Max. Frequency(Hz)	Sine	1,000
	Random	2,000
Max. Acceleration(m/s <sup>2</sup> )		120
Max. Velocity(m/s)		1.6
Max. Displacement(mm)		51

The 3 axis system is customized based on customer test requirements. Contact our sales people and provide below parameters to get your customized 3 axis system:

- Specimen Dimension
- Test Type
- Max. Velocity
- Specimen Mass
- Max. Acceleration
- Max. Displacement

## Working Principle

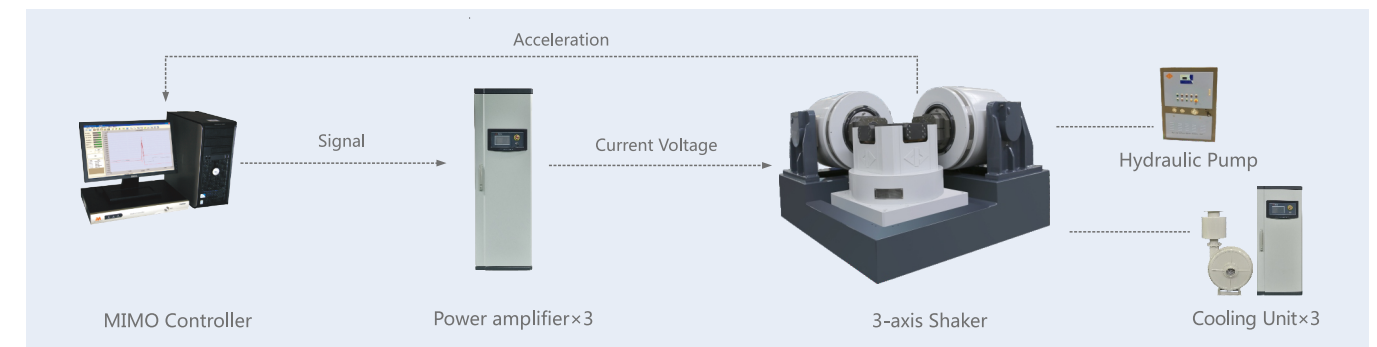

## Performance curve

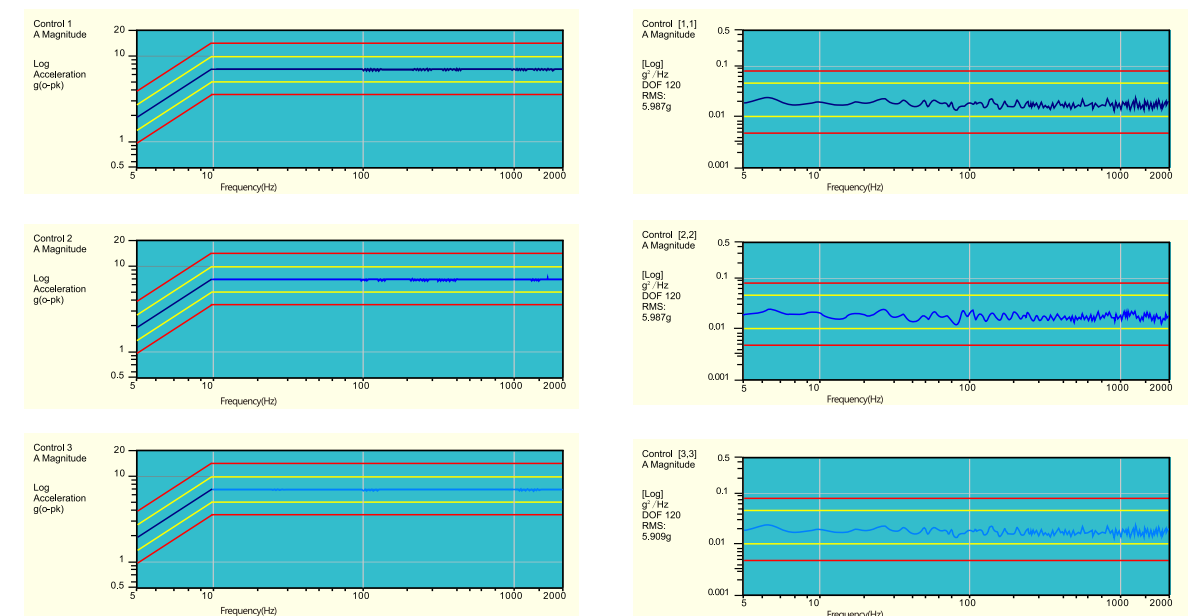



# Electro-dynamic Vibration Test System

## Air-cooled Series

Dongling is one of the largest and most innovative manufacturers of Air Cooled Vibration Testing Systems. With random sine force ratings from 1kN to 70 kN and maximum payloads from 70kg to as much as 1,000kg. Typical applications of Dongling's air-cooled electro-dynamic shakers include automotive component testing, electronics product testing, avionics testing and medical research, etc.

All air-cooled electro-dynamic shakers can be mounted on a single integrated base with a slip table to meet your testing requirements. DONGLING also provides turn-key solutions including combined environmental chambers, head expanders and fixtures should you require them.

System model	ES-1-150	ES-1.5-150	ES-2-150	ES-2-230	ES-3-150*	ES-3-230	ES-6-230*	ES-10-240*	ES-10D-240*
Sine(peak)/Random(rms)(kN)	1	1.5	2	2	3	3	6	10	10
Shock force(kN)	2	3	4	4	6	6	12	20	20
Frequency range(Hz)	5-4,500	5-4,500	5-4,000	5-2,500	5-4,000	5-2,500	5-3,500	5-3,000	5-5,000
Max.acceleration(m/s <sup>2</sup> )	500	750	1,000	250	1,000	350	1,000	1,000	1,000
Max.velocity(m/s)	2	2	2	1.5	2	1.5	1.8	1.8	1.8
Max.displacement(mm)	25	25	25	40	25	40	51	51	51
Max.load(kg)	70	70	70	140	120	140	300	300	300
<b>Shaker model</b>	ET-1-150	ET-1.5-150	ET-2-150	ET-2-230	ET-3-150	ET-3-230	ET-6-230	ET-10-240	ET-10D-240
Mass of moving elements(kg)	2	2	2	8	3	8.5	6	10	10
Armature diameter(mm)	150	150	150	230	150	230	230	240	240
Weight(kg)	About 395	About 395	About 395	About 430	About 480	About 430	About 590	About 900	About 900
Body suspension natural frequency(Hz)	3	3	3	3	3	3	3	2.5	2.5
Dimension(L×W×H: mm)	696×618×653			756×618×700	756×618×660.5	756×618×700	826×618×720	930×688×787	980×688×813
<b>Power amplifier model</b>	SDA-1	SDA-1.5	SDA-2	SDA-2	SDA-3	SDA-3	SDA-6	SDA-10	SDA-10
Power(kVA)	1	1.5	2	2	3	3	6	10	10
Power requirement(kVA)	4	4.5	5.5	5.5	6.5	6.5	16	21	21
Weight(kg)	About 160	About 160	About 200	About 200	About 200	About 200	About 240	About 400	About 400
Dimension(L×W×H: mm)	607×820×1545								
<b>Cooling type</b>	Air cooled								
Blower model	B-200	B-200	B-200	B-200	B-200	B-200	B-1000	B-1000	B-1000
Power(kW)	0.75	0.75	0.75	0.75	0.75	0.75	4	4	4
Air flow(m <sup>3</sup> /s)	0.1	0.1	0.1	0.1	0.1	0.1	0.33	0.33	0.33
Air pressure(kPa)	1	1	1	1	1	1	3.5	3.5	3.5
Weight(kg)	30	30	30	30	30	30	115	115	115

**Note:**  
 1. Optional accessories · Slip table · Head expander · Movable device · Thermal barrier · Climate chamber · Fixture · Sensor · Vibration controller · Power amplifier remote control · OPCS(Optical position centering system) · MPCS (Magnetic and pneumatic centering system) · Auto rotation mechanism  
 2. # is Magnesium alloy armature  
 3. \* (3 times shock) is optional  
 4. MPCS is standard from 20kN, option for 10kN, not available below 6kN  
 5. Auto rotation mechanism is standard from 50kN, option for 20-40kN, not available below 20kN  
 6. Dimension of power amplifier exclude eyebolt  
 7. The shock force may be limited during high-speed shock test

## Performance Characteristics

- Sinusoidal excitation force range: 1kN ~ 70kN
- Random to sinusoidal excitation force ratio 1:1
- Two-times-sine shock force (Three times optional)
- Displacement peak-to-peak value of 25mm, 40mm, 51mm, 76mm or 100mm
- Lightweight armature with optimized design and good vibration-resistant performance with excellent vibration isolation with the air spring at the trunnion position
- High weight bearing capacity of center air spring support and good low-frequency performance
- Equipped with an automatic centering system, to ensure the armature is always in a balanced position during movement
- Double magnetic circuit design with low flux leakage and uniform magnetic field
- Sine, Random and Shock etc. test function capabilities
- Good cooling effect and low noise blower

System model	ES-20-320	ES-20-445	ES-20LS3-340	ES-30-370	ES-30-550	ES-30LS4-445	ES-40-370	ES-40-445	ES-40LS4-445
Sine(peak)/Random(rms)(kN)	20	20	20	30	30	30	40	40	40
Shock force(kN)	40/60*	40/60*	40/60*	60/90*	60/90*	60/90*	80/120*	80/120*	80/120*
Frequency range(Hz)	5-3,000	5-2,800	5-3,000	5-2,800	5-2,000	5-2,600	5-2,800	5-2,700	5-2,600
Max.acceleration(m/s <sup>2</sup> )	1,000	700	800	1,000	545	750	1,300	800	900
Max.velocity(m/s)	2	2	2	2	2	1.8	2	2	1.8
Max.displacement(mm)	51	51	76	51	51	100	51	51	100
Max.load(kg)	300	300	300	500	500	500	500	800	500
<b>Shaker model</b>	ET-20-320	ET-20-445	ET-20LS3-340	ET-30-370	ET-30-550	ET-30LS4-445	ET-40-370	ET-40-445	ET-40LS4-445
Mass of moving elements(kg)	20	28	25	30	55	40	31	50	45
Armature diameter(mm)	320	445	340	370	550	445	370	445	445
Weight(kg)	About 1,700	About 1,700	About 1,700	About 2,490	About 2,540	About 2,540	About 2,490	About 4,500	About 2,540
Body suspension natural frequency(Hz)	2.5	2.5	2.5	2.5	2.5	2.5	2.5	2.5	2.5
Dimension(L×W×H: mm)	1222×760×1052		1222×760×1067	1328×854×1140	1328×854×1158	1328×854×1213	1328×854×1140	1730×1139×1272	1328×854×1213
<b>Power amplifier model</b>	SDA-20	SDA-20	SDA-20	SDA-30	SDA-30	SDA-30	SDA-40	SDA-40	SDA-40
Power(kVA)	20	20	20	30	30	30	40	40	40
Power requirement(kVA)	44	44	44	54	54	54	73	73	73
Weight(kg)	About 450	About 450	About 450	About 500	About 500	About 500	About 550	About 550	About 550
Dimension(L×W×H: mm)	607×820×1545			620×1010×1950					
<b>Cooling type</b>	Air cooled								
Blower model	B-2000LN	B-2000LN	B-2000LN	B-3000	B-3000	B-3000	B-5000	B-5000	B-5000
Power(kW)	7.5	7.5	7.5	7.5	7.5	7.5	15	15	15
Air flow(m <sup>3</sup> /s)	0.71	0.71	0.71	0.46	0.46	0.46	1.1	1.1	1.1
Air pressure(kPa)	3.5	3.5	3.5	8.8	8.8	8.8	7.7	7.7	7.7
Weight(kg)	140	140	140	180	180	180	255	255	255





System model	ES-50-445	ES-50LS3-445	ES-50LS4-445	ES-60-445	ES-60LS3-445	ES-60LS4-445	ES-70LS3-480	ES-70LS3-550
Sine(peak)/Random(rms)(kN)	50	50	50	60	60	60	70	70
Shock force(kN)	100/150*	100/150*	100/150*	120/180*	120/180*	120/180*	140/210*	140/210*
Frequency range(Hz)	5-2,700	5-2,600	5-2,500	5-2,700	5-2,600	5-2,500	5-2,700	5-2,500
Max.acceleration(m/s <sup>2</sup> )	1,000	900	850	1,000	1,000	1,000	1,000	850
Max.velocity(m/s)	2	2	2	2	2	2	2/2.5*	2/2.5*
Max.displacement(mm)	51	76	100	51	76	100	76	76
Max.load(kg)	800	800	800	800	800	800	1,000	1,000
<b>Shaker model</b>	ET-50-445	ET-50LS3-445	ET-50LS4-445	ET-60-445	ET-60LS3-445	ET-60LS4-445	ET-70LS3-480	ET-70LS3-550
Mass of moving elements(kg)	50	55	59	60	55	60	70	82
Armature diameter(mm)	445	445	445	445	445	445	480	550
Weight(kg)	About 4,500	About 4,500	About 4,500	About 4,500	About 4,500	About 4,500	About 4,500	About 7,300
Body suspension natural frequency(Hz)	2.5	2.5	2.5	2.5	2.5	2.5	2.5	2.5
Dimension(L×W×H: mm)	1730×1139×1272	1730×1139×1293	1730×1139×1348	1730×1139×1272	1730×1139×1293	1730×1139×1348	1730×1139×1304	1820×1297×1518
<b>Power amplifier model</b>	SDA-50	SDA-50	SDA-50	SDA-60	SDA-60	SDA-60	SDA-70	SDA-70
Power(kVA)	50	50	50	60	60	60	70	70
Power requirement(kVA)	82	82	82	95	95	95	108	108
Weight(kg)	About 550	About 550	About 550	About 700	About 700	About 700	About 700	About 700
Dimension(L×W×H: mm)	620×1010×1950							
<b>Cooling type</b>	Air cooled							
Blower model	B-5000	B-5000	B-5000	B-7000	B-7000	B-7000	B-7000	B-7000
Power(kW)	15	15	15	22	22	22	30	22
Air flow(m <sup>3</sup> /s)	1.1	1.1	1.1	1.6	1.6	1.6	1.6	1.6
Air pressure(kPa)	7.7	7.7	7.7	7.5	7.5	7.5	7.5	7.5
Weight(kg)	255	255	255	340	340	340	340	340

## Water-cooled Series

Water-cooled electro-dynamic shaker vibration test systems feature large force, large bearing capacity and high cooling efficiency. The exciting force range is from 25 kN to 600 kN and the maximum load is from 300 kg to 15,000 kg. Water-cooled vibration test systems are used to test some of the most complex and demanding products in areas of aviation, aerospace, automotive, shipbuilding, defense, and electronics, etc.

Water-cooled systems are capable of performing a variety of vibration test protocols, including: tri-axial sinusoidal vibration test, broad-band random vibration test, as well as the classical (semi-sinusoidal, trapezoidal, and post-peak sawtooth) pulse and shock response spectrum tests. When configured with an optional climate chamber, our water-cooled vibration test systems can also perform multi-environment combined vibration tests.

System model	ES-25WLS3-340	ES-35WLS3-340	ES-50W-445	ES-50WLS3-445	ES-50WLS4-445	ES-60W-445	ES-60WLS3-445	ES-60WLS4-445	ES-70W-445	ES-70WLS3-445
Sine(peak)/Random(rms)(kN)	25	35	50	50	50	60	60	60	70	70
Shock force(kN)	50/75*	70/105*	100/150*	100/150*	100/150*	120/180*	120/180*	120/180*	140/210*	140/210*
Frequency range(Hz)	5-2,800	5-2,800	5-2,700	5-2,500	5-2,400	5-2,700	5-2,500	5-2,400	5-2,700	5-2,500
Max.acceleration(m/s <sup>2</sup> )	1,000	1,300	1,000	900	850	1,000	1,000	1,000	1,000	1,000
Max.velocity(m/s)	2	2	2	2	2	2	2	2	2	2
Max.displacement(mm)	76	76	51	76	100	51	76	100	51	76
Max.load(kg)	300	300	800	800	800	800	800	800	800	800
<b>Shaker model</b>	ET-25WLS3-340	ET-35WLS3-340	ET-50W-445	ET-50WLS3-445	ET-50WLS4-445	ET-60W-445	ET-60WLS3-445	ET-60WLS4-445	ET-70W-445	ET-70WLS3-445
Mass of moving elements(kg)	25	25	50	55	60	60	60	60	60	60
Armature diameter(mm)	340	340	445	445	445	445	445	445	445	445
Weight(kg)	About 1,700	About 1,700	About 4,500	About 4,500	About 4,500	About 4,500	About 4,500	About 4,500	About 4,500	About 4,500
Body suspension natural frequency(Hz)	2.5	2.5	2.5	2.5	2.5	2.5	2.5	2.5	2.5	2.5
Dimension(L×W×H: mm)	1240×715×1071		1730×1104×1296	1730×1104×1308	1730×1104×1334	1730×1104×1296	1730×1104×1308	1730×1104×1334	1730×1104×1296	1730×1104×1308
<b>Power amplifier model</b>	SDA-30W	SDA-40W	SDA-50W	SDA-50W	SDA-50W	SDA-60W	SDA-60W	SDA-60W	SDA-70W	SDA-70W
Power(kVA)	36	48	50	50	50	60	60	60	70	70
Power requirement(kVA)	62	73	90	90	90	100	100	100	110	110
Weight(kg)	About 500	About 550	About 1,000	About 1,000	About 1,000	About 1,000	About 1,000	About 1,000	About 1,000	About 1,000
Dimension(L×W×H: mm)	600×1010×2020			1200×1010×2020						
<b>Cooling type</b>	Water cooled									
Cooling unit model	CU-1	CU-1	CU-1	CU-1	CU-2	CU-1	CU-1	CU-2	CU-1	CU-1
Internal circle water flow (distilled water)(L/min)	40			80		40		80		40
Internal water pressure (distilled water)(Mpa)	1			1		1		1		1
External circle water flow (city water)(L/min)	100			160		100		160		100
External water pressure (city water)(Mpa)	0.25~0.4			0.25~0.4		0.25~0.4		0.25~0.4		0.25~0.4
Water pump power (internal/external)(kVA)	4/2.5			8/4		4/2.5		8/4		4/2.5
Distilled water requirement	Hardness 30ppm, PH7-8, conductivity 1μS/cm									
Weight(kg)	About 250	About 250	About 250	About 250	About 300	About 250	About 250	About 300	About 250	About 250
Dimension(L×W×H: mm)	607×1010×2020									

**Note:**  
 1. Optional accessories • Slip table • Head expander • Movable device • Thermal barrier • Climate chamber • Fixture • Sensor • Vibration controller • Power amplifier remote control • Outer circulation unit  
 2. \* (3 times shock) is optional  
 3. Dimension of power amplifier and cooling unit exclude eyebolt

**Performance Characteristics**

- Random to sinusoidal excitation force ratio: 1:1
- Displacement peak-to-peak: 51mm, 76mm or 100mm
- Better vibration isolation effect with the air spring at trunnion position
- High weight bearing capacity of center air spring support and good low-frequency performance
- Equipped with an automatic centering system, to ensure the armature is always in a balanced position during movement
- Double magnetic circuit design, with low flux leakage and uniform magnetic field
- Electric power rotating mechanism is configured for horizontal and vertical switching
- Two-times-sine shock force (Three times optional)
- Lightweight armature and large working table

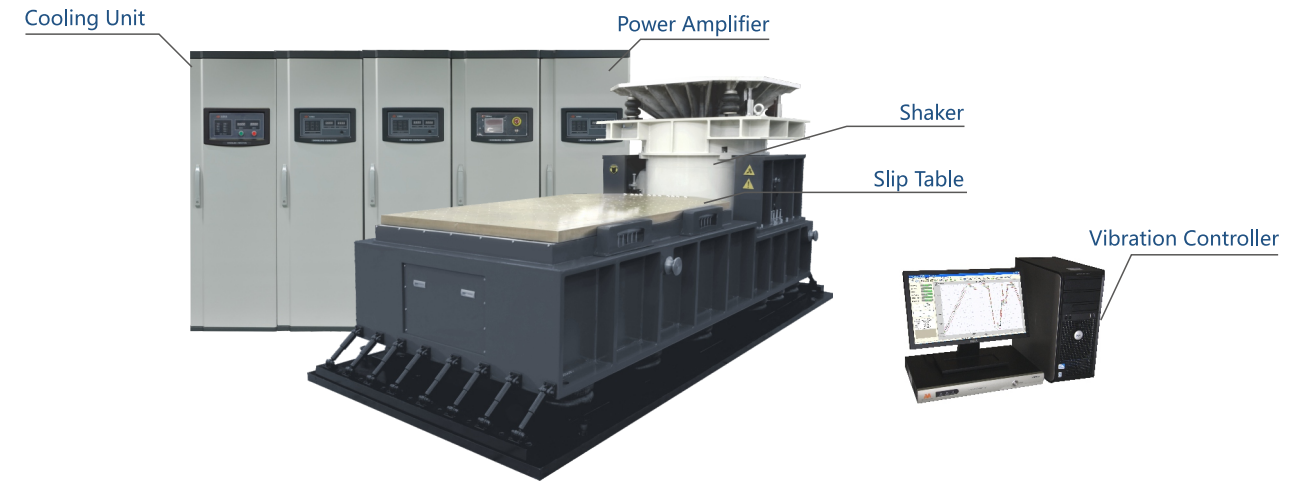

System model	ES-70WLS4-445	ES-80W-445	ES-80WLS3-445	ES-80WLS4-445	ES-100-550	ES-100LS3-550	ES-120-550	ES-120LS3-550	ES-160-590	
Sine(peak)/Random(rms)(kN)	70	80	80	80	100	100	120	120	160	
Shock force(kN)	140/210*	160/240*	160/240*	160/240*	200/300*	200/300*	240/360*	240/360*	320/480*	
Frequency range(Hz)	5-2,400	5-2,500	5-2,500	5-2,400	5-2,500	5-2,500	5-2,500	5-2,500	5-2,200	
Max.acceleration(m/s <sup>2</sup> )	1,000	1,000	1,000	1,000	1,000	1,000	1,000	1,000	1,000	
Max.velocity(m/s)	2	2	2	2	2	2	2	2	2	
Max.displacement(mm)	100	51	76	100	51	76	51	76	51	
Max.load(kg)	800	800	800	800	1,000	1,000	1,000	1,000	1,600	
<b>Shaker model</b>	ET-70WLS4-445	ET-80W-445	ET-80WLS3-445	ET-80WLS4-445	ET-100-550	ET-100LS3-550	ET-120-550	ET-120LS3-550	ET-160-590	
Mass of moving elements(kg)	60	60	60	60	90	90	90	90	140	
Armature diameter(mm)	445	445	445	445	550	550	550	550	590	
Weight(kg)	About 4,500	About 4,500	About 4,500	About 4,500	About 7,000	About 7,300	About 7,000	About 7,300	About 11,000	
Body suspension natural frequency(Hz)	2.5	2.5	2.5	2.5	2.5	2.5	2.5	2.5	2.5	
Dimension(L×W×H: mm)	1730×1104×1334	1730×1104×1308		1730×1104×1334	1780×1280×1380				2130×1480×1527	
<b>Power amplifier model</b>	SDA-80	SDA-80	SDA-80	SDA-80	SDA-100	SDA-100	SDA-120	SDA-120	SDA-160	
Power(kVA)	80	80	80	80	100	100	120	120	160	
Power requirement(kVA)	140	140	140	140	160	160	180	180	230	
Weight(kg)	About 1,800	About 1,800	About 1,800	About 1,800	About 1,900	About 1,900	About 1,900	About 1,900	About 2,600	
Dimension(L×W×H: mm)	1800×1010×2020									
<b>Cooling type</b>	Water cooled									
Cooling unit model	CU-2	CU-2	CU-2	CU-2	CU-2	CU-2	CU-2	CU-2	CU-2	
Internal circle water flow (distilled water)(L/min)	80									
Internal water pressure (distilled water)(Mpa)	1									
External circle water flow (city water)(L/min)	160									
External water pressure (city water)(Mpa)	0.25~0.4									
Water pump power (internal/external)(kW)	8/4									
Distilled water requirement	Hardness 30ppm, PH7-8, conductivity 1μS/cm									
Weight(kg)	About 300	About 300	About 300	About 300	About 300	About 300	About 300	About 300	About 300	
Dimension(L×W×H: mm)	607×1010×2020									

System model	ES-160-650	ES-180-590	ES-180-650	ES-200-650	ES-200LS3-650	ES-300-870	ES-350-870	ES-400-870	ES-500-1070	
Sine(peak)/Random(rms)(kN)	160	180	180	200	200	300/240	350/250	400/300	500/400	
Shock force(kN)	320/480*	360/480*	360/480*	400/500*	400/600*	600/900*	700/900*	800/1,000*	1,250	
Frequency range(Hz)	5-2,200	5-2,200	5-2,200	5-2,100	5-2,100	5-1,700	5-1,700	5-1,700	5-1,500	
Max.acceleration(m/s <sup>2</sup> )	1,000	1,000	1,000	1,000	1,000	1,000	1,000	1,000	1,000	
Max.velocity(m/s)	2	2	2	2	2	2	2	2	2	
Max.displacement(mm)	51	51	51	51	76	51	51	51/76*	60	
Max.load(kg)	1,800	1,600	1,800	2,500	2,500	6,000	6,000	6,000	15,000	
<b>Shaker model</b>	ET-160-650	ET-180-590	ET-180-650	ET-200-650	ET-200LS3-650	ET-300-870	ET-350-870	ET-400-870	ET-500-1070	
Mass of moving elements(kg)	150	140	150	150	150	300	300	330	500	
Armature diameter(mm)	650	590	650	650	650	870	870	870	1,070	
Weight(kg)	About 11,000	About 11,000	About 11,000	About 11,000	About 11,000	About 23,000	About 23,000	About 23,000	About 32,000	
Body suspension natural frequency(Hz)	2.5	2.5	2.5	2.5	2.5	2.5	2.5	2.5	3	
Dimension(L×W×H: mm)	2130×1480×1527			2130×1480×1553		2900×2066×1986			3500×2200×2250	
<b>Power amplifier model</b>	SDA-160	SDA-180	SDA-180	SDA-200	SDA-200	SDA-380	SDA-420	SDA-460	SDA-500	
Power(kVA)	160	180	180	200	200	380	420	410	550	
Power requirement(kVA)	230	250	250	280	280	390	440	490	600	
Weight(kg)	About 2,600	About 2,600	About 2,600	About 3,300	About 3,300	About 4,000	About 6,100	About 6,100	About 7,000	
Dimension(L×W×H: mm)	2400×1010×2020			3000×1010×2020		6000×1010×2020			7760×1010×2020	
<b>Cooling type</b>	Water cooled									
Cooling unit model	CU-2	CU-2	CU-2	CU-2	CU-2	CU-3	CU-3	CU-3	CU-4	
Internal circle water flow (distilled water)(L/min)	80					120			260	
Internal water pressure (distilled water)(Mpa)	1					1			1	
External circle water flow (city water)(L/min)	160					320			670	
External water pressure (city water)(Mpa)	0.25~0.4					0.25~0.4			0.25~0.4	
Water pump power (internal/external)(kW)	8/4					8/6.5			18/12	
Distilled water requirement	Hardness 30ppm, PH7-8, conductivity 1μS/cm									
Weight(kg)	About 300	About 300	About 300	About 300	About 300	About 300	About 300	About 300	About 450	
Dimension(L×W×H: mm)	607×1010×2020									



# Slip Table Series

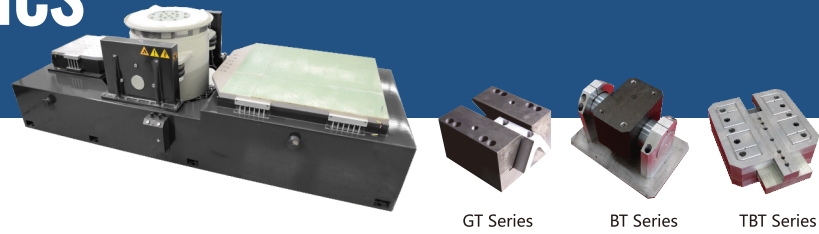

GT Series BT Series TBT Series

## V-shaped Bearing Slip Table

Shaker model	ES-1-150		ES-2-230		ES-6-230		ES-20-320		ES-20-445		ES-20LS3-340		ES-30-550		ES-30LS4-445		ES-50LS3/4-445		ES-70LS3-480		ES-70LS3-550			
	ES-1-150		ES-2-230		ES-6-230		ES-20-320		ES-20-445		ES-20LS3-340		ES-30-550		ES-30LS4-445		ES-50LS3/4-445		ES-70LS3-480		ES-70LS3-550			
Slip table model	ES-1-150		ES-2-230		ES-6-230		ES-20-320		ES-20-445		ES-20LS3-340		ES-30-550		ES-30LS4-445		ES-50LS3/4-445		ES-70LS3-480		ES-70LS3-550			
GT300	30	2,000	30	2,000	—		—		—		—		—		—		—		—		—			
GT400	30	2,000	30	2,000	30	2,000	—		—		—		—		—		—		—		—			
GT500	30	2,000	30	2,000	30	2,000	40	2,000	40	2,000	40	2,000	40	2,000	45	2,000	45	2,000	45	2,000	—		—	
GT600	40	2,000	40	2,000	40	2,000	40	2,000	40	2,000	40	2,000	40	2,000	45	2,000	45	2,000	45	2,000	—		—	
GT700	45	2,000	45	2,000	45	2,000	45	2,000	45	2,000	45	2,000	45	2,000	45	2,000	45	2,000	45	2,000	—		—	
GT800	—		—		45	2,000	45	2,000	45	2,000	45	2,000	45	2,000	45	2,000	45	2,000	45	2,000	50	2,000	—	
GT900	—		—		45	2,000	45	2,000	45	2,000	45	2,000	45	2,000	45	2,000	45	2,000	45	2,000	50	2,000	—	
GT1000	—		—		45	2,000	45	2,000	45	2,000	45	2,000	45	2,000	45	2,000	45	2,000	45	2,000	50	2,000	—	
GT1100	—		—		45	2,000	45	2,000	45	2,000	45	2,000	45	2,000	45	2,000	45	2,000	45	2,000	50	2,000	—	
GT1200	—		—		45	2,000	45	2,000	45	2,000	45	2,000	45	2,000	45	2,000	45	2,000	45	2,000	50	2,000	—	
GT1300	—		—		—		—		—		—		—		—		—		—		50	2,000		
GT1400	—		—		—		—		—		—		—		—		—		—		50	2,000		
GT1500	—		—		—		—		—		—		—		—		—		—		50	2,000		
GT2000	—		—		—		—		—		—		—		—		—		—		60	2,000		
Note	Thickness(mm)		Frequency(Hz)		Effective mass (Al) (kg)		Effective mass (Mg) (kg)		Effective mass (Al) (kg)		Effective mass (Mg) (kg)		Effective mass (Al) (kg)		Effective mass (Mg) (kg)		Effective mass (Al) (kg)		Effective mass (Mg) (kg)		Effective mass (Al) (kg)		Effective mass (Mg) (kg)	
	780		532		—		—		—		—		—		—		—		—		—		—	

- 1 GT300: 300mm×300mm
- 2 Effective mass includes slip plate, drive bar, swing pole, V-shaped bearing only
- 3 The above effective mass is under common design, if there are special requirement or special design, need to calculate the effective mass again
- 4 Working environment: Temperature range 5~35°C, humidity range ≤90% (non condensing)

# Slip Table Series

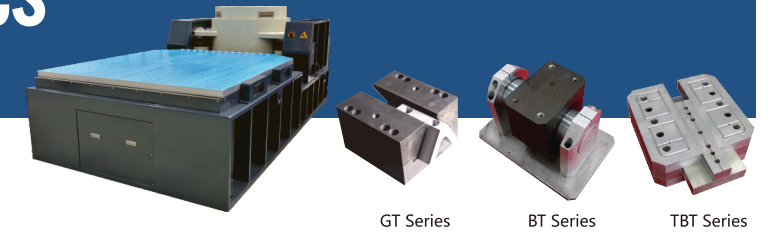

GT Series BT Series TBT Series

## 710 Hydrostatic Bearing / T-shaped Bearing Slip Table

Shaker model	ES-30-370		ES-40-445		ES-50LS3/4-445		ES-70LS3-480		ES-70LS3-550		ES-160-590		ES-160-650		ES-300-870		ES-500-1070			
	ES-30-370		ES-40-445		ES-50LS3/4-445		ES-70LS3-480		ES-70LS3-550		ES-160-590		ES-160-650		ES-300-870		ES-500-1070			
Slip table model-bearing No.	ES-30-370		ES-40-445		ES-50LS3/4-445		ES-70LS3-480		ES-70LS3-550		ES-160-590		ES-160-650		ES-300-870		ES-500-1070			
BT800-2/TBT800-4	50	2,000	50	2,000	50	2,000	50	2,000	50	2,000	50	2,000	50	2,000	50	2,000	50	2,000		
BT900-2/TBT900-4	50	2,000	50	2,000	50	2,000	50	2,000	50	2,000	50	2,000	50	2,000	50	2,000	50	2,000		
BT1000-4/TBT1000-4	50	2,000	50	2,000	50	2,000	50	2,000	50	2,000	50	2,000	50	2,000	50	2,000	50	2,000		
BT1100-4/TBT1100-9	50	2,000	50	2,000	50	2,000	50	2,000	50	2,000	50	2,000	50	2,000	50	2,000	50	2,000		
BT1200-4/TBT1200-9	50	2,000	50	2,000	50	2,000	50	2,000	50	2,000	50	2,000	50	2,000	50	2,000	50	2,000		
BT1300-4/TBT1300-9	50	2,000	50	2,000	50	2,000	50	2,000	50	2,000	50	2,000	50	2,000	50	2,000	50	2,000		
BT1400-4/TBT1400-16	50	1,600	50	1,600	50	1,600	50	1,600	50	1,600	50	1,600	50	1,600	50	1,600	50	1,600		
BT1500-4/TBT1500-16	50	1,200	50	1,200	50	1,200	50	1,200	50	1,200	50	1,200	50	1,200	50	1,200	50	1,200		
--/TBT2000-25	Thickness(mm)		Frequency(Hz)		Effective mass (Al) (kg)		Effective mass (Mg) (kg)		Effective mass (Al) (kg)		Effective mass (Mg) (kg)		Effective mass (Al) (kg)		Effective mass (Mg) (kg)		Effective mass (Al) (kg)		Effective mass (Mg) (kg)	
	778		530		800		552		800		552		800		552		800		552	
Note	<ul style="list-style-type: none"> <li>1 Effective mass includes slip plate, drive bar, swing pole, excluding mass of bearing (the effective mass of one BT hydrostatic bearing is 5kg, the effective mass of one TBT medium pressure bearing is 5.5kg)</li> <li>2 BT600 and BT700 are also available, contact our sales people if required</li> <li>3 Working environment: Temperature range 5~35°C, humidity range ≤90% (non condensing)</li> </ul>																			

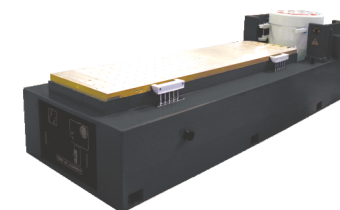

Slender slip table

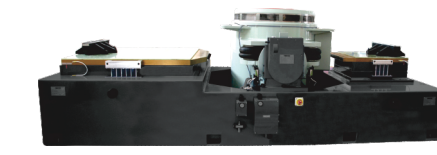

Dual slip table



Rotary slip table

# Head Expander Series

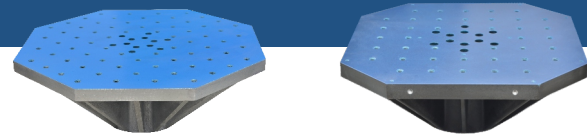

Square (aluminium alloy)

Square (magnesium alloy)

## Description

In most practical vibration test applications a head expander is required because the test specimen or the fixture is larger than the armature surface. In these cases a head expander is applied to provide a broader base for mounting the test specimen and fixtures. A head expander is made of lightweight magnesium or less expensive aluminum. Many types of standardized head expanders are available or special customization is also available to meet your requirements. Dongling head expanders are designed with load support which enables larger test specimens to be mounted and tested safely on the shaker and reduces the risk of damage to the shaker suspension system. Head expander design and customization are available for your existing vibration test system as well. Dongling provided head expanders have strict requirements related to frequency, table weight, acceleration, amplitude uniformity and lateral movement and are designed to meet your standards.

## Square Head Expander

Square Head Expander Specification																
Table diameter Model	-150		-230/-240		-320		-340/-370		-445/-480		-550		-590		-650	
	<b>HE300S</b>	7	2,000	10	2,000	—		—		—		—		Weight(Al)(kg)		Sine(Al)(Hz)
	5	2,000	7	1,800	—		—		—		—		Weight(Mg)(kg)		Sine(Mg)(Hz)	
<b>HE400S</b>	12	2,000	21	2,000	—		—		—		—		—		—	
	8.4	1,800	14.7	2,000	—		—		—		—		—		—	
<b>HE500S</b>	20	2,000	32	2,000	32	2,000	35	2,000	—		—		—		—	
	14	2,000	23	1,800	22.4	2,000	25	2,000	—		—		—		—	
<b>HE600S</b>	29	1,200	41	1,350	41	2,000	40	2,000	57	2,000	—		—		—	
	20.3	1,200	28	1,350	28	2,000	28	1,800	40	2,000	—		—		—	
<b>HE700S</b>	—		43	1,000	72	1,000	75	1,800	80	2,000	—		—		—	
	—		30.1	900	48	1,000	50	1,800	56	1,800	—		—		—	
<b>HE800S</b>	—		63	1,000	72	1,200	83	1,300	88	1,300	125	1,500	—		—	
	—		42	900	68	1,100	60	1,200	60	1,300	87.5	1,500	—		—	
<b>HE900S</b>	—		76	500	94	800	101	600	100	1,000	135	1,000	—		—	
	—		52.5	500	66	700	67	600	70	1,000	95	1,000	—		—	
<b>HE1000S</b>	—		80	400	117	550	120	800	185	1,000	225	900	220	1,000	210	1,200
	—		54.5	400	78	550	85	600	129.5	900	150	900	154	1,000	147	1,200
<b>HE1100S</b>	—		—		—		185	600	230	500	245	700	250	700	220	700
	—		—		—		126	600	161	500	171.5	700	175	700	154	700
<b>HE1200S</b>	—		176	500	—		191	400	250	500	275	500	280	500	286	450
	—		123	500	—		140	400	195	500	206	500	196	500	181	450
<b>HE1500S</b>	—		283	200	345	350	337	450	358	400	415	400	420	400	450	500
	—		198	200	230	350	225	450	245	400	292	400	294	400	315	500
<b>HE2000S</b>	Weight(Al)(kg)		Sine(Al)(Hz)		—		—		—		900	300	1000	300	910	300
	Weight(Mg)(kg)		Sine(Mg)(Hz)		—		—		—		630	300	700	300	610	300

# Head Expander Series

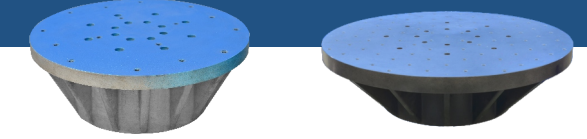

Round (aluminium alloy)

Round (magnesium alloy)

## Performance Characteristics

- All Dongling head expanders have passed finite element analysis
- Designed to optimize performance on your vibration test system
- High quality manufacturing process to ensure consistent performance with excellent technical indicators
- Options include “square” or “round” shape and “magnesium” or “aluminum” material
- Customized shapes and sizes are also available

## Round Head Expander

Round Head Expander Specification																
Table diameter Model	-150		-230/-240		-320		-340/-370		-445/-480		-550		-590		-650	
	<b>HE300R</b>	7	2,000	9	2,000	—		—		—		—		Weight(Al)(kg)		Sine(Al)(Hz)
	5	2,000	6	1,800	—		—		—		—		Weight(Mg)(kg)		Sine(Mg)(Hz)	
<b>HE400R</b>	10	2,000	14	2,000	16	2,000	—		—		—		—		—	
	7	2,000	10	2,000	11.2	2,000	—		—		—		—		—	
<b>HE500R</b>	20	2,000	23	2,000	32	2,000	32	2,000	—		—		—		—	
	14	2,000	16.1	2,000	22.4	2,000	22.4	2,000	—		—		—		—	
<b>HE600R</b>	—		31.5	1,200	33	1,800	39	1,600	38	2,000	—		—		—	
	—		22	1,200	23.1	1,800	27	1,600	26.6	1,900	—		—		—	
<b>HE700R</b>	—		33	800	58	1,500	69	2,000	70	2,000	—		—		—	
	—		23.1	800	41	1,500	48.3	2,000	49	2,000	—		—		—	
<b>HE800R</b>	—		37	500	64	800	70	1,200	72	1,500	85	1,800	—		—	
	—		26	500	45	800	49	1,200	50.4	1,500	59	1,800	—		—	
<b>HE900R</b>	—		—		—		85	1,200	100	1,200	—		—		—	
	—		—		—		59.5	1,200	70	1,200	—		—		—	
<b>HE1000R</b>	—		—		—		—		140	1,000	150	1,100	160	1,100	180	1,100
	—		—		—		—		98	1,000	105	1,100	112	1,100	126	1,100
<b>HE1100R</b>	—		—		—		—		200	800	210	900	230	1,000	260	1,000
	—		—		—		—		140	800	147	900	161	1,000	182	1,000
<b>HE1200R</b>	—		—		—		—		250	500	260	600	270	600	290	600
	—		—		—		—		175	500	182	600	189	600	203	600
<b>HE1500R</b>	Weight(Al)(kg)		Sine(Al)(Hz)		—		—		330	400	350	400	400	400	475	400
	Weight(Mg)(kg)		Sine(Mg)(Hz)		—		—		231	400	245	400	280	400	333	400

Note: 1. HE300S means it is square head expander, the effective size of the head expander is 300×300mm  
 HE600R means it is round head expander, the diameter of the head expander is Φ 600 mm  
 2. Standard pattern:  
 HE300S(HE300R)~HE500S(HE500R): 50×50mm in grid pattern of the inserts  
 HE600S(HE600R) and above: 100×100mm in grid pattern of the inserts



# Power Amplifier



## Smart Power Amplifier

The Smart Power amplifier is composed of the logical unit, power unit and control unit and has the advantages of intelligent manipulation, stability, reliability, flexible configuration, efficient and energy saving, compact structure and easy maintenance.

## Performance Characteristics

	<b>Customer friendly operation</b> Easy to use interface, modular system design, easy operation, multi-language switching and authority management
	<b>Powerful function</b> External connection to industrial module, customized multimedia, running log, self protection built in and platform optimization
	<b>Superior performance</b> All digital debugging, low harmonic distortion, excellent current sharing effect and multi-node monitoring.
	<b>Easy to maintain</b> System self-diagnosis, fault log and power unit adopts N+1 mode parallel operation
	<b>Test security</b> Hardware and software dual protection, output force limit, lineage protection and additional customized protections based on user requirements.

## Technical Specifications

<b>Power range</b>	0.1~1000kVA
<b>Output voltage</b>	120Vrms(rated), 150Vrms(max.)
<b>Input impedance</b>	≥10kΩ
<b>Signal-to-noise ratio</b>	≥65dB
<b>Harmonic distortion (resistive load)</b>	< 1.0% ( typical value)
<b>Output voltage measurement error</b>	≤1%
<b>Output current measurement error</b>	≤1%
<b>Output current</b>	≤4800A( 120A step increase)
<b>Output current crest factor</b>	≥3
<b>Peak power of the module unit</b>	≥150%(20kVA)
<b>DC stability</b>	Output terminal zero drift ≤50mv/8h
<b>Frequency response DC ~ 5000Hz</b>	±3dB
<b>Medium-frequency gain</b>	≥80
<b>DC / AC conversion efficiency</b>	>95%
<b>Nature of the load</b>	Optional of resistive,capacitive,inductive
<b>Parallel operation current unbalanceness</b>	≤1%



## Optional Functions

### Unattended Operation



The unattended operation function is extremely useful when performing a long duration reliability test. The user has the ability to track the equipment operating status and also has the ability to view and report the status in real time through sms (short message service) based on the parameters set by the user. This relieves the technician of the need to be present at all times and reduces labor costs while still maintaining real time monitoring.

### Authority Management



Authority to operate the test system can be set to different levels depending on the laboratory requirements. Implementation of authority levels helps to protect the specimen and the test equipment as well as maintain control and safety standards in the laboratory. Authorization levels can be set for different functions and operations of the test system.

### Force Limit Function

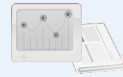

The maximum system force can be limited in real time by adjusting the system force limit parameters. Different limits can be set for each test profile. This feature can prevent large sudden force from the shaker due to external reasons that might damage the shaker or the specimen.

### History Records



Collect and store the system historical alarm information and key historical data in accordance with the user requirements. This function also provides the ability to view the historical data in real time for analysis by the user.

### Remote Control ( Direct Computer Control, Special Remote Control )



Real-time communication with the power amplifier is achieved via an Ethernet connection. This connection allows the user to perform remote control operations from more than 1 kilometer away from the system. In addition the connection provides the user with an interface to retrieve relevant information from the power amplifier as well as acquire data and perform analysis of the power amplifier.

### Composite Test Centralized Control



Combined centralized control can be performed with other third party equipment such as a temperature chamber. This control capability provides the ability to assure the test parameters and safety requirements related to the environmental testing are consistent with test requirements. The centralized control can be achieved through a variety of flexible control modes (for example: hardware interlock control, 485 bus control or Ethernet) depending on the third party equipment requirements.

### Energy-saving Mode



The user can select the optimal excitation level and power unit configuration related to the power needs of the actual test in order to save energy costs.

### Time Management



The user can set the system automatic shutdown process to begin upon completion of the test. In addition, the time management function provides the ability to view accumulated time data in real time which is convenient for scheduling and planning.

### System Self-test Source



The self-test source function provides failure source information in the event a problem occurs during the test process and a failure stops the test. This function does not require additional equipment.

# Comprehensive Environmental Test System

Temperature, Humidity, and Vibration



The integrated environmental testing system is designed to simultaneously test temperature, humidity and vibration. The test system provides the ability to define and perform tests for each of these elements at the same time. This system is widely used in reliability tests, identification tests and stress screening and often incorporates rapid temperature changes.

To ensure optimal performance of the integrated system we provide each element of the test system and integrate them into a single environmental test system. Our integration also provides the end user with savings in time, effort and cost and assures the end user that each element will work together.

### Performance Characteristics

- Dual refrigeration systems and superior refrigeration performance
- Operating system of the chamber can be dynamically monitored by the computer and automatically started up after power recovery reducing downtime
- Combined testing of vibration, temperature and humidity in a single system
- Advanced touch-screen control for easy editing
- Removable chamber bottom plate provides the ability to connect to a variety of electrodynamic shakers
- Insulated multi-layer observation window to provide an clear view into the chamber

### Main Technical Parameters

- Climate chamber capacity(L): 225 to 10000
- Humidity range: 20 to 98% R.H
- Temperature range(°C): -70 to 180
- Temperature change rate(°C / min): 1 ~ 10
- Matching vibration shaker: ES series

### Product Usage

- Integrated environmental reliability test
- Reliability growth test
- Reliability qualification test
- Product reliability acceptance test
- Routine test
- Stress screening (ESS) test

Vibration Table with Temperature Control Box Connection

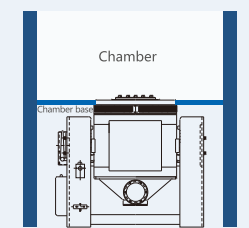

Directly connect shaker and chamber

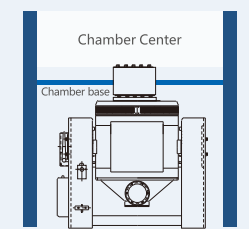

Connect shaker and chamber through connector

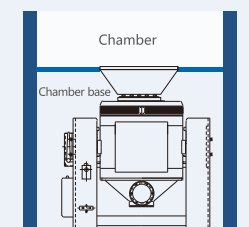

Connect shaker and chamber through head expander



# ESD Modal Shaker



## Performance Characteristics

- Permanent magnet structure
- Wideband
- High stability and reliability
- Compact structure and light weight
- High first resonance frequency
- Energy efficient

Specification	ESD-045	Specification	ESD-045
Sine force (N)	450	First resonance frequency (Hz)	4,000
Frequency range(Hz)	5 ~ 6,000	Effective mass of moving elements(kg)	0.45
Max. displacement(mm)	25	Weight (kg)	15
Max. velocity (m/s)	1.6	Dimension (L×W×H:mm)	345×225×305
Max. acceleration (m/s <sup>2</sup> )	1,000	Power amplifier	PA-1200
Screw Model	M6	Cooling type	Air Cooling
Power supply requirement	AC 220 V ±10% 50 Hz 1,300 VA		
Working environment requirement	Temperature range 0~40°C, humidity range ≤80% (non condensing)		

# Standard Shaker



## Performance Characteristics

- Load compensation
- True guidance
- Degauss coil
- Large fixing table
- Optional slip table available
- Energy efficient

Specification	ESS-050	Specification	ESS-050
Sine force (N)	500	First resonance frequency (Hz)	7,000
Frequency range(Hz)	5 ~ 10,000	Armature table diameter(mm)	120
Max. displacement(mm)	16	Weight (kg)	118
Max. velocity (m/s)	1.2	Dimension (L×W×H:mm)	400×350×465
Max. acceleration (m/s <sup>2</sup> )	300	Power amplifier	PA-1200
Max. load(kg)	20	Cooling type	Built-in Blower
Effective mass of moving elements(kg)	1.25	Power supply requirement	AC 220 V ±10% 50 Hz 1,300 VA
Working environment requirement	Temperature range 0~40°C, humidity range ≤80% (non condensing)		

# Hydraulic Vertical Shock Tester



## Description

The hydraulic vertical shock test system converts high pressure liquid energy into kinetic energy to create reciprocating movement of the element through an electro-hydraulic servo valve. The energy conversion and amplification is used to simulate the vibration or shock encountered in the actual usage environment. The intent of the testing is to optimize the product structure to withstand the actual shock environment it is expected to encounter. This test solution is commonly used in automotive, packaging, construction and steel structure as well as aerospace mechanical and electrical products.

## Performance Characteristics

- Multiple guidance columns integrated with the hydraulic balance lifting system to ensure stable lifting without noise
- Optimized of the cast aluminum magnesium alloy table which features high stiffness and low amounts of high frequency clutter
- Built-in hydraulic braking mechanism with strong braking force to effectively prevent secondary rebound
- Digital lift height feedback control system to ensure shock repeatability
- The self-buffering base is designed to greatly reduce transmission of the shock force into the ground and allows the system to be placed directly on the floor of any standard mechanical industrial plant

Model	SY10-5	SY10-25	SY10-50	SY10-100	SY10-200	*SY10-500	*SY10-1000									
Specification																
Max. payload (kg)	5	25	50	100	200	500	1000									
Table size(mm)	200×200	300×350	500×500	500×500	600×800	800×1,000	1,000×1,200									
Shock waveform	① ②	① ②	① ② ③	① ② ③	① ② ③	① ② ③	① ② ③									
Shock acceleration (m/s <sup>2</sup> )	50 ~ 30,000	150 ~ 1,000	30 ~ 15,000	150 ~ 1,000	100 ~ 12,000	150 ~ 1,000	300 ~ 1,000	100 ~ 4,000	150 ~ 600	300 ~ 600	100 ~ 2,500	150 ~ 500	300 ~ 500			
Pulse duration(ms)	20 ~ 0.5	18 ~ 6	60 ~ 0.8	18 ~ 6	60 ~ 1	18 ~ 6	12 ~ 6	60 ~ 1	18 ~ 6	12 ~ 6	60 ~ 3	18 ~ 6	12 ~ 6	60 ~ 4	18 ~ 6	12 ~ 6
Dimension (L×W×H:mm)	900×720×2300	1100×750×2500	1300×1000×2600	1300×1000×2600	1500×1200×2700	1800×1400×2750	1700×1480×3100									
Weight (kg)	900	1,600	2,600	2,600	5,000	8,000	10,000									
Oil source model	HYS30L3.7		HYS60L7.5			HYS200L25										
Power supply	380V 50/60Hz 2.2kW		380V 50/60Hz 3.7kW			380V 50/60Hz 7.5kW										
Control cabinet model	SCL															
Control cabinet dimension (L x W x H: mm)	670×600×1300															
Standard	GJB150 GJB360 GJB548 GB/T2423 JIG541 IEC60068-2-27															

① Half-sine ② Postpeak sawtooth ③ Trapezoid

Note: \* only for reference ,the table dimension and payload can be customized ,the parameters may change accordingly

# Pneumatic Vertical Shock/ Bump Tester

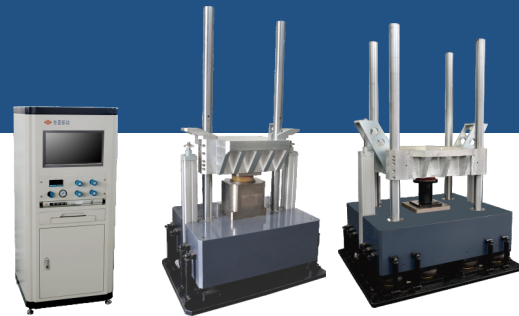

## Description

The pneumatic vertical shock and bump test system features an advanced design with a high degree of performance and automation. The tester is easy to use and has low maintenance requirements. This equipment is used for conventional half-sine wave, post-peak sawtooth wave, square wave, impact response spectrum function and other shock tests.

## Performance Characteristics

- The system utilizes a pneumatic drive which features a simple structure, high reliability and environmentally friendly operation
- Greatly improves continuous shock test efficiency with a maximum shock frequency of 100 times/min.
- Large pulse width and small overload test are easily achieved
- Higher reliability and better waveform compared with electric or hydraulic driven collision tables
- Shock velocity can be controlled by adjusting the air pressure
- The Shock DAQ series control and measurement system can be utilized and incorporated into the system for manual shock, continuous shock, single shock, interval shock and other test types
- The self-buffering base is designed to greatly reduce transmission of the shock force into the ground and allows the system to be placed directly on the floor of any standard mechanical industrial plant

Specification	Model		SY11-25			SY11-50			SY11-100			SY11-200			*SY11-500			*SY11-1000		
	①	②	①	②	③	①	②	③	①	②	③	①	②	③	①	②	③	①	②	③
Max. payload (kg)	25		50			100			200			500			1000					
Table size (mm)	300×350		500×500			500×500			600×800			800×1000			1000×1200					
Shock waveform	①	②	①	②	③	①	②	③	①	②	③	①	②	③	①	②	③	①	②	③
Shock acceleration(m/s <sup>2</sup> )	30 7,500	150 1,000	100 6,500	150 1,000	300 1,000	100 6,500	150 1,000	300 1,000	100 3,000	150 1,000	300 1,000	100 2,000	150 600	300 600	100 1,500	150 600	300 600	100 1,500	150 600	300 600
Pulse duration(ms)	60 0.8	18 ~6	60 ~1	18 ~6	12 ~6	60 ~1	18 ~6	12 ~6	60 ~2	18 ~6	12 ~6	60 ~3	18 ~6	12 ~6	60 ~4	18 ~6	12 ~6	60 ~4	18 ~6	12 ~6
Dimension (L x W x H: mm)	900×750×2000		1200×800×2000			1200×800×2000			1220×1160×2100			1800×1500×2200			1950×1650×2200					
Pressurization device size(mm)			280×280×940									360×405×940								
Weight(kg)	1,300		2,300			2,300			5,000			8,200			10,000					
Max. bump frequency (time/min)	100		80			80			50			30			30					
Control cabinet model	SCH																			
Control cabinet dimension (L x W x H: mm)	670×600×1420																			
Standard	GJB150 GJB360 GJB548 GB/T2423 JJG541 JJG497 IEC60068-2-27																			

①Half-sine ②Postpeak sawtooth ③Trapezoid

Note: \* only for reference ,the table dimension and payload can be customized ,the parameters may change accordingly

# Incline Shock Tester



Specification	Model	SY15-100	SY15-200	SY15-300	SY15-500	SY15-800	SY15-1000	SY15-1500	SY15-2000
Payload (kg)		100	200	300	500	800	1,000	1,500	2,000
*Shock plate size (mm)		1600×2000		2120×2000		2400×2000		2500×2500	
*Max. slide length (mm)		2000(To customized)		1600(To customized)		1600(To customized)		1600(To customized)	
Slope degree		10°±1°							
*Shock end velocity(m/s)		2.608	2.608	2.334	2.334	2.334	2.334	2.334	2.334
Shock velocity error		≤ ± 5%		≤ ± 5%		≤ ± 5%		≤ ± 5%	
*Carrier table size (mm)		1100×1100		1800×1800		1500×1500		2400×2400	
*Dimension (mm)		6520x1600x2500		6450x2100x3000		10500x2400x3200		11500x2500x3000	
Power supply		AC 380V±10% , 50/60Hz , 1.1kW				AC 380V±10% 50/60Hz , 2.2kW		AC 380V±10% 50/60Hz , 10kW	
Working environment		Temperature range 0~40°C, humidity range ≤80% (non condensing)							
Standard		GB/T4857.11-92 GJB2711-96							

Note: the max. shock end velocity can be 4.5m/s

\* can be customized according to customer's special requirement

# Constant Acceleration Tester



Specification	Model	SY31-50	SY31-100	SY31-100A	SY31-200	SY31-500	SY31-800	SY31-1000
Max. payload (kg)/ Position		50×2	100×2	100×2	200×2	500×2	800×2	1000×2
Acceleration(m/s <sup>2</sup> )		30~1,000	30~1,000	30~1,000	30~700	30~500	30~500	30~500
Specimen size(LxWxH:mm)		200×200×150	350×350×300	450×450×400	600×600×600	700×700×700	1000×1000×1000	1200×1200×1200
Specimen Installed radius(mm)		1,350	1,750	2,250	3,200	3,650	5,000	6,250
Turning radius(mm)		1,500	2,000	2,500	3,500	4,000	5,500	7,000
Start time(min)		≤3	≤5	≤5	≤5	≤5	≤10	≤10
Stop time(min)		≤3	≤5	≤5	≤5	≤5	≤10	≤10
Continuous working time(min)		60	60	60	60	30	30	30
Motor/Power consumption(kW)		37/47	37/47	55/70	110/165	160/200	315/390	500/610
Dimension(mm)		Ø4,000	Ø5,000	Ø6,000	Ø8,500	Ø9,500	Ø13,000	Ø16,000
Current collector(optional)		60rings 500V 5A						
Weight(kg)		2,800	3,000	3,500	10,000	13,000	25,000	35,000
Power supply		Three phase 380V, 50/60 Hz						
Measure & control system		IPC Control						
Control cabinet model		SCH						
Control cabinet demension(LxWxH: mm)		670x600x1420						
Standard		GJB150 GJB360 GB/T2423 MIL-STD-810F IEC68-2-7						
Working environment		Temperature range 0~40°C, humidity range ≤80% (non condensing)						

Note: specimen installed radius, current collector, control accuracy can be configured according to standard or customer's requirement